

California Proposition 65 Warning

WARNING: This product contains or emits chemicals known to the state of California to cause cancer and birth defects or other reproductive harm.

Event Data Recorders

This vehicle is equipped with an event data recorder (EDR).

The main purpose of an EDR is to record, in certain crash or near crash-like situations, such as an air bag deployment or hitting a road obstacle, data that will assist in understanding how a vehicle's systems performed. **The EDR is designed to record data related to vehicle dynamics and safety systems for a short period of time, typically 30 seconds or less. The EDR in this vehicle is designed to record such data as:**

- **How various systems in your vehicle were operating;**
- **Whether or not the driver and passenger safety belts were buckled/fastened;**
- **How far (if at all) the driver was depressing the accelerator and/or brake pedal; and,**
- **How fast the vehicle was traveling.**

These data can help provide a better understanding of the circumstances in which crashes and injuries occur. NOTE: EDR data are recorded by your vehicle only if a non-trivial crash situation occurs; no data are recorded by the EDR under normal driving conditions and no personal data (e.g., name, gender, age, and crash location) are recorded. However, other parties, such as law enforcement, could combine the EDR data with the type of personally identifying data routinely acquired during a crash investigation.

To read data recorded by an EDR, special equipment is required, and access to the vehicle or the EDR is needed. In addition to the vehicle manufacturer, other parties, such as law enforcement, that have the special equipment, can read the information if they have access to the vehicle or the EDR.

The data belongs to the vehicle owner and may not be accessed by anyone else except as legally required or with the permission of the vehicle owner.

Service Diagnostic Recorders

This vehicle is equipped with service-related devices that record information about powertrain performance. The data can be used to verify emissions law requirements and/or help technicians diagnose and solve service problems. It may also be combined with data from other sources for research purposes, but it remains confidential.

California Perchlorate Contamination Prevention Act

The airbags, seat belt tensioners, and CR type batteries in this vehicle may contain perchlorate materials - special handling may apply. See www.dtscc.ca.gov/hazardouswaste/perchlorate/

As you read this manual, you will find information that is preceded by a **NOTICE** symbol. This information is intended to help you avoid damage to your vehicle, other property, or the environment.

A Few Words About Safety

Your safety, and the safety of others, is very important. And operating this vehicle safely is an important responsibility.

To help you make informed decisions about safety, we have provided operating procedures and other information on labels and in this manual. This information alerts you to potential hazards that could hurt you or others.

Of course, it is not practical or possible to warn you about all the hazards associated with operating or maintaining your vehicle. You must use your own good judgment.

You will find this important safety information in a variety of forms, including:

- **Safety Labels** - on the vehicle.
- **Safety Messages** - preceded by a safety alert symbol  and one of three signal words: **DANGER**, **WARNING**, or **CAUTION**. These signal words mean:

 **DANGER**

You **WILL** be **KILLED** or **SERIOUSLY HURT** if you don't follow instructions.

 **WARNING**

You **CAN** be **KILLED** or **SERIOUSLY HURT** if you don't follow instructions.

 **CAUTION**

You **CAN** be **HURT** if you don't follow instructions.

- **Safety Headings** - such as Important Safety Precautions.
- **Safety Section** - such as Safe Driving.
- **Instructions** - how to use this vehicle correctly and safely.

This entire book is filled with important safety information - please read it carefully.

FarmaSOS.com

This owner's manual should be considered a permanent part of the vehicle and should remain with the vehicle when it is sold.

This owner's manual covers all models of your vehicle. You may find descriptions of equipment and features that are not on your particular model.

Images throughout this owner's manual (including the front cover) represent features and equipment that are available on some, but not all, models. Your particular model may not have some of these features.

This owner's manual is for vehicles sold in the United States and Canada.

The information and specifications included in this publication were in effect at the time of approval for printing. Honda Motor Co., Ltd. reserves the right, however, to discontinue or change specifications or design at any time without notice and without incurring any obligation.

➤ Safe Driving P. 27

For Safe Driving P. 28 Seat Belts P. 32 Airbags P. 39

➤ Instrument Panel P. 67

Indicators P. 68 Gauges and Displays P. 89

➤ Controls P. 105

Clock P. 106 Locking and Unlocking the Doors P. 108
Opening and Closing the Moonroof* P. 130
Adjusting the Seats P. 148
Climate Control System* P. 169

➤ Features P. 173

Audio System P. 174 Audio System Basic Operation P. 180, 202, 235
Customized Features P. 298 HomeLink® Universal Transceiver* P. 336

➤ Driving P. 415

Before Driving P. 416 Towing a Trailer P. 421
Refueling P. 479 Fuel Economy P. 481

➤ Maintenance P. 483

Before Performing Maintenance P. 484 Maintenance Minder™ P. 487
Checking and Maintaining Wiper Blades P. 521
Heating and Cooling System*/Climate Control System* Maintenance P. 535

➤ Handling the Unexpected P. 541

Tools P. 542 If a Tire Goes Flat P. 543
Overheating P. 556 Indicator, Coming On/Blinking P. 558

➤ Information P. 567

Specifications P. 568 Identification Numbers P. 572
Emissions Testing P. 575 Warranty Coverages P. 577

Contents

Child Safety P. 52	Exhaust Gas Hazard P. 64	Safety Labels P. 65
Opening and Closing the Trunk P. 120	Security System P. 124	Opening and Closing the Windows P. 127
Operating the Switches Around the Steering Wheel P. 131		Adjusting the Mirrors P. 146
Interior Lights/Interior Convenience Items P. 156		Heating and Cooling* P. 166
Audio Error Messages P. 288	General Information on the Audio System P. 294	
<i>Bluetooth</i> ® HandsFreeLink® P. 338, 375	Compass* P. 413	
When Driving P. 425	Braking P. 472	Parking Your Vehicle P. 476
Accessories and Modifications P. 482		
Maintenance Under the Hood P. 495	Replacing Light Bulbs P. 511	
Checking and Maintaining Tires P. 523	Battery P. 532	Remote Transmitter Care P. 533
Cleaning P. 536		
Engine Does Not Start P. 549	Jump Starting P. 552	Shift Lever Does Not Move P. 555
Fuses P. 562	Emergency Towing P. 565	
Devices that Emit Radio Waves P. 573	Reporting Safety Defects P. 574	
Authorized Manuals P. 579	Customer Service Information P. 580	

Quick Reference Guide P. 4

Safe Driving P. 27

Instrument Panel P. 67

Controls P. 105

Features P. 173

Driving P. 415

Maintenance P. 483

Handling the Unexpected P. 541

Information P. 567

Index P. 584

Visual Index

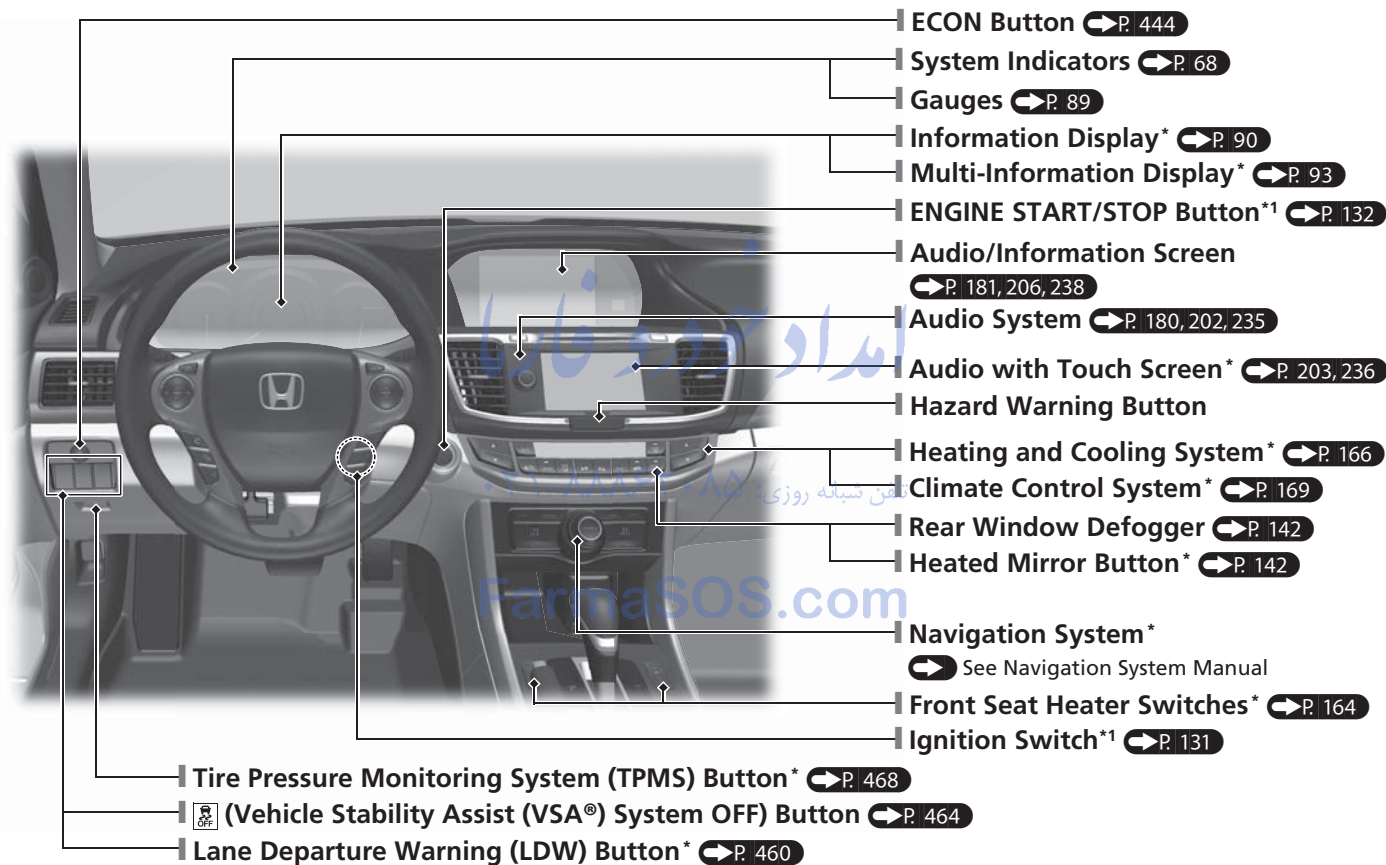

*1: Models with the smart entry system have an **ENGINE START/STOP** button instead of an ignition switch.

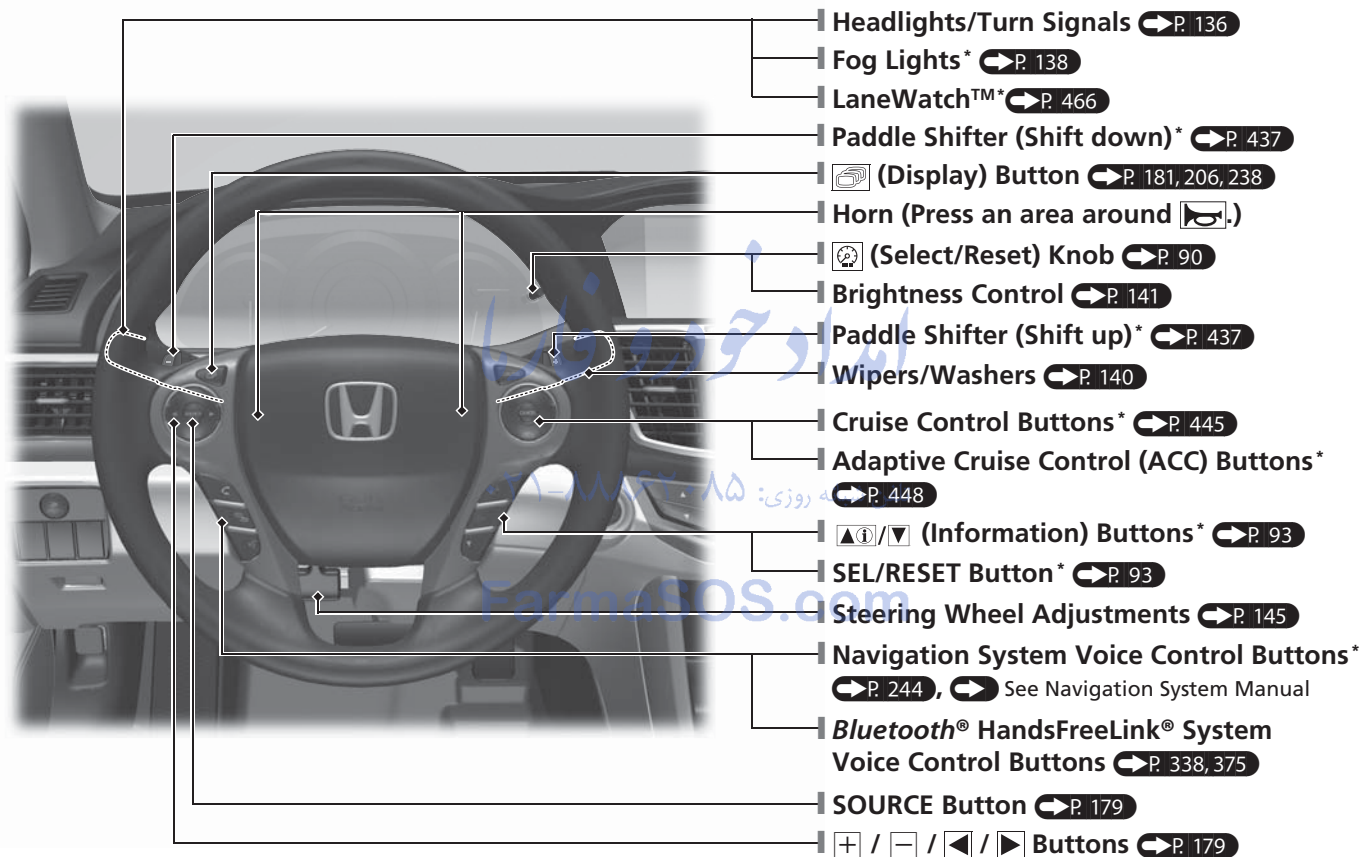

Visual Index

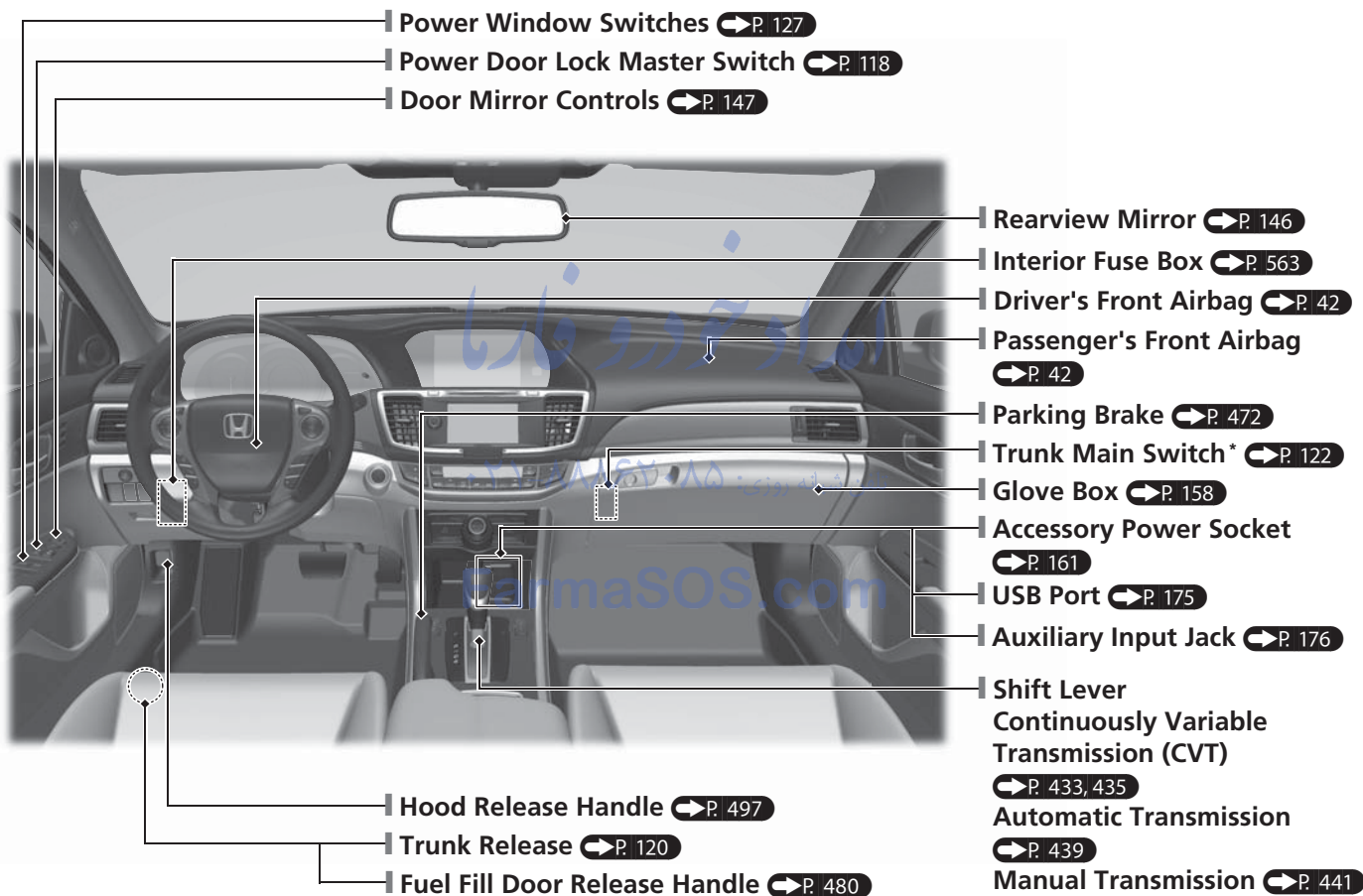

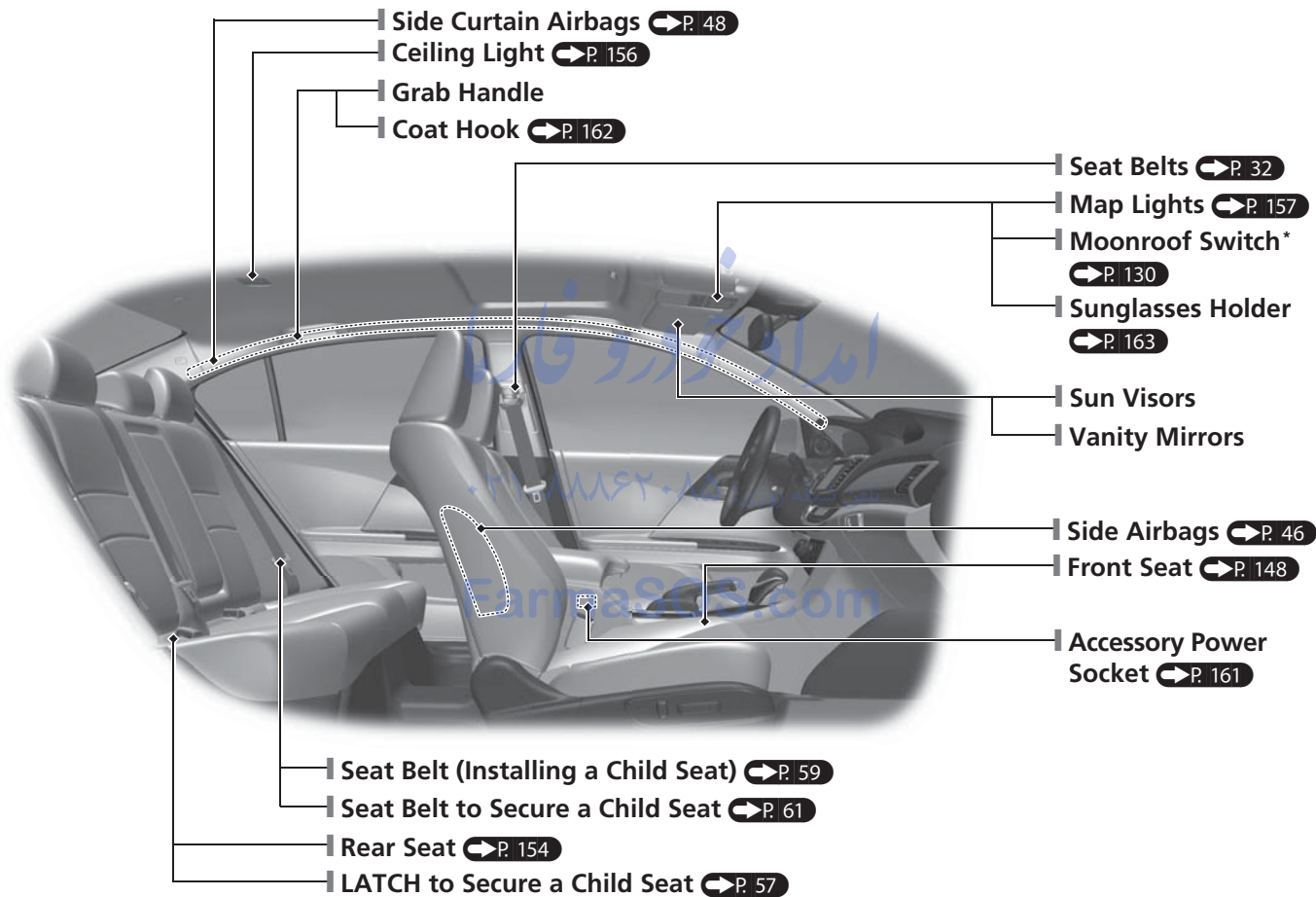

* Not available on all models

Visual Index

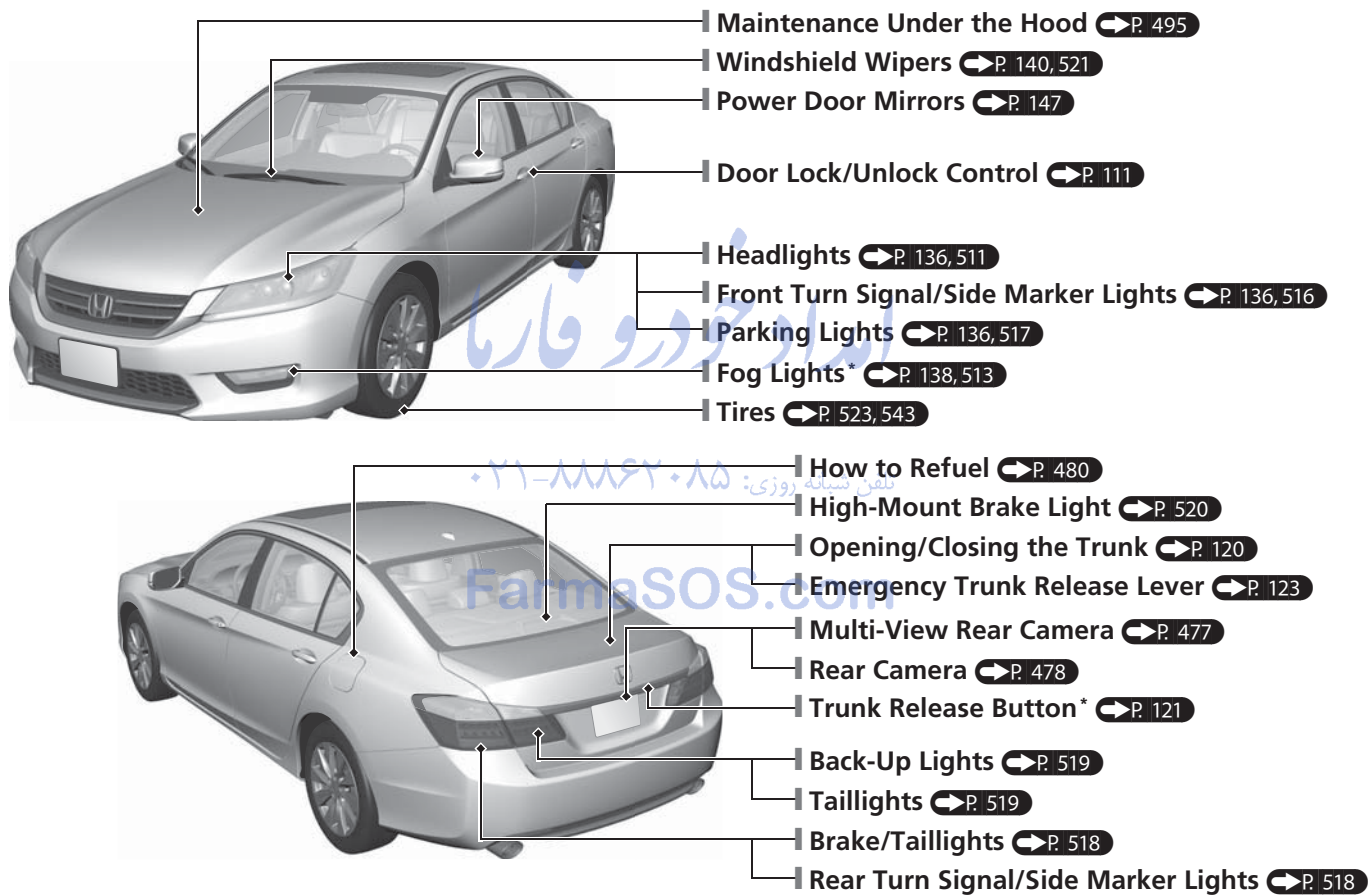

Eco Assist System P. 444

Ambient Meter

- Changes color to reflect your driving style.
Green: Fuel efficient driving
Light green: Moderate acceleration/ deceleration
White: Aggressive acceleration/ deceleration
- The ambient meter color changes in accordance with your brake or accelerator pedal operation.

Ambient Meter

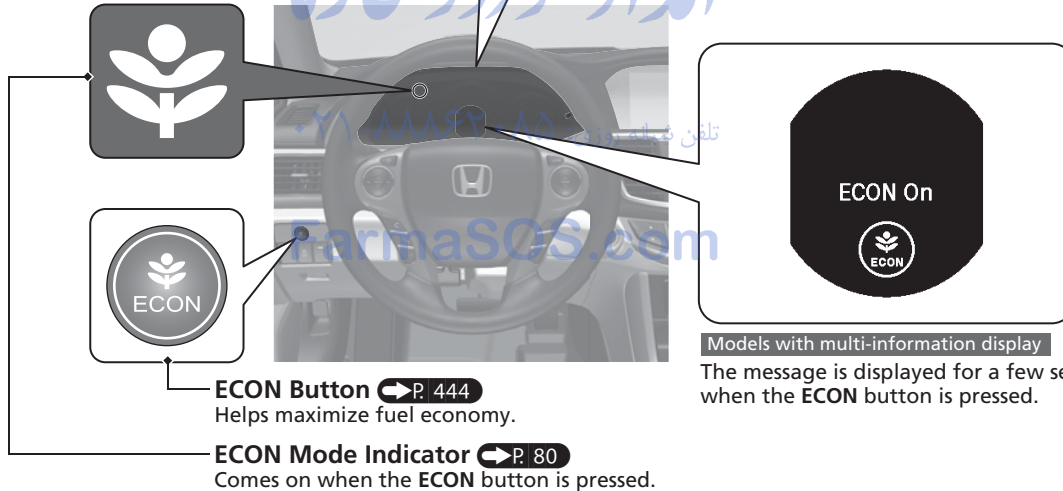
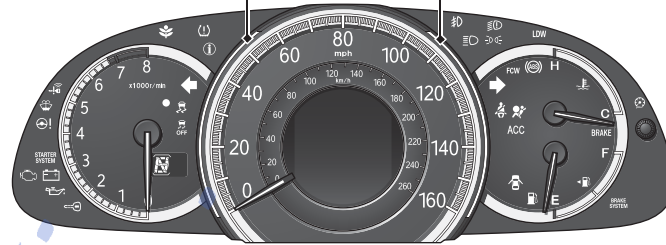

Safe Driving ↔ P. 27

Airbags ↔ P. 39

- Your vehicle is fitted with airbags to help protect you and your passengers during a moderate-to-severe collision.

Child Safety ↔ P. 52

- All children 12 and younger should be seated in the rear seat.
- Smaller children should be properly restrained in a forward-facing child seat.
- Infants must be properly restrained in a rear-facing child seat.

Exhaust Gas Hazard ↔ P. 64

- Your vehicle emits dangerous exhaust gases that contain carbon monoxide. Do not run the engine in confined spaces where carbon monoxide gas can accumulate.

Seat Belts ↔ P. 32

- Fasten your seat belt and sit upright well back in the seat.
- Check that your passengers are wearing their seat belts correctly.

Before Driving Checklist ↔ P. 31

- Before driving, check that the front seats, head restraints, steering wheel, and mirrors have been properly adjusted.















Fasten your lap belt as low as possible.

Instrument Panel ↔ P. 67



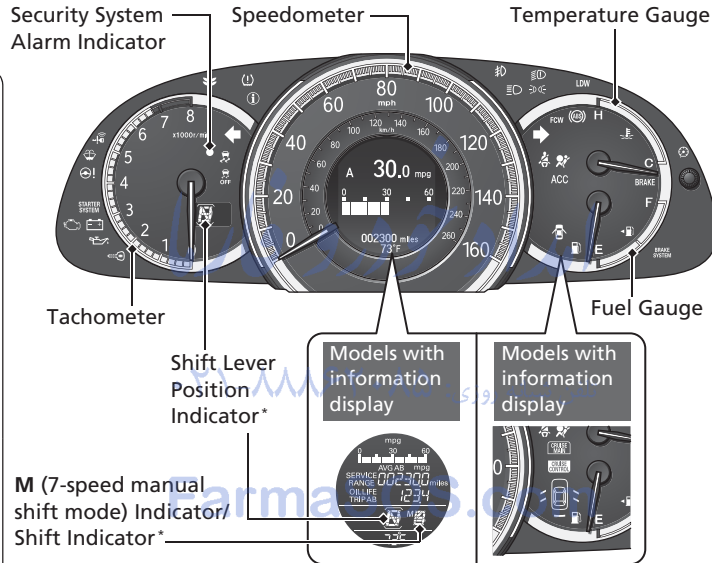

Gauges ↔ P. 89 / Information Display* ↔ P. 90 / Multi-Information Display* ↔ P. 93 / System Indicators ↔ P. 68

System Indicators



-  Malfunction Indicator Lamp
-  Low Oil Pressure Indicator
-  Charging System Indicator
-  Vehicle Stability Assist (VSA®) System Indicator
-  VSA® OFF Indicator
-  Immobilizer System Indicator
-  Smart Entry System Indicator*
- STARTER SYSTEM**
- U.S.  Starter System Indicator*
- Canada  Starter System Indicator*
-  Electric Power Steering (EPS) System Indicator
-  Washer Level Indicator*
-  System Message Indicator*
-  Maintenance Minder Indicator*















System Indicators

-  Low Tire Pressure/TPMS Indicator
-  ECON mode Indicator
-  FCW Forward Collision Warning (FCW) Indicator*
-  LDW Lane Departure Warning (LDW) Indicator*

Lights Indicators

-  Lights On Indicator
-  High Beam Indicator
-  Fog Light Indicator*
-  Light Control Indicator*

System Indicators

-  Turn Signal and Hazard Warning Indicators
-  ABS Anti-lock Brake System (ABS) Indicator
- BRAKE**
- U.S.  Parking Brake and Brake System Indicator (Red)
- Canada  Parking Brake and Brake System Indicator (Red)
- BRAKE SYSTEM**
- U.S.  Brake System Indicator (Amber)
- Canada  Brake System Indicator (Amber)
-  Door and Trunk Open Indicator
-  Low Fuel Indicator
-  Seat Belt Reminder Indicator
-  Supplemental Restraint System Indicator
-  ACC Adaptive Cruise Control (ACC) Indicator*
-  CRUISE MAIN Indicator*
-  CRUISE CONTROL Indicator*

* Not available on all models

Controls ↔ P. 105

Clock ↔ P. 106

Models without navigation system

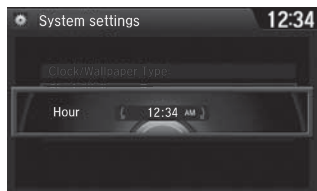

- 1 Enter the **Clock Adjustment** screen.
➔ **Adjusting the Clock** ↔ P. 106
- 2 Rotate to change hour, then press .
- 3 Rotate to change minute, then press .

Models with navigation system

The navigation system receives signals from GPS satellites, updating the clock automatically.

ENGINE START/STOP Button* ↔ P. 132

Press the button to change the vehicle's power mode.



Turn Signals ↔ P. 136 تلفن شبانه

Turn Signal Control Lever



Lights ↔ P. 136

Light Control Switches

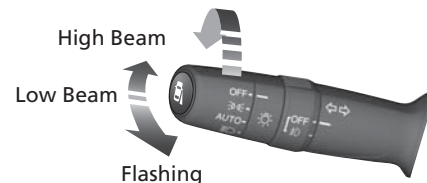

Wipers and Washers ↔ P. 140

Wiper/Washer Control Lever

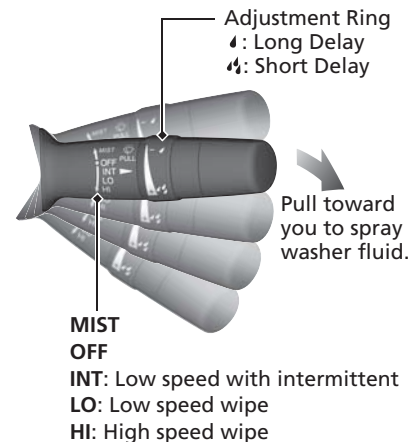

Steering Wheel P. 145

- To adjust, pull the adjustment lever towards you, adjust to the desired position, then lock the lever back in place.



Unlocking the Front Doors from the Inside

 P. 116

- Pull either front door inner handle to unlock and open it at the same time.

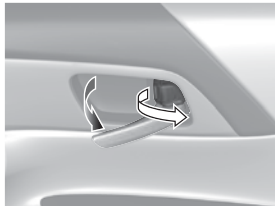

- Unlocking and opening the driver's door from the inner handle unlocks all the other doors.

Trunk P. 120

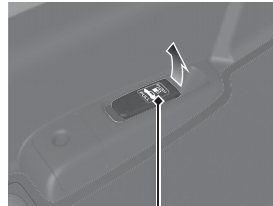

Trunk Release

- To unlock and open the trunk:
 - Pull the trunk release.
 - Press the trunk release button on the remote transmitter or the smart entry remote.
 - Press the trunk release button* on the trunk lid.

Power Door Mirrors

 P. 147

- With the ignition switch in ON *1, move the selector switch to L or R.
- Push the appropriate edge of the adjustment switch to adjust the mirror.

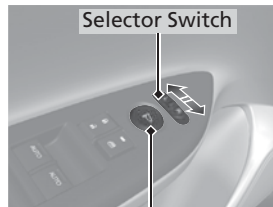

Adjustment Switch

Power Windows P. 127

- With the ignition switch in ON *1, open and close the power windows.
- If the power window lock button is in the off position, each passenger's window can be opened and closed with its own switch.
- If the power window lock button is in the on position (indicator on), each passenger's window switch is disabled.



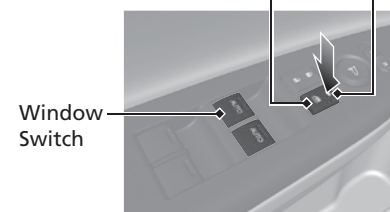



Power Window Lock Button Indicator



Window Switch



*1: Models with the smart entry system have an **ENGINE START/STOP** button instead of an ignition switch.

Heating and Cooling System* P. 166

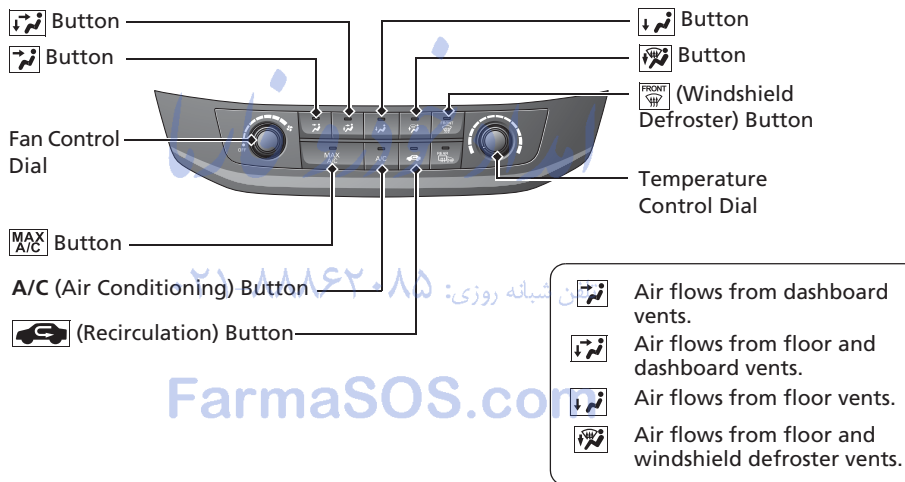
- Rotate the fan control dial to adjust the fan speed and airflow.
- Press the Mode buttons ( /  /  / ) to select the vents air flows from.
- Rotate the temperature control dial to adjust the temperature.
- Use the  button for maximum cool setting.
- Rotate the fan control dial to **OFF** to turn the system off.
- Press the  button to defrost the windshield.



Climate Control System* P. 169



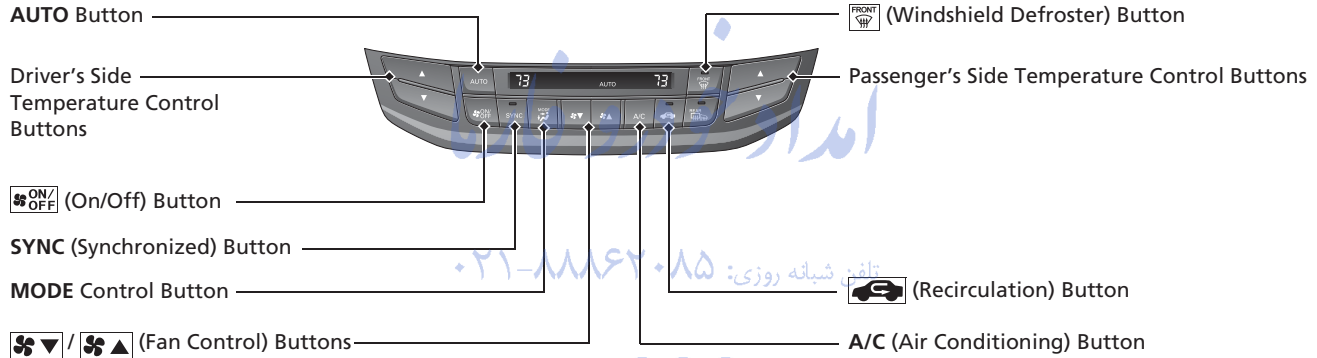

- Press the **AUTO** button to activate the climate control system.
- Press the  button to turn the system on or off.
- Press the  button to defrost the windshield.

Models with navigation system

The climate control system is voice operable.  P. 244



تلفن شبانه روزی: ۰۲۱-۸۸۶۲۰۸۵
FarmaSOS.com

-  Air flows from dashboard vents and back of the center console*.
-  Air flows from floor and dashboard vents, and back of the center console*.
-  Air flows from floor vents.
-  Air flows from floor and windshield defroster vents.

* Not available on all models

Features ➔ P. 173

Audio Remote Controls

➔ P. 179

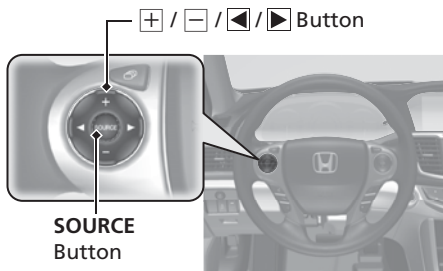

- **+ / -** Button
Press to adjust the volume up/down.
- **SOURCE** Button
Press to change the audio mode: FM/AM/CD/SiriusXM®/HDD*/USB/iPod/Bluetooth/Pandora®*/Aha™*/AUX.
- **◀ / ▶** Button
Radio: Press to change the preset station.
Press and hold to select the next or previous strong station.
CD/HDD*/USB device:
Press to skip to the beginning of the next song or return to the beginning of the current song.
Press and hold to change a folder.

Audio System ➔ P. 180, 202, 235

Models with one display ➔ P. 180

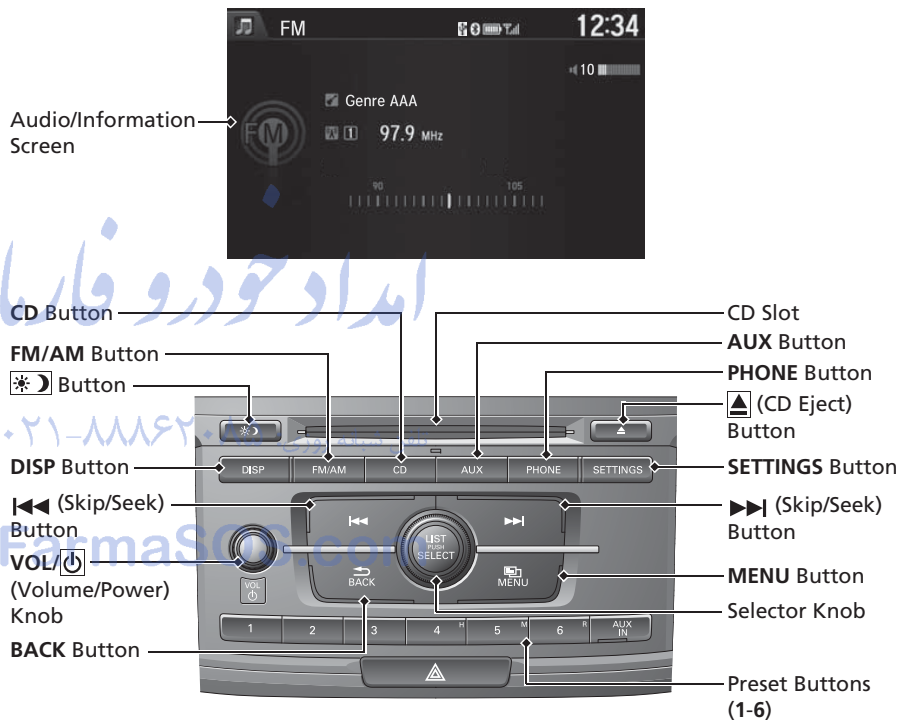

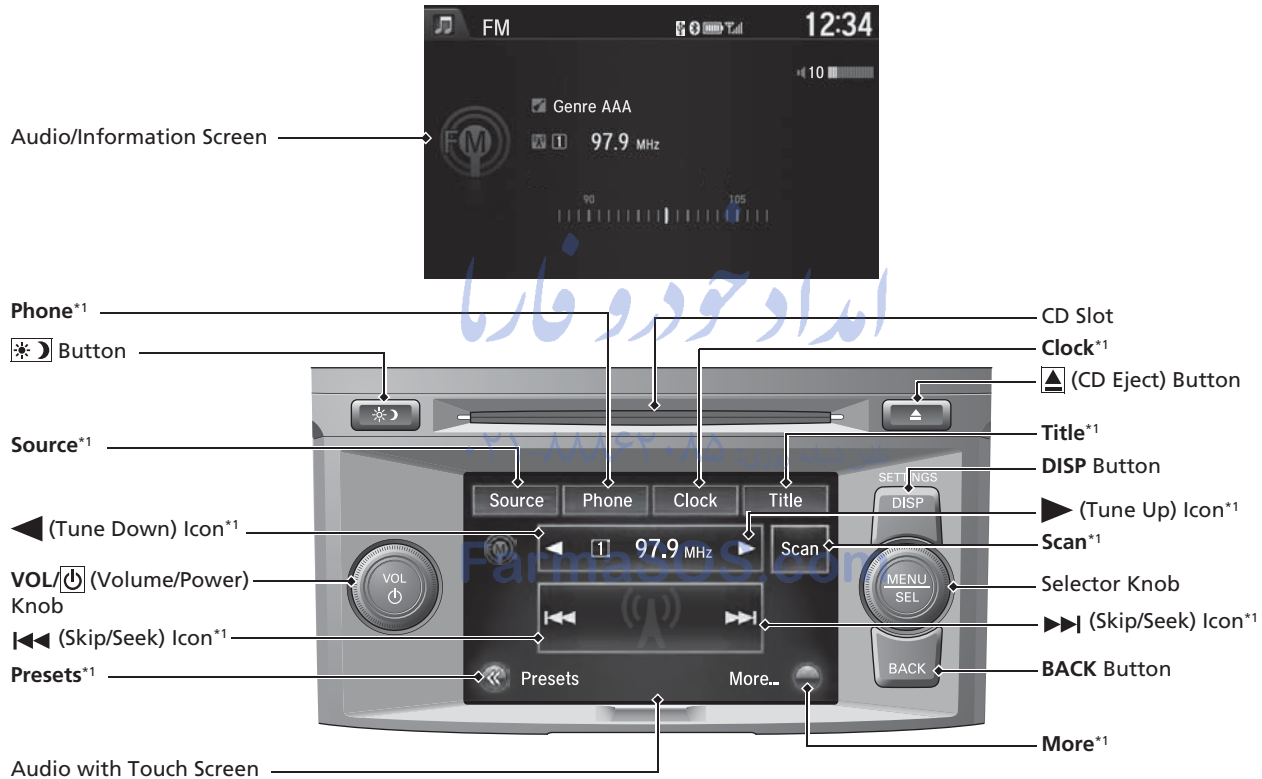

*1:Icons that appear on the screen vary by the source selected.

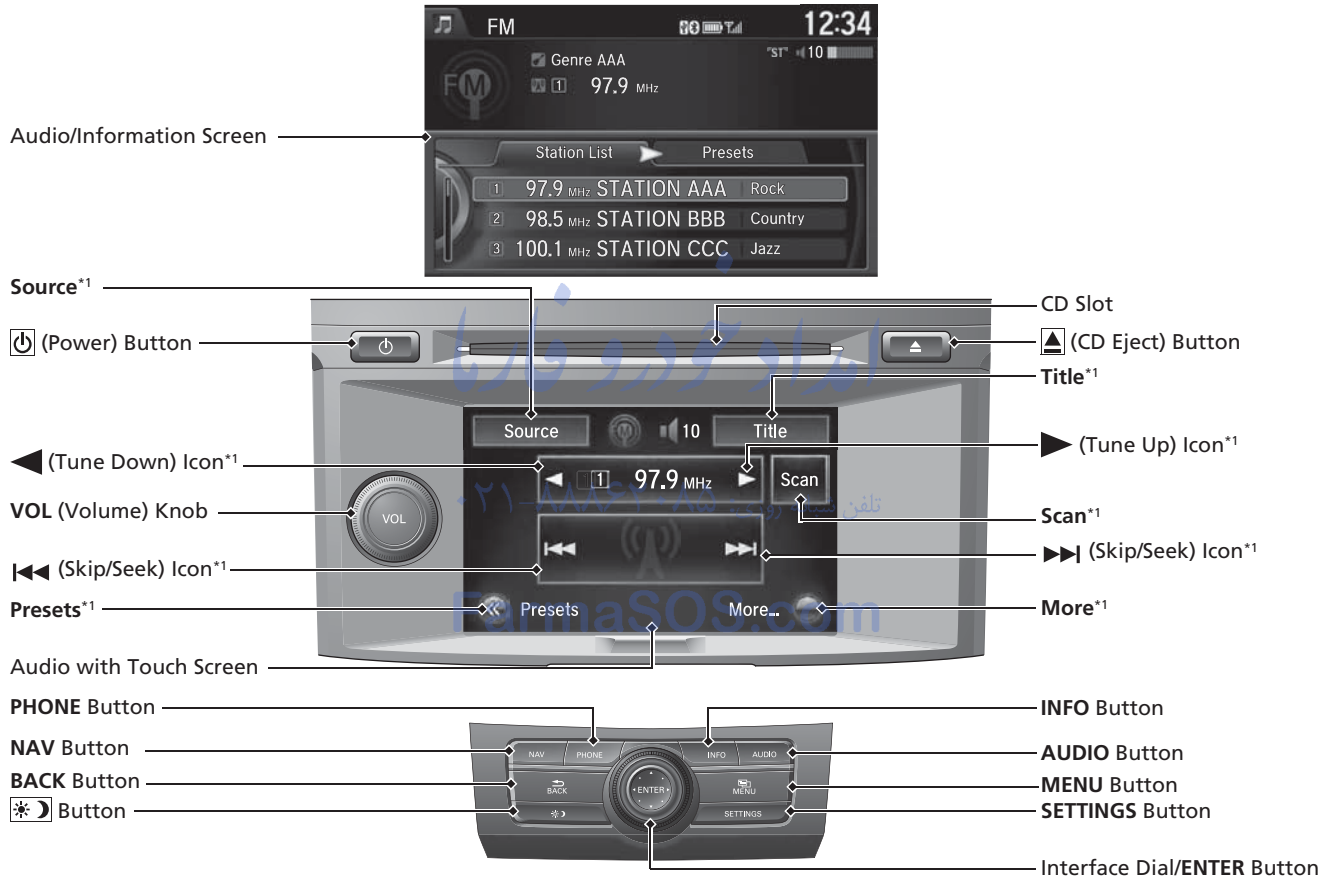

*1:Icons that appear on the screen vary by the source selected.

Driving

Manual Transmission*

Continuously Variable Transmission (CVT)*

- Shift to **P** and depress the brake pedal when starting the engine.
- **Shifting**

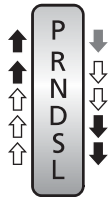

Models without paddle shifter

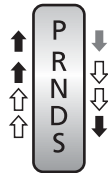

Models with paddle shifter



Depress the brake pedal and press the release button to move out of **P**.

Press the release button to move the shift lever.

Move the shift lever without pressing the release button.

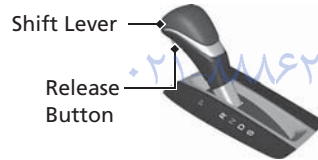

P **Park**
Turn off or start the engine.
Transmission is locked.

R **Reverse**
Used when reversing.

N **Neutral**
Transmission is not locked.

D **Drive**
● Normal driving.
● On models with paddle shifter, 7-speed mode can be used temporarily.



S **Drive (S)**
● Better acceleration.
● Increased engine braking.
● Going up or down hills.
● On models with paddle shifter, 7-speed manual shift mode can be used.

L **Low***
● Further increased engine braking.
● Going up or down hills.

7-Speed Manual Shift Mode

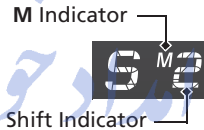
- Allows you to manually shift the transmission up or down without removing your hands from the steering wheel.



Shift Down  Shift Up 
Paddle Shifter Paddle Shifter

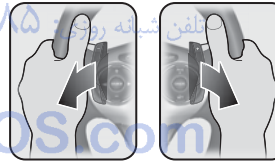

When the shift lever is in **S**

- Pulling a paddle shifter changes the mode from continuously variable transmission (CVT) to 7-speed manual shift mode.
- The **M** indicator and the selected speed number are displayed in the shift indicator.

When the shift lever is in **D**

- Pulling a paddle shifter temporarily changes the mode from continuously variable transmission (CVT) to 7-speed manual shift mode. The selected speed number is displayed in the shift indicator.



* Not available on all models

VSA® OFF Button P. 465

- The vehicle stability assist (VSA®) system helps stabilize the vehicle during cornering, and helps maintain traction while accelerating on loose or slippery road surfaces.
- VSA® comes on automatically every time you start the engine.
- To turn VSA® on or off, press and hold the button until you hear a beep.

Cruise Control P. 445

- Cruise control allows you to maintain a set speed without keeping your foot on the accelerator pedal.
- To use cruise control, press the **CRUISE** button, then press the **-/SET** button once you have achieved the desired speed (above 25 mph or 40 km/h).

Tire Pressure Monitoring System (TPMS) P. 468

- Detects a change in tire conditions and overall dimensions due to decrease in tire pressures.
- The TPMS is turned on automatically every time you start the engine.
- A calibration procedure must be performed when certain conditions arise.

Refueling P. 479

Fuel recommendation: Unleaded gasoline with a pump octane number 87 or higher required

Fuel tank capacity: 17.2 US gal (65 L)

- 1 Push the fuel fill door release handle.

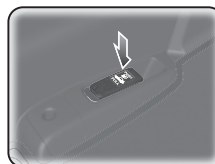

- 2 Turn the fuel fill cap slowly to remove the cap.

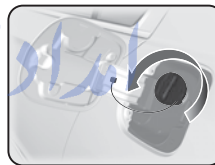

- 3 Place the cap in the holder on the fuel fill door.

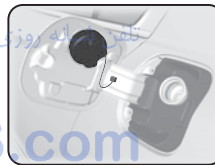

- 4 After refueling, screw the cap back on until it clicks at least once.



Maintenance ➔ P. 483

Under the Hood ➔ P. 495

- Check engine oil, engine coolant, and windshield washer fluid. Add when necessary.
- Check brake fluid and clutch* fluid.
- Check the battery condition monthly.

- 1 Pull the hood release handle under the corner of the dashboard.



- 2 Locate the hood latch lever, pull the lever up, and lift up the hood.



- 3 When finished, close the hood and make sure it is firmly locked in place.

Wiper Blades ➔ P. 521

- Replace blades if they leave streaks across the windshield.



Tires ➔ P. 523

- Inspect tires and wheels regularly.
- Check tire pressures regularly.
- Install snow tires for winter driving.

Lights ➔ P. 511

- Inspect all lights regularly.

FarmaSOS.com

تلفن شبانه روزی: ۰۸۵-۸۸۸۶۲۰۲۱

Handling the Unexpected ➔ P. 541

Flat Tire ➔ P. 543

- Park in a safe location and replace the flat tire with the compact spare tire in the trunk.



Engine Won't Start ➔ P. 549

- If the battery is dead, jump start using a booster battery.

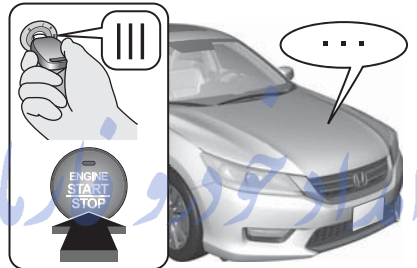

Overheating ➔ P. 556

- Park in a safe location. If you do not see steam under the hood, open the hood, and let the engine cool down.



Indicators Come On

➔ P. 558

- Identify the indicator and consult the owner's manual.

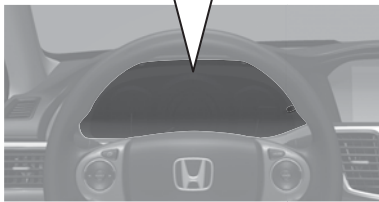

Blown Fuse ➔ P. 562

- Check for a blown fuse if an electrical device does not operate.

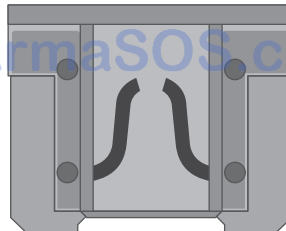

Emergency Towing

➔ P. 565

- Call a professional towing service if you need to tow your vehicle.



What to Do If

Q The ignition switch does not turn from **0** to **I***1. Why?

A

- The steering wheel may be locked.

Models without smart entry system

- Try to turn the steering wheel left and right while turning the ignition key.

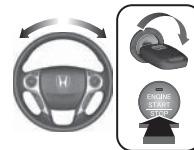

Models with smart entry system*2

- Move the steering wheel left and right while pressing the **ENGINE START/STOP** button at the same time.

Q The ignition switch does not turn from **I** to **0***1 and I cannot remove the key. Why?

A The shift lever should be moved to **P**.



تلفن شبانه روزی: ۰۲۱-۸۸۸۶۲۰۸۵

Q Why does the brake pedal pulsate slightly when applying the brakes?

A This can occur when the ABS activates, and does not indicate a problem. Apply firm, steady pressure on the brake pedal. Never pump the brake pedal.

*1: Models with the smart entry system have an **ENGINE START/STOP** button instead of an ignition switch.

*2: Except U.S. automatic transmission/CVT models

Q The rear door cannot be opened from inside the vehicle. Why?

A Check if the childproof lock is in the lock position. If so, open the rear door with the outside door handle.
To cancel this function, push the lever to the unlock position.

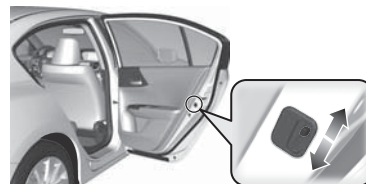

Q Why do the doors lock after I unlocked the doors using a remote transmitter?

A If you do not open the doors within 30 seconds, the doors are relocked automatically for security.

Q Why does the beeper sound when I open the driver's door?

A The beeper sounds when:

- The key is left in the ignition switch*.
- The power mode* is in ACCESSORY.
- The exterior lights are left on.

Q Why does the beeper sound when I start driving?

A The beeper sounds when:

- Driver and/or front passenger are not wearing their seat belts.
- The parking brake lever is not fully released.

Q Why do I hear a screeching sound when I apply the brake pedal?

A The brake pads may need to be replaced. Have your vehicle inspected by a dealer.

امداد خودرو فارما

تلفن شبانه روزی: ۰۲۱-۸۸۸۶۲۰۸۵

FarmaSOS.com

Safe Driving

You can find many safety recommendations throughout this chapter, and throughout this manual.

امداد خودرو فارما

تلفن شبانه روزی: ۰۲۱-۸۸۸۶۲۰۸۵

FarmSOS.com

For Safe Driving

Important Safety Precautions	28
Your Vehicle's Safety Features.....	30

Seat Belts

About Your Seat Belts.....	32
Fastening a Seat Belt.....	35
Seat Belt Inspection.....	38

Airbags

Airbag System Components.....	39
Types of Airbags	42
Front Airbags (SRS)	42
Side Airbags.....	46

Side Curtain Airbags.....	48
Airbag System Indicators.....	49
Airbag Care	51

Child Safety

Protecting Child Passengers	52
Safety of Infants and Small Children	54
Safety of Larger Children	62

Exhaust Gas Hazard

Carbon Monoxide Gas.....	64
--------------------------	----

Safety Labels

Label Locations	65
-----------------------	----

The following pages explain your vehicle's safety features and how to use them properly. The safety precautions below are ones that we consider to be among the most important.

Important Safety Precautions

■ Always wear your seat belt

A seat belt is your best protection in all types of collisions. Airbags are designed to supplement seat belts, not replace them. So even though your vehicle is equipped with airbags, make sure you and your passengers always wear your seat belts, and wear them properly.

■ Restrain all children

Children ages 12 and under should ride properly restrained in a back seat, not the front seat. Infants and small children should be restrained in a child seat. Larger children should use a booster seat and a lap/shoulder seat belt until they can use the belt properly without a booster seat.

■ Be aware of airbag hazards

While airbags can save lives, they can cause serious or fatal injuries to occupants who sit too close to them, or are not properly restrained. Infants, young children, and short adults are at the greatest risk. Be sure to follow all instructions and warnings in this manual.

■ Don't drink and drive

Alcohol and driving don't mix. Even one drink can reduce your ability to respond to changing conditions, and your reaction time gets worse with every additional drink. So don't drink and drive, and don't let your friends drink and drive, either.

» Important Safety Precautions

Some states, provinces and territories prohibit the use of cell phones other than hands-free devices by the driver while driving.

■ Pay appropriate attention to the task of driving safely

Engaging in cell phone conversation or other activities that keep you from paying close attention to the road, other vehicles, and pedestrians could lead to a crash. Remember, situations can change quickly, and only you can decide when it is safe to divert some attention away from driving.

■ Control your speed

Excessive speed is a major factor in crash injuries and deaths. Generally, the higher the speed, the greater the risk, but serious injuries can also occur at lower speeds. Never drive faster than is safe for current conditions, regardless of the maximum speed posted.

■ Keep your vehicle in safe condition

Having a tire blowout or a mechanical failure can be extremely hazardous.

To reduce the possibility of such problems, check your tire pressures and condition frequently, and perform all regularly scheduled maintenance.

امداد خودرو فارما
تلفن شبانه روزی: ۰۸۵۰۳۰۰۰۰۰۰۰۰
FarmaSOS.com

Your Vehicle's Safety Features

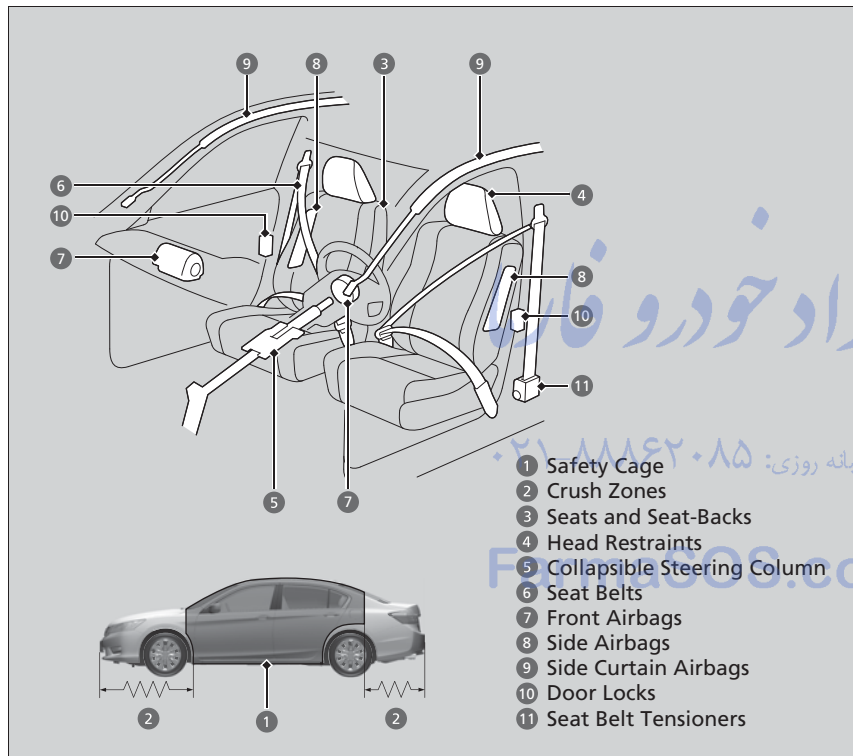

►► Your Vehicle's Safety Features

Your vehicle is equipped with many features that work together to help protect you and your passengers during a crash.

Some features do not require any action on your part. These include a strong steel framework that forms a safety cage around the passenger compartment, front and rear crush zones, a collapsible steering column, and tensioners that tighten the front seat belts in a sufficient crash.

However, you and your passengers cannot take full advantage of these features unless you remain seated in the correct position and always wear your seat belts. In fact, some safety features can contribute to injuries if they are not used properly.

The following checklist will help you take an active role in protecting yourself and your passengers.

Safety Checklist

For the safety of you and your passengers, make a habit of checking these items each time before you drive.

- After everyone has entered the vehicle, be sure all doors are closed and locked. Locking the doors helps prevent an occupant from being ejected and an outsider from unexpectedly opening a door.
 - **Locking/Unlocking the Doors from the Inside** P. 116
- Adjust your seat to a position suitable for driving. Be sure the front seats are adjusted as far to the rear as possible while allowing the driver to control the vehicle. Sitting too close to a front airbag can result in serious or fatal injury in a crash.
 - **Adjusting the Seats** P. 148
- Adjust head restraints to the proper position. Head restraints are most effective when the center of the head restraint aligns with the center of your head. Taller persons should adjust their head restraint to the highest position.
 - **Adjusting the Head Restraints** P. 151
- Always wear your seat belt, and make sure you wear it properly. Confirm that any passengers are properly belted as well.
 - **Fastening a Seat Belt** P. 35
- Protect children by using seat belts or child seats according to a child's age, height and weight.
 - **Child Safety** P. 52

Safety Checklist

If the door and trunk open indicator is on, a door and/or the trunk is not completely closed. Close all doors and the trunk tightly until the indicator goes off.

➤ **Door and Trunk Open Indicator** P. 74

Models with information display

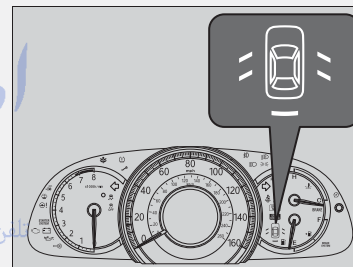

Models with multi-information display

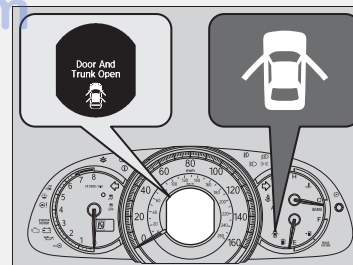

About Your Seat Belts

Seat belts are the single most effective safety device because they keep you connected to the vehicle so that you can take advantage of many built-in safety features. They also help keep you from being thrown against the inside of the vehicle, against other passengers, or out of the vehicle. When worn properly, seat belts also keep your body properly positioned in a crash so that you can take full advantage of the additional protection provided by the airbags.

In addition, seat belts help protect you in almost every type of crash, including:

- frontal impacts
- side impacts
- rear impacts
- rollovers

■ Lap/shoulder seat belts

All five seating positions are equipped with lap/shoulder seat belts with emergency locking retractors. In normal driving the retractor lets you move freely while keeping some tension on the belt. During a collision or sudden stop the retractor locks to restrain your body. The rear seat belts also have a lockable retractor for use with child seats.

- **Installing a Child Seat with a Lap/Shoulder Seat Belt** P. 59

➤ About Your Seat Belts

⚠ WARNING

Not wearing a seat belt properly increases the chance of serious injury or death in a crash, even though your vehicle has airbags.

Be sure you and your passengers always wear seat belts and wear them properly.

Seat belts cannot completely protect you in every crash. But in most cases, seat belts can reduce your risk of serious injury.

Most states and all Canadian provinces and territories require you to wear seat belts.

The emergency locking retractor may lock if you lean forward too quickly. Slower movements will allow the belt to extend fully without locking.

■ Proper use of seat belts

Follow these guidelines for proper use:

- All occupants should sit upright, well back in the seat, and remain in that position for the duration of the trip. Slouching and leaning reduce the effectiveness of the belt and can increase the chance of serious injury in a crash.
- Never place the shoulder part of a lap/shoulder seat belt under your arm or behind your back. This could cause very serious injuries in a crash.
- Two people should never use the same seat belt. If they do, they could be very seriously injured in a crash.
- Do not put any accessories on the seat belts. Devices intended to improve comfort or reposition the shoulder part of a seat belt can reduce the protective capability and increase the chance of serious injury in a crash.

■ Seat Belt Reminder

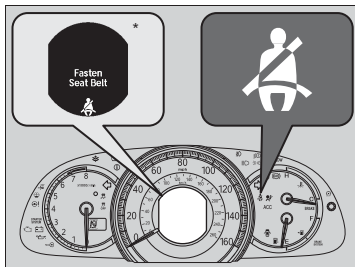

Your vehicle monitors front seat belt use. If the ignition switch is turned to ON **II**^{*1} before the driver's seat belt is fastened, the beeper will sound and the indicator will blink. If the driver does not fasten the belt before the beeper stops, the indicator will remain on.

The beeper will also periodically sound and the indicator will blink while driving until the driver's and front passenger's seat belts are fastened.

*1: Models with the smart entry system have an **ENGINE START/STOP** button instead of an ignition switch.

* Not available on all models

▶▶ About Your Seat Belts

If a rear seat passenger moves around and extends the seat belt, the lockable retractor may activate. If this happens, release the retractor by unfastening the seat belt and allow the belt to retract completely. Then refasten the belt.

▶▶ Seat Belt Reminder

The indicator will also come on if a front passenger does not fasten their seat belt within six seconds after the ignition switch is turned to ON **II**^{*1}. When no one is sitting in the front passenger's seat, the indicator will not come on and the beeper will not sound. The indicator also may not come on and the beeper may not sound when the occupant is not heavy enough to trigger the weight sensor. Such occupants (e.g., infants and smaller children) should be moved to the rear seat as a deploying front airbag likely will injure or kill them.

▶▶ **Protecting Child Passengers** P. 52

Continued

Automatic Seat Belt Tensioners

The front seats are equipped with automatic seat belt tensioners to enhance safety.

The tensioners automatically tighten the front seat belts during a moderate-to-severe frontal collision, sometimes even if the collision is not severe enough to inflate the front airbags.

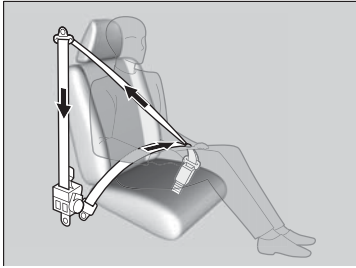

Automatic Seat Belt Tensioners

The seat belt tensioners can only operate once. If a tensioner is activated, the SRS indicator will come on. Have a dealer replace the tensioner and thoroughly inspect the seat belt system as it may not offer protection in a subsequent crash.

During a moderate-to-severe side impact, the tensioner on that side of the vehicle also activates.

امداد خودرو فارما

تلفن شبانه روزی: ۰۲۱-۸۸۸۶۲۰۸۵

FarmaSOS.com

Fastening a Seat Belt

After adjusting a front seat to the proper position, and while sitting upright and well back in the seat:

▶ **Adjusting the Seats** P. 148

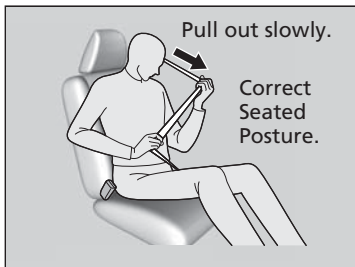

1. Pull the seat belt out slowly.

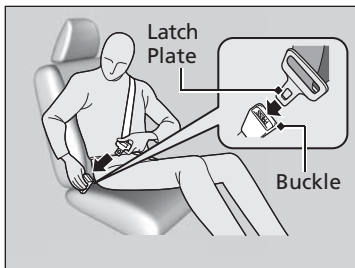

2. Insert the latch plate into the buckle, then tug on the belt to make sure the buckle is secure.

▶ Make sure that the belt is not twisted or caught on anything.

Fastening a Seat Belt

No one should sit in a seat with an inoperative seat belt or one that does not appear to be working correctly. Using a seat belt that is not working properly may not protect the occupant in a crash. Have a dealer check the belt as soon as possible.

Never insert any foreign objects into the buckle or retractor mechanism.

امداد خودرو فارما

تلفن شبانه: ۰۲۱-۸۸۱۶۲۰۸۸

FarmaSOS.com



3. Position the lap part of the belt as low as possible across your hips, then pull up on the shoulder part of the belt so the lap part fits snugly. This lets your strong pelvic bones take the force of a crash and reduces the chance of internal injuries.
4. If necessary, pull up on the belt again to remove any slack, then check that the belt rests across the center of your chest and over your shoulder. This spreads the forces of a crash over the strongest bones in your upper body.

▶ Fastening a Seat Belt

⚠ WARNING

Improperly positioning the seat belts can cause serious injury or death in a crash.

Make sure all seat belts are properly positioned before driving.

To release the belt, push the red **PRESS** button then guide the belt by hand until it has retracted completely. When exiting the vehicle, be sure the belt is out of the way and will not get caught by closing the door.

▶ Adjusting the Shoulder Anchor

The shoulder anchor height can be adjusted to four levels. If the belt contacts your neck, lower the height one level at a time.

After an adjustment, make sure that the shoulder anchor position is secure.

■ Adjusting the Shoulder Anchor

The front seats have adjustable shoulder anchors to accommodate taller and shorter occupants.

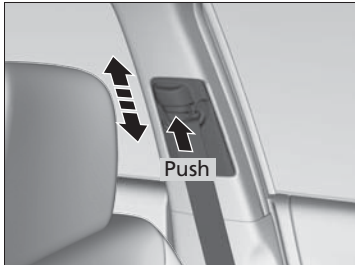

1. Move the anchor up and down while holding the release button.
2. Position the anchor so that the belt rests across the center of your chest and over your shoulder.

Advice for Pregnant Women

If you are pregnant, the best way to protect yourself and your unborn child when driving or riding in a vehicle is to always wear a seat belt and keep the lap part of the belt as low as possible across the hips.

Wear the shoulder belt across the chest avoiding the abdomen.



Wear the lap part of the belt as low as possible across the hips.

Advice for Pregnant Women

Each time you have a checkup, ask your doctor if it is okay for you to drive.

To reduce the risk of injuries to both you and your unborn child that can be caused by an inflating front airbag:

- When driving, sit upright and adjust the seat as far back as possible while allowing full control of the vehicle.
- When sitting in the front passenger's seat, adjust the seat as far back as possible.

امداد خودرو فارما

تلفن شبانه روزی: ۰۲۱-۸۸۸۶۲۰۸۵

FarmaSOS.com

Seat Belt Inspection

Regularly check the condition of your seat belts as follows:

- Pull each belt out fully, and look for frays, cuts, burns, and wear.
- Check that the latches work smoothly and the belts retract easily.
 - ▶ If a belt does not retract easily, cleaning the belt may correct the problem. Only use a mild soap and warm water. Do not use bleach or cleaning solvents. Make sure the belt is completely dry before allowing it to retract.

Any belt that is not in good condition or working properly will not provide proper protection and should be replaced as soon as possible. A belt that has been worn during a crash may not provide the same level of protection in a subsequent crash. Have your seat belts inspected by a dealer after any collision.

Seat Belt Inspection

WARNING

Not checking or maintaining seat belts can result in serious injury or death if the seat belts do not work properly when needed.

Check your seat belts regularly and have any problem corrected as soon as possible.

تلفن شبانه روزی: ۰۲۱-۸۸۸۶۲۰۸۵

FarmaSOS.com

Airbag System Components

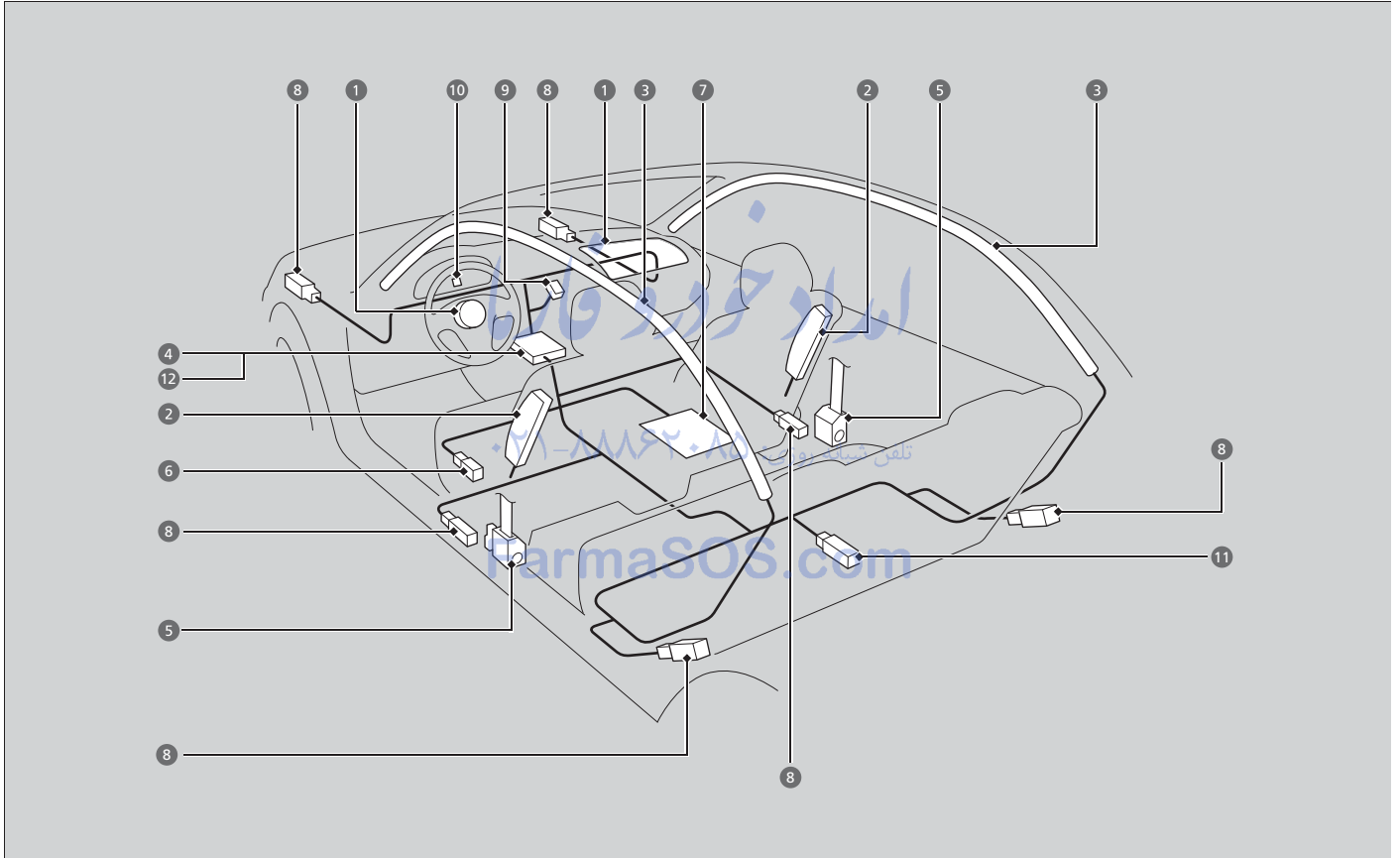

The front, front side, and side curtain airbags are deployed according to the direction and severity of impact. Both side curtain airbags are deployed in a rollover. The airbag system includes:

- 1 Two SRS (Supplemental Restraint System) front airbags. The driver's airbag is stored in the center of the steering wheel; the front passenger's airbag is stored in the dashboard. Both are marked **SRS AIRBAG**.
- 2 Two side airbags, one for the driver and one for a front passenger. The airbags are stored in the outer edges of the seat-backs. Both are marked **SIDE AIRBAG**.
- 3 Two side curtain airbags, one for each side of the vehicle. The airbags are stored in the ceiling, above the side windows. The front and rear pillars are marked **SIDE CURTAIN AIRBAG**.

4 An electronic control unit that continually monitors and can record information about the sensors, the airbag activators, the seat belt tensioners, and driver and front passenger seat belt use when the ignition switch is in ON **II***1.

5 Automatic front seat belt tensioners. The driver's and front passenger's seat belts incorporate sensors that detect whether or not they are fastened.

6 A driver's seat position sensor. If the seat is too far forward, the airbag will inflate with less force.

7 Weight sensors in the front passenger's seat. The front passenger's airbag will be turned off if the weight on the seat is 65 lbs (29 kg) or less (the weight of an infant or small child).

8 Impact sensors that can detect a moderate-to-severe front or side impact.

9 An indicator on the dashboard that alerts you that the front passenger's front airbag has been turned off.

10 An indicator on the instrument panel that alerts you to a possible problem with your airbag system or seat belt tensioners.

11 Safing Sensor

12 A rollover sensor that detects whether the vehicle is about to roll over.

*1: Models with the smart entry system have an **ENGINE START/STOP** button instead of an ignition switch.

Important Facts About Your Airbags

Airbags can pose serious hazards. To do their job, airbags must inflate with tremendous force. So, while airbags help save lives, they can cause burns, bruises, and other minor injuries, sometimes even fatal ones if occupants are not wearing their seat belts properly and sitting correctly.

What you should do: Always wear your seat belt properly, and sit upright and as far back from the steering wheel as possible while allowing full control of the vehicle. A front passenger should move their seat as far back from the dashboard as possible.

Remember, however, that no safety system can prevent all injuries or deaths that can occur in a severe crash, even when seat belts are properly worn and the airbags deploy.

Do not place hard or sharp objects between yourself and a front airbag.

Carrying hard or sharp objects on your lap, or driving with a pipe or other sharp object in your mouth, can result in injuries if your front airbag inflates.

Do not attach or place objects on the front airbag covers. Objects on the covers marked **SRS AIRBAG** could interfere with the proper operation of the airbags or be propelled inside the vehicle and hurt someone if the airbags inflate.

Important Facts About Your Airbags

Do not attempt to deactivate your airbags. Together, airbags and seat belts provide the best protection.

When driving, keep hands and arms out of the deployment path of the front airbag by holding each side of the steering wheel. Do not cross an arm over the airbag cover.

Types of Airbags

Your vehicle is equipped with three types of airbags:

- **Front airbags:** Airbags in front of the driver's and front passenger's seats.
- **Side airbags:** Airbags in the driver's and front passenger's seat-backs.
- **Side curtain airbags:** Airbags above the side windows.

Each is discussed in the following pages.

Front Airbags (SRS)

The front SRS airbags inflate in a moderate-to-severe frontal collision to help protect the head and chest of the driver and/or front passenger.

SRS (Supplemental Restraint System) indicates that the airbags are designed to supplement seat belts, not replace them. Seat belts are the occupant's primary restraint system.

Housing Locations

The front airbags are housed in the center of the steering wheel for the driver, and in the dashboard for the front passenger. Both airbags are marked **SRS AIRBAG**.

*1: Models with the smart entry system have an **ENGINE START/STOP** button instead of an ignition switch.

Types of Airbags

The airbags can inflate whenever the ignition switch is in ON *1.

After an airbag inflates in a crash, you may see a small amount of smoke. This is from the combustion process of the inflator material and is not harmful. People with respiratory problems may experience some temporary discomfort. If this occurs, get out of the vehicle as soon as it is safe to do so.

Front Airbags (SRS)

Dual-Stage, Multiple-Threshold Front Airbags (SRS)

Your vehicle is equipped with dual-stage, multiple-threshold front airbags (SRS).

During a frontal crash severe enough to cause one or both front airbags to deploy, the airbags can inflate at different rates, depending on the severity of the crash, whether or not the seat belts are latched, and/or other factors. Frontal airbags are designed to supplement the seat belts to help reduce the likelihood of head and chest injuries in frontal crashes.

■ Operation

Front airbags are designed to inflate during moderate-to-severe frontal collisions. When the vehicle decelerates suddenly, the sensors send information to the control unit which signals one or both front airbags to inflate.

A frontal collision can be either head-on or angled between two vehicles, or when a vehicle crashes into a stationary object, such as a concrete wall.

■ How the Front Airbags Work

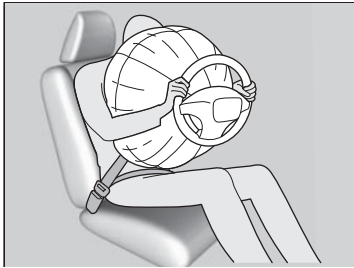

While your seat belt restrains your torso, the front airbag provides supplemental protection for your head and chest.

The front airbags deflate immediately so that they won't interfere with the driver's visibility or the ability to steer or operate other controls.

The total time for inflation and deflation is so fast that most occupants are not aware that the airbags deployed until they see them lying in front of them.

▣ How the Front Airbags Work

Although the driver's and front passenger's airbags normally inflate within a split second of each other, it is possible for only one airbag to deploy. This can happen if the severity of a collision is at the margin, or threshold, that determines whether or not the airbags will deploy. In such cases, the seat belt will provide sufficient protection, and the supplemental protection offered by the airbag would be minimal.

FarmaSOS.com

■ When front airbags should not deploy

Minor frontal crashes: Front airbags were designed to supplement seat belts and help save lives, not to prevent minor scrapes, or even broken bones that might occur during a less than moderate-to-severe frontal crash.

Side impacts: Front airbags can provide protection when a sudden deceleration causes a driver or front passenger to move towards the front of the vehicle. Side airbags and side curtain airbags have been specifically designed to help reduce the severity of injuries that can occur during a moderate-to-severe side impact which can cause the driver or passenger to move towards the side of the vehicle.

Rear impacts: Head restraints and seat belts are your best protection during a rear impact. Front airbags cannot provide any significant protection and are not designed to deploy in such collisions.

Rollovers: Seat belts and, in vehicles equipped with a rollover sensor, side airbags and side curtain airbags offer the best protection in a rollover. Because front airbags could provide little if any protection, they are not designed to deploy during a rollover.

■ When front airbags deploy with little or no visible damage

Because the airbag system senses sudden deceleration, a strong impact to the vehicle framework or suspension might cause one or more of the airbags to deploy. Examples include running into a curb, the edge of a hole, or other low fixed object that causes a sudden deceleration in the vehicle chassis. Since the impact is underneath the vehicle, damage may not be readily apparent.

■ When front airbags may not deploy, even though exterior damage appears severe

Since crushable body parts absorb crash energy during an impact, the amount of visible damage does not always indicate proper airbag operation. In fact, some collisions can result in severe damage but no airbag deployment because the airbags would not have been needed or would not have provided protection even if they had deployed.

Advanced Airbags

Your front airbags have advanced features to help reduce the likelihood of airbag related injuries to smaller occupants.

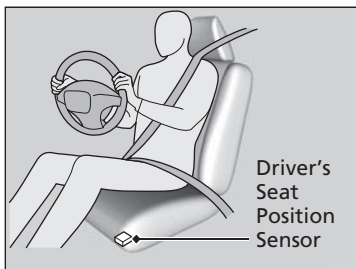

The driver's advanced front airbag system includes a seat position sensor.

If the seat is too far forward, the airbag inflates with less force, regardless of the severity of the impact.

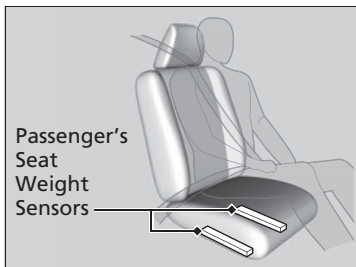

The passenger's advanced front airbag system has weight sensors.

Although we recommend against carrying an infant or small child in front, if the sensors detect the weight of a child (up to about 65 lbs or 29 kg), the system will automatically turn off the passenger's front airbag.

Advanced Airbags

If there is a problem with the driver's seat position sensor, the SRS indicator will come on and the airbag will inflate with full (normal) force, regardless of the driver's seating position.

For both advanced front airbags to work properly:

- Do not spill any liquid on or under the seats.
- Do not put any object under the passenger's seat.
- Make sure any objects are positioned properly on the floor. Improperly positioned objects can interfere with the advanced airbag sensors.
- All occupants should sit upright and wear their seat belts properly.
- Do not place any cover over the passenger side dashboard.

امداد خودرو فارما

تلفن شبانه روزی: ۰۲۱-۸۸۶۲۰۸۵

FarmaSUS.com

Side Airbags

The side airbags help protect the torso and pelvis of the driver or a front passenger during a moderate-to-severe side impact.

Housing Locations



The side airbags are housed in the outside edge of the driver's and passenger's seat-backs.

Both are marked **SIDE AIRBAG**.

Operation

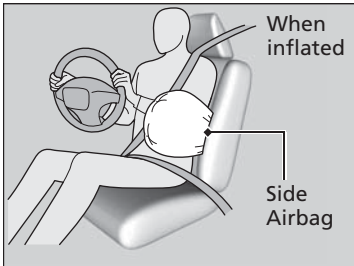

When the sensors detect a moderate-to-severe side impact, the control unit signals the side airbag on the impact side to immediately inflate.

Side Airbags

Make sure you and your front seat passenger always sit upright. Leaning into the path of a side airbag can prevent the airbag from deploying properly and increases your risk of serious injury.

Do not attach accessories on or near the side airbags. They can interfere with the proper operation of the airbags, or hurt someone if an airbag inflates.

If the impact is on the passenger side, the airbag deploys even if there is no passenger in the passenger seat.

Do not cover or replace the front seat-back covers without consulting a dealer.

Improperly replacing or covering front seat-back covers can prevent your side airbags from properly deploying during a side impact.

■ When a side airbag deploys with little or no visible damage

Because the airbag systems senses sudden acceleration, a strong impact to the side of the vehicle's framework can cause a side airbag to deploy. In such cases, there may be little or no damage, but the side impact sensors detected a severe enough impact to deploy the airbag.

■ When a side airbag may not deploy, even though visible damage appears severe

It is possible for a side airbag to not deploy during an impact that results in apparently severe damage. This can occur when the point of impact was towards the far front or rear of the vehicle, or when the vehicle's crushable body parts absorbed most of the crash energy. In either case, the side airbag would not have been needed nor provided protection even if it had deployed.

تلفن شبانه روزی: ۰۲۱-۸۸۸۶۲۰۸۵

FarmaSOS.com

Side Curtain Airbags

The side curtain airbags help protect the heads of the driver and passengers in outer seating positions during a moderate-to-severe side impact. The side curtain airbags equipped in this vehicle are also designed to help reduce the likelihood of partial and complete ejection of vehicle occupants through side windows in crashes, particularly rollover crashes.

Housing Locations

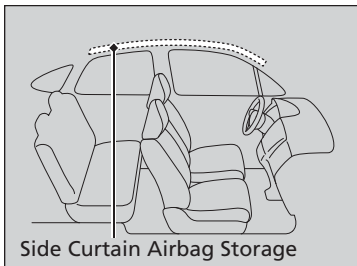

Side Curtain Airbag Storage

The side curtain airbags are located in the ceiling above the side windows on both sides of the vehicle.

Operation

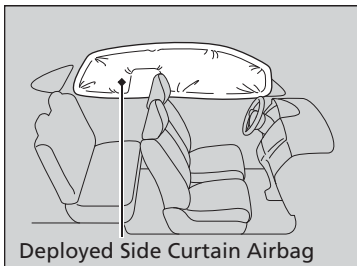

Deployed Side Curtain Airbag

The side curtain airbag is designed to deploy in a rollover or a moderate-to-severe side impact.

Side Curtain Airbags

If the SRS control unit senses that your vehicle is about to rollover, it immediately deploys both side curtain airbags and activates both front seat belt tensioners.

If the impact is on the passenger's side, the passenger's side curtain airbag will inflate even if there are no occupants on that side of the vehicle.

To get the best protection from the side curtain airbags, occupants should wear their seat belts properly and sit upright and well back in their seats.

Do not attach any objects to the side windows or roof pillars as they can interfere with the proper operation of the side curtain airbags.

تلفن شبانه روزی: ۰۲۱-۸۸۸۶۲۰۸۵

FarmaSOS.com

■ When side curtain airbags deploy in a frontal collision

One or both side curtain airbags may inflate in a moderate-to-severe angled frontal collision.

In this case, the side curtain airbags will deploy slightly after the front airbags.

Airbag System Indicators

If a problem occurs in the airbag system, the SRS indicator will come on and a message appears on the multi-information display*.

■ Supplemental Restraint System (SRS) Indicator

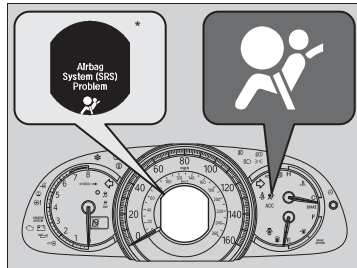

■ When the ignition switch is turned to ON *1

The indicator comes on for a few seconds, then goes off. This tells you the system is working properly.

Supplemental Restraint System (SRS) Indicator

⚠ WARNING

Ignoring the SRS indicator can result in serious injury or death if the airbag systems or tensioners do not work properly.

Have your vehicle checked by a dealer as soon as possible if the SRS indicator alerts you to a possible problem.

If the indicator comes on at any other time, or does not come on at all, have the system checked by a dealer as soon as possible. If you don't, your airbags and seat belt tensioners may not work properly when they are needed.

*1: Models with the smart entry system have an **ENGINE START/STOP** button instead of an ignition switch.

* Not available on all models

Continued

Passenger Airbag Off Indicator

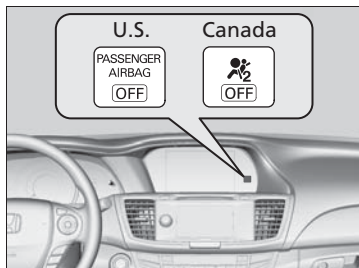

■ When the passenger airbag off indicator comes on

The indicator comes on to alert you that the passenger's front airbag has been turned off. This occurs when the front passenger's weight sensors detect 65 lbs (29 kg) or less, the weight of an infant or small child, on the seat.

Infants and small children should always ride properly restrained in a back seat.

➤ **Child Safety** P. 52

Objects placed on the seat can also cause the indicator to come on.

If the front passenger seat is empty, the passenger's front airbag will not deploy and the indicator will not come on.

Passenger Airbag Off Indicator

If the indicator comes on with no front passenger and no objects on the passenger's seat, or with an adult riding there, something may be interfering with the weight sensors, such as:

- An object hanging on the seat or in the seat-back pocket.
- A child seat or other object pressing against the rear of the seat-back.
- A rear passenger pushing or pulling on the back of the front passenger's seat.
- The front seat or seat-back is forced back against an object on the seat or floor behind it.
- An object placed under the front passenger's seat.

If none of these conditions exist, have your vehicle checked by a dealer as soon as possible.

The passenger airbag off indicator may come on and go off repeatedly if the total weight on the seat is near the airbag cutoff threshold.

Airbag Care

You do not need to, and should not, perform any maintenance on or replace any airbag system components yourself. However, you should have your vehicle inspected by a dealer in the following situations:

■ When the airbags have deployed

If an airbag has inflated, the control unit and other related parts must be replaced. Similarly, once an automatic seat belt tensioner has been activated, it must be replaced.

■ When the vehicle has been in a moderate-to-severe collision

Even if the airbags did not inflate, have your dealer inspect the following: the driver's seat position sensor, weight sensors in the passenger's seat, front seat belt tensioners, and each seat belt that was worn during the crash.

■ Do not remove or modify a front seat without consulting a dealer

This would likely disable the driver's seat position sensor or the weight sensors in the passenger's seat. If it is necessary to remove or modify a front seat to accommodate a person with disabilities, contact a Honda dealer, or for U.S. vehicles, American Honda Automobile Customer Service at 800-999-1009 and for Canadian vehicles, Honda Canada Customer Relations at 888-9-HONDA-9.

▣ Airbag Care

We recommend against the use of salvaged airbag system components, including the airbag, tensioners, sensors, and control unit.

Protecting Child Passengers

Each year, many children are injured or killed in vehicle crashes because they are either unrestrained or not properly restrained. In fact, vehicle accidents are the number one cause of death of children ages 12 and under.

To reduce the number of child deaths and injuries, every state, Canadian province and territory requires that infants and children be properly restrained when they ride in a vehicle.

Children should sit properly restrained in a rear seat. This is because:

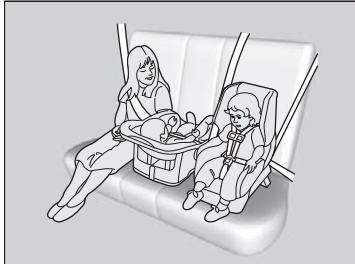

- An inflating front or side airbag can injure or kill a child sitting in the front seat.
- A child in the front seat is more likely to interfere with the driver's ability to safely control the vehicle.
- Statistics show that children of all sizes and ages are safer when they are properly restrained in a rear seat.

Protecting Child Passengers

⚠ WARNING

Children who are unrestrained or improperly restrained can be seriously injured or killed in a crash.

Any child too small for a seat belt should be properly restrained in a child seat. A larger child should be properly restrained with a seat belt, using a booster seat if necessary.

The National Highway Traffic Safety Administration and Transport Canada recommend that all children ages 12 and under be properly restrained in a rear seat. Some states or provinces/territories have laws restricting where children may ride.

- Any child who is too small to wear a seat belt correctly must be restrained in an approved child seat that is properly secured to the vehicle using either the lap belt portion of the lap/shoulder belt or the lower anchors of the LATCH system.
- Never hold a child on your lap because it is impossible to protect them in the event of a collision.
- Never put a seat belt over yourself and a child. During a crash, the belt would likely press deep into the child and cause serious or fatal injuries.
- Never let two children use the same seat belt. Both children could be very seriously injured in a crash.
- Do not allow children to operate the doors, windows or seat adjustments.
- Do not leave children in the vehicle unattended, especially in hot weather when the inside of the vehicle can get hot enough to kill them. They could also activate vehicle controls causing it to move unexpectedly.

▶▶ Protecting Child Passengers

⚠ WARNING

Allowing a child to play with a seat belt or wrap one around their neck can result in serious injury or death.

Instruct children not to play with any seat belt and make sure any unused seat belt a child can reach is buckled, fully retracted, and locked.

To deactivate a lockable retractor, release the buckle and allow the seat belt to wind up all the way.

To remind you of the passenger's front airbag hazards and child safety, your vehicle has warning labels on the dashboard (U.S. models) and on the front visors. Please read and follow the instructions on these labels.

▶▶ **Safety Labels** P. 65

Safety of Infants and Small Children

Protecting Infants

An infant must be properly restrained in a rear-facing, reclining child seat until the infant reaches the seat maker's weight or height limit for the seat, and the infant is at least one year old.

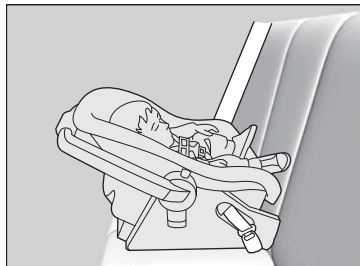

Positioning a rear-facing child seat

Child seats must be placed and secured in a rear seating position.

When properly installed, a rear-facing child seat may prevent the driver or a front passenger from moving their seat all the way back, or from locking their seat-back in the desired position.

It can also interfere with proper operation of the passenger's advanced front airbag system.

► **Airbags** P. 39

If this occurs, we recommend that you install the child seat directly behind the front passenger's seat, move the seat as far forward as needed, and leave it unoccupied. Or, you may wish to get a smaller rear-facing child seat.

Protecting Infants

WARNING

Placing a rear-facing child seat in the front seat can result in serious injury or death during a crash.

Always place a rear-facing child seat in the rear seat, not the front.

Rear-facing child seats should never be installed in a forward facing position.

Always refer to the child seat manufacturer's instructions before installation.

■ Protecting Smaller Children

If a child is at least one year old and within the weight range indicated by the child seat manufacturer, the child should be properly restrained in a firmly secured forward-facing child seat.

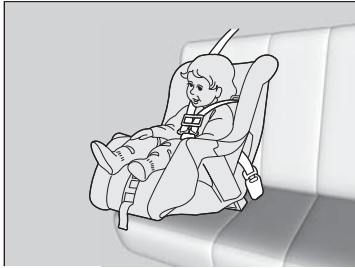

■ Forward-facing child seat placement

We strongly recommend placing a forward-facing child seat in a rear seating position.

Placing a forward-facing child seat in the front seat can be hazardous, even with advanced front airbags that automatically turn the passenger's front airbag off. A rear seat is the safest place for a child.

▶▶ Protecting Smaller Children

⚠ WARNING

Placing a forward-facing child seat in the front seat can result in serious injury or death if the front airbag inflates.

If you must place a forward-facing child seat in front, move the vehicle seat as far back as possible, and properly restrain the child.

Educate yourself about the laws and regulations regarding child seat use where you are driving, and follow the child seat manufacturer's instructions.

Many experts recommend use of a rear-facing seat for a child up to two years old if the child's height and weight are appropriate for a rear-facing seat.

FarmaSOS.com

■ Selecting a Child Seat

Most child seats are LATCH-compatible (Lower Anchors and Tethers for Children). Some have a rigid-type connector, while others have a flexible-type connector. Both are equally easy to use. Some existing and previously owned child seats can only be installed using the seat belt. Whichever type you choose, follow the child seat manufacturer's use and care instructions as well as the instructions in this manual. Proper installation is key to maximizing your child's safety.

In seating positions and vehicles not equipped with LATCH, a LATCH compatible child seat can be installed using the seat belt and a top tether for added security. This is because all child seats are required to be designed so that they can be secured with a lap belt or the lap part of a lap/shoulder belt. In addition, the child seat manufacturer may advise that a seat belt be used to attach a LATCH-compatible seat once a child reaches a specified weight. Please read the child seat owner's manual for proper installation instructions.

■ Important consideration when selecting a child seat

Make sure the child seat meets the following three requirements:

- The child seat is the correct type and size for the child.
- The child seat is the correct type for the seating position.
- The child seat is compliant with Federal Motor Vehicle Safety Standard 213 or Canadian Motor Vehicle Safety Standard 213.

► Selecting a Child Seat

Installation of a LATCH-compatible child seat is simple.

LATCH-compatible child seats have been developed to simplify the installation process and reduce the likelihood of injuries caused by incorrect installation.

■ Installing a LATCH-Compatible Child Seat

A LATCH-compatible child seat can be installed in either of the two outer rear seats. A child seat is attached to the lower anchors with either the rigid or flexible type of connectors.

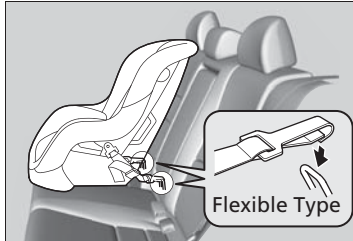
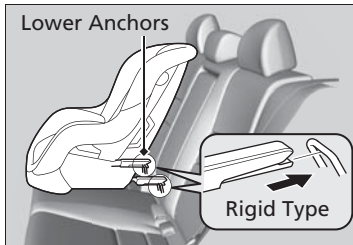
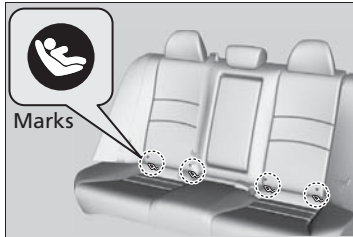

1. Locate the lower anchors under the marks.

2. Place the child seat on the vehicle seat then attach the child seat to the lower anchors according to the instructions that came with the child seat.

- ▶ When installing the child seat, make sure that the lower anchors are not obstructed by the seat belt or any other object.

امداد خودرو فارما

تلفن شبانه ۰۲۱-۸۸۸۸۸۸۸۸
FarmaSOS.com

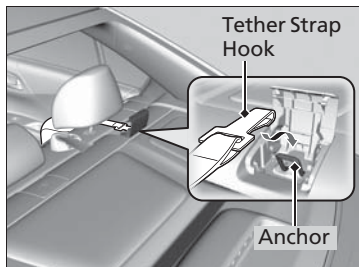

3. Open the tether anchor cover behind the head restraint.
4. Raise the head restraint to its highest position, then route the tether strap between the head restraint legs, and secure the tether strap hook onto the anchor.
5. Tighten the tether strap as instructed by the child seat manufacturer.
6. Make sure the child seat is firmly secured by rocking it forward and back and side to side; little movement should be felt.
7. Make sure any unused seat belt that a child can reach is buckled, the lockable retractor is activated, and the belt is fully retracted and locked.

تلفن شبانه روزی: ۰۲۱-۸۸۸۶۲۰۸۵

FarmaSOS.com

▶▶ Installing a LATCH-Compatible Child Seat

For your child's safety, when using a child seat installed using the LATCH system, make sure that the seat is properly secured to the vehicle. A child seat that is not properly secured will not adequately protect a child in a crash and may cause injury to the child or other vehicle occupants.

■ Installing a Child Seat with a Lap/Shoulder Seat Belt



1. Place the child seat on the vehicle seat.
2. Route the seat belt through the child seat according to the seat manufacturer's instructions, and insert the latch plate into the buckle.
 - ▶ Insert the latch plate fully until it clicks.

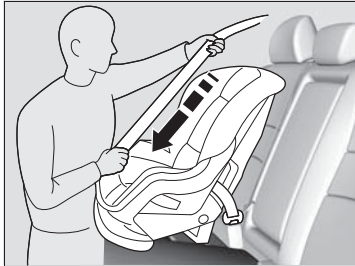

3. Slowly pull the shoulder part of the belt all the way out until it stops. This activates the lockable retractor.
4. Let the seat belt completely wind up into the retractor, then try to pull it out to make sure the retractor is locked.
 - ▶ If you are able to pull the shoulder belt out, the lockable retractor is not activated. Pull the seat belt all the way out, and repeat steps 2 – 4.



5. Grab the shoulder part of the seat belt near the buckle, and pull up to remove any slack from the lap part of the belt.
 - ▶ When doing this, place your weight on the child seat and push it into the vehicle seat.

■ Installing a Child Seat with a Lap/Shoulder Seat Belt

A child seat that is not properly secured will not adequately protect a child in a crash and may cause injury to the child or other vehicle occupants.

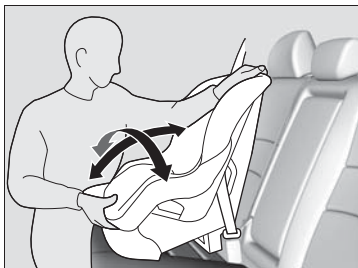

6. Make sure the child seat is firmly secured by rocking it forward and back and side to side; little movement should be felt.
7. Make sure any unused seat belt that a child can reach is buckled, the lockable retractor is activated, and the belt is fully retracted and locked.

►► Installing a Child Seat with a Lap/Shoulder Seat Belt

To deactivate a lockable retractor, release the buckle and allow the seat belt to wind up all the way.

امداد خودرو فارما

تلفن شبانه روزی: ۰۲۱-۸۸۸۶۲۰۸۵

FarmaSOS.com

Adding Security with a Tether

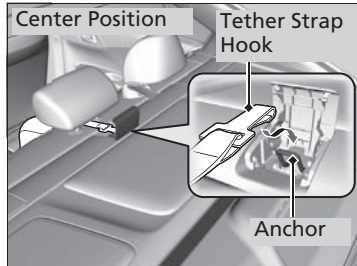
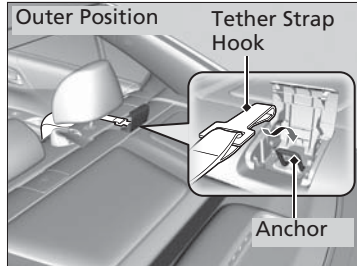
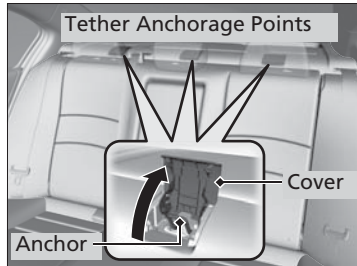

A tether anchorage point is provided behind each rear seating position. A child seat that is installed with a seat belt and comes with a tether can use the tether for additional security.

1. Locate the appropriate tether anchorage point and lift the cover.
2. Raise the head restraint to its highest position, then route the tether strap through the head restraint legs. Make sure the strap is not twisted.
3. Secure the tether strap hook onto the anchor.
4. Tighten the tether strap as instructed by the child seat manufacturer.

Adding Security with a Tether

Since a tether can provide additional security to the lap/shoulder seat belt installation, we recommend using a tether whenever one is available.

امداد خودرو فارما

تلفن شبانه روزی: ۰۲۱-۸۸۸۶۲۰۸۵

FarmaSOS.com

Safety of Larger Children

Protecting Larger Children

The following pages give instructions on how to check proper seat belt fit, what kind of booster seat to use if one is needed, and important precautions for a child who must sit in front.

Checking Seat Belt Fit

When a child is too big for a child seat, secure the child in a rear seat using the lap/shoulder seat belt. Have the child sit upright and all the way back, then answer the following questions.

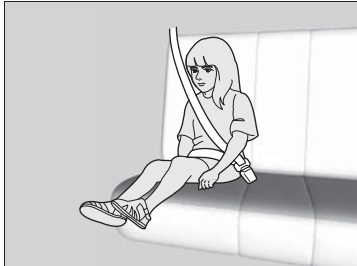

Checklist

- Do the child's knees bend comfortably over the edge of the seat?
- Does the shoulder belt cross between the child's neck and arm?
- Is the lap part of the seat belt as low as possible, touching the child's thighs?
- Will the child be able to stay seated like this for the whole trip?

If you answer yes to all these questions, the child is ready to wear the lap/shoulder seat belt correctly. If you answer no to any question, the child needs to ride on a booster seat until the seat belt fits properly without a booster seat.

► Safety of Larger Children

⚠ WARNING

Allowing a child age 12 or under to sit in front can result in injury or death if the passenger's front airbag inflates.

If a larger child must ride in front, move the vehicle seat as far to the rear as possible, have the child sit up properly and wear the seat belt properly, using a booster seat if needed.

Booster Seats



If a lap/shoulder seat belt cannot be used properly, position the child in a booster seat in a rear seating position. For the child's safety, check that the child meets the booster seat manufacturer's recommendations.

Protecting Larger Children-Final Checks

Your vehicle has a rear seat where children can be properly restrained. If you ever have to carry a group of children, and a child must ride in front:

- Make sure you read and fully understand the instructions and safety information in this manual.
- Move the front passenger seat as far back as possible.
- Have the child sit upright and well back in the seat.
- Check that the seat belt is properly positioned so that the child is secure in the seat.

Monitoring child passengers

We strongly recommend that you keep an eye on child passengers. Even older, more mature children sometimes need to be reminded to fasten their seat belts and sit up properly.

Booster Seats

When installing a booster seat, make sure to read the instructions that came with it, and install the seat accordingly.

There are high- and low-type booster seats. Choose a booster seat that allows the child to wear the seat belt correctly.

Some U.S. states and Canadian provinces and territories require children to use a booster seat until they reach a given age or weight (e.g. 6 years or 60 lbs). Be sure to check current laws in the state or province, or territory where you intend to drive.

Carbon Monoxide Gas

The engine exhaust from this vehicle contains carbon monoxide, a colorless, odorless, and highly toxic gas. As long as you properly maintain your vehicle, carbon monoxide gas will not get into the interior.

■ Have the exhaust system inspected for leaks whenever

- The exhaust system is making an unusual noise.
- The exhaust system may have been damaged.
- The vehicle is raised for an oil change.

When you operate a vehicle with the trunk open, airflow can pull exhaust gas into the interior and create a hazardous condition. If you must drive with the trunk open, open all the windows and set the heating and cooling system*/climate control system* as shown below.

1. Select the fresh air mode.
2. Select the  mode.
3. Set the fan speed to high.
4. Set the temperature control to a comfortable setting.

Adjust the heating and cooling system*/climate control system* in the same manner if you sit in your parked vehicle with the engine running.

Carbon Monoxide Gas

⚠ WARNING

Carbon monoxide gas is toxic. Breathing it can cause unconsciousness and even kill you.

Avoid any enclosed areas or activities that expose you to carbon monoxide.

An enclosed area such as a garage can quickly fill up with carbon monoxide gas. Do not run the engine with the garage door closed. Even when the garage door is open, drive out of the garage immediately after starting the engine.

Label Locations

These labels are in the locations shown. They warn you of potential hazards that can cause serious injury or death. Read these labels carefully.

If a label comes off or becomes hard to read (except for the U.S. dashboard label which may be removed by the owner), contact a dealer for a replacement.

Sun Visor

U.S. models

▲ WARNING

EVEN WITH ADVANCED AIR BAGS

Children can be killed or seriously injured by the air bag.

- The back seat is the safest place for children.
- Never put a rear-facing child seat in the front.
- Always use seat belt in one child restraint.
- See owner's manual for more information about air bags.

Canadian models

CAUTION

TO AVOID SERIOUS INJURY:

- FOR MAXIMUM SAFETY PROTECTION IN ALL TYPES OF CRASHES, YOU MUST ALWAYS WEAR YOUR SAFETY BELT.
- DO NOT INSTALL REARWARD-FACING CHILD SEATS IN ANY FRONT PASSENGER SEAT POSITION.
- DO NOT SIT OR LEAN UNNECESSARILY CLOSE TO THE AIR BAG.
- DO NOT PLACE ANY OBJECTS OVER THE AIR BAG OR BETWEEN THE AIR BAG AND YOURSELF.
- SEE THE OWNER'S MANUAL FOR FURTHER INFORMATION AND EXPLANATIONS.

PRECAUTIONS:

POUR EVITER DES BLESSURES GRAVES:

- POUR PROFITER D'UNE PROTECTION MAXIMALE LORS D'UNE COLLISION BOUCLEZ TOUJOURS VOTRE CEINTURE DE SECURITE.
- N'INSTALLEZ JAMAIS UN SIEGE POUR ENFANTS FAISANT FACE A L'ARRIERE SUR LE SIEGE DU PASSAGER AVANT.
- NE VOUS APPUYEZ PAS ET NE VOUS ASSOYEZ PAS PRES DU COUSSIN GONFLABLE.
- NE DEPOSEZ AUCUN OBJET SUR LE COUSSIN GONFLABLE OU ENTRE LE COUSSIN GONFLABLE ET VOUS.
- LISEZ LE GUIDE UTILISATEUR POUR DE PLUS AMPLES RENSEIGNEMENTS.

Dashboard

U.S. models only

This Vehicle is Equipped with Advanced Air Bags

Even with Advanced Air Bags

Children can be killed or seriously injured by the air bags. The back seat is the safest place for children. Never put a rear-facing child seat in the front. Always use seat belts and child restraints. See owner's manual for more information about air bags. (To be removed by owner.)

Doorjamb

U.S. models

SIDE AIRBAG

- This car is equipped with side airbags in the front seats and side curtain airbags.
- Do not lean against the door.
- See owner's manual for more information.

Canadian models

SIDE AIRBAG

- Cette voiture est équipée de coussins gonflables latéraux dans les sièges avant ainsi que de coussins gonflables latéraux de type rideau.
- Ne vous appuyez pas sur la porte.
- Consultez le Manuel du propriétaire pour en savoir plus.

Radiator Cap

DANGER
WARNING

NEVER OPEN WHEN HOT.
Hot coolant will scald you.
NEVER OUVRIER PAS QUAND CHAUDE.
NEUT JAMAIS OUVRIER LE CAPOT DU MOTEUR QUAND CHAUD.
NEVER OPEN WHEN HOT.
Hot coolant will scald you.
NEVER OUVRIER PAS QUAND CHAUDE.
NEUT JAMAIS OUVRIER LE CAPOT DU MOTEUR QUAND CHAUD.

1.1

امداد خودرو فارما

تلفن شبانه روزی: ۰۲۱-۸۸۸۶۲۰۸۵

FarmaSOS.com

Instrument Panel

This chapter describes the buttons, indicators, and gauges that are used while driving.









امداد خودرو فارما

تلفن شبانه روزی ۰۸۵-۸۸۸۶۲۰۲۱







FarmaSOS.com

Indicators	68
Information Display Warning and Information Messages*	82
Multi-Information Display Warning and Information Messages*	84
Gauges and Displays	
Gauges	89
Information Display*	90
Multi-Information Display*	93

* Not available on all models



Indicator	Name	On/Blinking	Explanation	Message*
 <p>U.S. BRAKE</p>  <p>Canada BRAKE</p> <p>(Red)</p>	Parking Brake and Brake System Indicator (Red)	<ul style="list-style-type: none"> Comes on for a few seconds when you turn the ignition switch to ON II*¹, then goes off if the parking brake has been released. Comes on when the parking brake is applied, and goes off when it is released. Comes on when the brake fluid level is low. Comes on if there is a problem with the brake system. The beeper sounds and the indicator comes on if you drive with the parking brake not fully released. 	<ul style="list-style-type: none"> Comes on while driving - Make sure the parking brake is released. Check the brake fluid level. <ul style="list-style-type: none"> ➤ What to do when the indicator comes on while driving P. 560 Comes on along with the ABS indicator - Have your vehicle checked by a dealer. <ul style="list-style-type: none"> ➤ If the Brake System Indicator (Red) Comes On P. 560 	  
 <p>U.S. BRAKE SYSTEM</p>  <p>Canada BRAKE SYSTEM</p> <p>(Amber)</p>	Brake System Indicator (Amber)	<ul style="list-style-type: none"> Comes on for a few seconds when you turn the ignition switch to ON II*¹, then goes off. Comes on if there is a problem with a component related to braking. 	<ul style="list-style-type: none"> Stays on constantly - Have your vehicle checked by a dealer. 	

*1: Models with the smart entry system have an **ENGINE START/STOP** button instead of an ignition switch.

Indicator	Name	On/Blinking	Explanation	Message*
	Low Oil Pressure Indicator	<ul style="list-style-type: none"> Comes on when you turn the ignition switch to ON [II]*1, and goes off when the engine starts. Comes on when the engine oil pressure is low. 	<ul style="list-style-type: none"> Comes on while driving - Immediately stop in a safe place. <ul style="list-style-type: none"> ► If the Low Oil Pressure Indicator Comes On P. 558 	
	Malfunction Indicator Lamp	<ul style="list-style-type: none"> Comes on when you turn the ignition switch to ON [II]*1, and goes off either when the engine starts or after several seconds if the engine did not start. If “readiness codes” have not been set, it blinks five times before it goes off. Comes on if there is a problem with the emissions control system. Blinks when a misfire in the engine's cylinders is detected. 	<ul style="list-style-type: none"> Readiness codes are part of the on board diagnostics for the emissions control systems. <ul style="list-style-type: none"> ► Testing of Readiness Codes P. 575 Comes on while driving - Have your vehicle checked by a dealer. Blinks while driving - Stop in a safe place where there are no flammable objects. Stop the engine for 10 minutes or more, and wait for it to cool down. Then, take the vehicle to a dealer. <ul style="list-style-type: none"> ► If the Malfunction Indicator Lamp Comes On or Blinks P. 559 	
	Charging System Indicator	<ul style="list-style-type: none"> Comes on when you turn the ignition switch to ON [II]*1, and goes off when the engine starts. Comes on when the battery is not charging. 	<ul style="list-style-type: none"> Comes on while driving - Turn off the heating and cooling system*/climate control system* and rear defogger in order to reduce electricity consumption. <ul style="list-style-type: none"> ► If the Charging System Indicator Comes On P. 558 	

*1: Models with the smart entry system have an **ENGINE START/STOP** button instead of an ignition switch.

* Not available on all models











Indicator	Name	On/Blinking	Explanation	Message*
<div style="border: 1px solid black; padding: 2px; font-size: 8px;">Models with information display</div>  <div style="border: 1px solid black; padding: 2px; font-size: 8px;">Models with multi-information display</div> 	Shift Lever Position Indicator*	<ul style="list-style-type: none"> Indicates the current shift lever position. 	<p>➤ Shifting P. 433, 435, 439</p>	—
	M (7-speed manual shift mode) Indicator/Shift Indicator*	<ul style="list-style-type: none"> Comes on when 7-speed manual shift mode is applied. 	<p>➤ 7-Speed Manual Shift Mode P. 437</p>	—

Indicator	Name	On/Blinking	Explanation	Message *
<p>Models with information display</p>  <p>Models with multi-information display</p> 	<p>Transmission Indicator*</p>	<ul style="list-style-type: none"> Blinks if the transmission system has a problem. 	<ul style="list-style-type: none"> Blinks while driving - Avoid sudden starts and acceleration and have your vehicle checked by a dealer immediately. 	
	<p>Seat Belt Reminder Indicator</p>	<ul style="list-style-type: none"> Comes on and the beeper sounds if you are not wearing a seat belt when you turn the ignition switch to ON *1. If the front passenger is not wearing a seat belt, the indicator comes on a few seconds later. Blinks while driving if either you or the front passenger has not fastened a seat belt. The beeper sounds and the indicator blinks at regular intervals. 	<ul style="list-style-type: none"> The beeper stops and the indicator goes off when you and the front passenger fasten their seat belts. Stays on after you or the front passenger has fastened the seat belt - A detection error may have occurred in the sensor. Have your vehicle checked by a dealer. <p> Seat Belt Reminder P. 33</p>	 





Instrument Panel

*1: Models with the smart entry system have an **ENGINE START/STOP** button instead of an ignition switch.

* Not available on all models

Indicator	Name	On/Blinking	Explanation	Message*
	Low Fuel Indicator	<ul style="list-style-type: none"> Comes on when the fuel reserve is running low (approximately 2.6 U.S. gal./9.7 Liter left). Blinks if there is a problem with the fuel gauge. 	<ul style="list-style-type: none"> Comes on - Refuel your vehicle as soon as possible. Blinks - Have your vehicle checked by a dealer. 	 
	Anti-lock Brake System (ABS) Indicator	<ul style="list-style-type: none"> Comes on for a few seconds when you turn the ignition switch to ON ^{*1}, then goes off. If it comes on at any other time, there is a problem with the ABS. 	<ul style="list-style-type: none"> Stays on constantly - Have your vehicle checked by a dealer. With this indicator on, your vehicle still has normal braking ability but no anti-lock function. <p> Anti-lock Brake System (ABS) P. 474</p>	
	Supplemental Restraint System Indicator	<ul style="list-style-type: none"> Comes on for a few seconds when you turn the ignition switch to ON ^{*1}, then goes off. Comes on if a problem with any of the following is detected: <ul style="list-style-type: none"> - Supplemental restraint system - Side airbag system - Side curtain airbag system - Seat belt tensioner 	<ul style="list-style-type: none"> Stays on constantly or does not come on at all - Have your vehicle checked by a dealer. 	







*1: Models with the smart entry system have an **ENGINE START/STOP** button instead of an ignition switch.

Indicator	Name	On/Blinking	Explanation	Message*
	Vehicle Stability Assist (VSA®) System Indicator	<ul style="list-style-type: none"> Comes on for a few seconds when you turn the ignition switch to ON II*1, then goes off. Blinks when VSA® is active. Comes on if there is a problem with the VSA® system or hill start assist system. 	<ul style="list-style-type: none"> Stays on constantly - Have your vehicle checked by a dealer. <ul style="list-style-type: none"> ➤ Vehicle Stability Assist (VSA®), aka Electronic Stability Control (ESC), System P. 464 	
	Vehicle Stability Assist (VSA®) OFF Indicator	<ul style="list-style-type: none"> Comes on for a few seconds when you turn the ignition switch to ON II*1, then goes off. Comes on when you deactivate VSA®. 	<ul style="list-style-type: none"> ➤ VSA® On and Off P. 465 	





Instrument Panel

*1: Models with the smart entry system have an **ENGINE START/STOP** button instead of an ignition switch.

FarmaSOS.com









Indicator	Name	On/Blinking	Explanation	Message*
<p>Models with information display</p>  <p>Models with multi-information display</p> 	Door and Trunk Open Indicator	<ul style="list-style-type: none"> Comes on for a few seconds if you turn the ignition switch to ON *1, then goes off. Comes on if any door or the trunk is not completely closed. The beeper sounds and the indicator comes on if any door or the trunk is opened while driving. 	<ul style="list-style-type: none"> Goes off when all doors and the trunk are closed. 	
	Electric Power Steering (EPS) System Indicator	<ul style="list-style-type: none"> Comes on when you turn the ignition switch to ON *1, and goes off when the engine starts. Comes on if there is a problem with the EPS system. 	<ul style="list-style-type: none"> Stays on constantly or does not come on at all - Have your vehicle checked by a dealer. ➤ If the Electric Power Steering (EPS) System Indicator Comes On P. 560 	

*1: Models with the smart entry system have an **ENGINE START/STOP** button instead of an ignition switch.



Indicator	Name	On/Blinking	Explanation	Message*
	Low Tire Pressure/TPMS Indicator	<ul style="list-style-type: none"> • Comes on for a few seconds when you turn the ignition switch to ON *1, then goes off. • May come on briefly if the ignition switch is turned to ON *1 and the vehicle is not moved within 45 seconds, to indicate the calibration process is not yet complete. • Comes on and stays on when: <ul style="list-style-type: none"> - One or more tires' pressures are determined to be significantly low. - The system has not been calibrated. 	<ul style="list-style-type: none"> • Comes on while driving - Stop in a safe place, check tire pressures, and inflate the tire(s) if necessary. • Stays on after the tires are inflated to the recommended pressures - The system needs to be calibrated. <ul style="list-style-type: none"> ➤ TPMS Calibration P. 468 	
		<ul style="list-style-type: none"> • Blinks for about one minute, and then stays on if there is a problem with the TPMS, or when a compact spare tire is temporarily installed. 	<ul style="list-style-type: none"> • Blinks and remains on - Have your vehicle checked by a dealer. If the vehicle is fitted with a compact spare, get your regular tire repaired or replaced and put back on your vehicle as soon as you can. 	

Instrument Panel

* 1: Models with the smart entry system have an **ENGINE START/STOP** button instead of an ignition switch.





Indicator	Name	On/Blinking	Explanation	Message*
	System Message Indicator*	<ul style="list-style-type: none"> Comes on for a few seconds when you turn the ignition switch to ON ^{*1}, then goes off. Comes on along with a beep when a problem is detected. A system message on the multi-information display appears at the same time. 	<ul style="list-style-type: none"> While the indicator is on, press the  (information) button to see the message again. Refer to the Indicators information in this chapter when a system message appears on the multi-information display. Take the appropriate action for the message. The multi-information display does not return to the normal screen unless the warning is canceled, or the  button is pressed. 	—
	Turn Signal and Hazard Warning Indicators	<ul style="list-style-type: none"> Blinks when you operate the turn signal lever. Blink along with all turn signals when you press the hazard warning button. 	<ul style="list-style-type: none"> Does not blink or blinks rapidly - A turn signal light bulb has blown. Change the bulb immediately.  Replacing Light Bulbs P. 516, 518 	—
	High Beam Indicator	<ul style="list-style-type: none"> Comes on when the high beam headlights are on. 	—	—
	Lights On Indicator	<ul style="list-style-type: none"> Comes on whenever the light switch is on, or in AUTO when the exterior lights are on. 	<ul style="list-style-type: none"> If you remove the key from the ignition switch*¹ while the exterior lights are on, a chime sounds when the driver's door is opened. 	—

*1: Models with the smart entry system have an **ENGINE START/STOP** button instead of an ignition switch.

Indicator	Name	On/Blinking	Explanation	Message*
	Fog Light Indicator*	<ul style="list-style-type: none"> Comes on when the fog lights are on. 	—	—
	Immobilizer System Indicator	<ul style="list-style-type: none"> Comes on briefly when you turn the ignition switch to ON [II]*1, then goes off. Comes on if the immobilizer system cannot recognize the key information. 	<ul style="list-style-type: none"> Blinks - You cannot start the engine. Turn the ignition switch to LOCK [0]*1, pull the key out, and then insert the key and turn it to ON [II]*1 again. Repeatedly blinks - The system may be malfunctioning. Have your vehicle checked by a dealer. Do not attempt to alter this system or add other devices to it. Electrical problems can occur. 	—
	Security System Alarm Indicator	<ul style="list-style-type: none"> Blinks when the security system alarm has been set. 	<p>تلفن شبانه روزی: ۰۲۱-۸۸۶۲۰۸۵</p> <p>Security System Alarm P. 124</p>	—

*1: Models with the smart entry system have an **ENGINE START/STOP** button instead of an ignition switch.











Instrument Panel

Indicator	Name	On/Blinking	Explanation	Message*2	
FCW	Forward Collision Warning (FCW) Indicator*	<ul style="list-style-type: none"> Comes on for a few seconds when you turn the ignition switch to ON [II]*1, then goes off. Comes on when you have customized FCW to turn off. Comes on if there is a problem with the FCW system. 	<ul style="list-style-type: none"> Stays on constantly without FCW off - Have your vehicle checked by a dealer. 		
		<p>Models with information display</p> <ul style="list-style-type: none"> Blinks when the system detects a likely collision with a vehicle in front of you. The beeper sounds. 	<ul style="list-style-type: none"> Blinks while driving - Take appropriate action to prevent a collision (apply the brakes, change lanes, etc.). 	—	—
		<p>All models</p> <ul style="list-style-type: none"> Comes on when the FCW system shuts itself off. 	<p>Models with information display</p> <ul style="list-style-type: none"> Stays on - The temperature inside the FCW system is too high. The system activates when the temperature inside the system cools down. ➤ Automatic shutoff P. 458 		—
		<ul style="list-style-type: none"> Stays on - The radar sensor or the area around the camera is blocked by dirt, mud, etc. Stop your vehicle in a safe place, and wipe it off with a soft cloth. Have your vehicle checked by a dealer if: <ul style="list-style-type: none"> Models with multi-information display The indicator and message stay on after you cleaned the radar sensor cover. Models with information display The indicator and message come back on after you cleaned the area around the camera. ➤ Automatic shutoff P. 458 <p>➤ Automatic shutoff P. 458</p>			

*1: Models with the smart entry system have an **ENGINE START/STOP** button instead of an ignition switch.

*2: On the left: Models with information display On the right: Models with multi-information display

* Not available on all models















Indicator	Name	On/Blinking	Explanation	Message*2
LDW	Lane Departure Warning (LDW) Indicator*	<ul style="list-style-type: none"> Comes on for a few seconds when you turn the ignition switch to ON *1, then goes off. Comes on if there is a problem with the LDW system. 	<ul style="list-style-type: none"> Stays on constantly - Have your vehicle checked by a dealer. 	 
		<p>Models with information display</p> <ul style="list-style-type: none"> Blinks when your vehicle is too close to the lane lines. The beeper sounds. 	<ul style="list-style-type: none"> Blinks while driving - Take appropriate action to keep your vehicle within the lane lines. 	 
		<ul style="list-style-type: none"> Comes on when the LDW system shuts itself off. 	<ul style="list-style-type: none"> Stays on - The temperature inside the LDW camera is too high. The system activates when the temperature inside the camera cools down.  	 
			<ul style="list-style-type: none"> Stays on - The area around the camera is blocked by dirt, mud, etc. Stop your vehicle in a safe place, and wipe it off with a soft cloth. Have your vehicle checked by a dealer if the indicator and message come back on after you cleaned the area around the camera.  	 

Instrument Panel







*1: Models with the smart entry system have an **ENGINE START/STOP** button instead of an ignition switch.

*2: On the left: Models with information display
 On the right: Models with multi-information display

* Not available on all models

Indicator	Name	On/Blinking	Explanation	Message*
	Adaptive Cruise Control (ACC) Indicator (Amber)*	<ul style="list-style-type: none"> Comes on for a few seconds when you turn the ignition switch to ON *1, then goes off. Comes on if there is a problem with ACC. 	<ul style="list-style-type: none"> Comes on while driving - Have your vehicle checked by a dealer. 	
	ECON Mode Indicator	<ul style="list-style-type: none"> Comes on for a few seconds when you turn the ignition switch to ON *1, then goes off. Comes on when you press the ECON button. 	<ul style="list-style-type: none">  ECON Button P. 444 	
	CRUISE MAIN Indicator*	<ul style="list-style-type: none"> Comes on when you press the CRUISE button. 	<ul style="list-style-type: none">  Cruise Control* P. 445 	—
	CRUISE CONTROL Indicator*	<ul style="list-style-type: none"> Comes on if you have set a speed for cruise control. 	<ul style="list-style-type: none">  Cruise Control* P. 445 	—
	Washer Level Indicator*	<ul style="list-style-type: none"> Comes on when the washer fluid gets low. 	<ul style="list-style-type: none"> Refill the washer fluid.  Refilling Window Washer Fluid P. 510 	—
	Maintenance Minder Indicator*	<ul style="list-style-type: none"> Comes on when the scheduled maintenance is due soon. 	<ul style="list-style-type: none">  Maintenance Minder™ P. 487 	—

*1: Models with the smart entry system have an **ENGINE START/STOP** button instead of an ignition switch.



Indicator	Name	On/Blinking	Explanation	Message*
	Smart Entry System Indicator*	<ul style="list-style-type: none"> Comes on for a few seconds when you change the power mode to ON. Comes on as soon as a problem is detected in the smart entry system or push button starting system. 	<ul style="list-style-type: none"> Stays on constantly or does not come on at all - Have your vehicle checked by a dealer. 	 
	Starter System Indicator*	<ul style="list-style-type: none"> Comes on for a few seconds when you turn the ignition switch to ON *1, then goes off. Comes on if the starter system has a problem. 	<ul style="list-style-type: none"> As a temporary measure, press and hold the ENGINE START/STOP button for up to 15 seconds while pressing the brake pedal and manually start the engine. Have your vehicle checked by a dealer. 	—
	Light Control Indicator*	<ul style="list-style-type: none"> Comes on if there is a problem with the automatic lighting control system or low beam headlights*. 	<ul style="list-style-type: none"> Comes on while driving - Turn the lights on manually and have your vehicle checked by a dealer. 	—

*1: Models with the smart entry system have an **ENGINE START/STOP** button instead of an ignition switch.

* Not available on all models

Information Display Warning and Information Messages*

The following messages appear only on the information display.

Message	Condition	Explanation
	<ul style="list-style-type: none"> Appears when the fuel fill cap is loose or is not installed. 	<ul style="list-style-type: none">  Check/Tighten Fuel Cap Message P. 559
	<ul style="list-style-type: none"> Appears when there is a problem with the sensor on the battery. 	<ul style="list-style-type: none"> Stays on constantly - Have your vehicle checked by a dealer.

امداد خودرو فارما

تلفن شبانه روزی: ۰۲۱-۸۸۸۶۲۰۸۵





FarmaSOS.com





Models with smart entry system





Message	Condition	Explanation
<p>Automatic transmission/CVT models</p> 	<ul style="list-style-type: none"> Appears if you push the ENGINE START/STOP button to turn the engine off without the shift lever in P. 	<ul style="list-style-type: none"> Push the ENGINE START/STOP button twice after moving the shift lever to P.
	<ul style="list-style-type: none"> Appears when the power mode is in ACCESSORY. 	—
<p>U.S. manual transmission models</p> <p>Canadian models</p> 	<ul style="list-style-type: none"> Appears when the steering wheel is locked. 	<ul style="list-style-type: none"> Move the steering wheel left and right while pressing the ENGINE START/STOP button at the same time.
NO KEY	<ul style="list-style-type: none"> Appears when you close the door with the power mode in ON without the smart entry remote inside the vehicle. 	<ul style="list-style-type: none"> Disappears when you bring the smart entry remote back inside the vehicle and close the door.
KEY 	<ul style="list-style-type: none"> Appears when the smart entry remote's battery becomes weak. 	<ul style="list-style-type: none"> Replace the battery as soon as possible. <ul style="list-style-type: none"> ► Replacing the Button Battery P. 533





Multi-Information Display Warning and Information Messages*

The following messages appear only on the multi-information display. Press the /▼ (information) button to see the message again with the system message indicator on.

Message	Condition	Explanation
	<ul style="list-style-type: none"> Appears when the fuel fill cap is loose or is not installed. 	<p>➤ Check/Tighten Fuel Cap Message P. 559</p>
	<ul style="list-style-type: none"> Appears when the scheduled maintenance is due soon. <ul style="list-style-type: none"> Consequently, Maintenance Due Now and Maintenance Past Due follow. 	<p>➤ Maintenance Minder Messages on the Multi-Information Display P. 492</p>
	<ul style="list-style-type: none"> Appears when the engine coolant temperature gets abnormally high. 	<p>➤ Overheating P. 556</p>
	<ul style="list-style-type: none"> Appears if there is a problem with the automatic lighting control system. 	<ul style="list-style-type: none"> Appears while driving - Manually turn the lights on, and have your vehicle checked by a dealer.
	<ul style="list-style-type: none"> Appears if there is a problem with the low beam headlights. 	<ul style="list-style-type: none"> Appears while driving - The low beam headlights may not be on. When conditions allow you to drive safely, have your vehicle checked by a dealer as soon as possible.

Message	Condition	Explanation
	<ul style="list-style-type: none"> Appears while you are customizing the settings and the shift lever is moved out of P. 	<p>► Customized Features P. 97</p>
	<ul style="list-style-type: none"> Appears after you unlock and open the driver's door. 	<p>► Starting the Engine P. 427</p>
	<ul style="list-style-type: none"> Appears if you push the ENGINE START/STOP button to turn the engine off without the shift lever in P. 	<ul style="list-style-type: none"> Move the shift lever to P. The power mode changes to VEHICLE OFF.
	<ul style="list-style-type: none"> Appears when the power mode is in ACCESSORY. 	<p>—</p>
	<ul style="list-style-type: none"> Appears after the driver's door is opened when the power mode is in ACCESSORY. 	<ul style="list-style-type: none"> Press the ENGINE START/STOP button twice with your foot off the brake pedal to change the power mode to VEHICLE OFF (LOCK).

Message	Condition	Explanation
	<ul style="list-style-type: none"> Appears when you close the door with the power mode in ON without the smart entry remote inside the vehicle. 	<ul style="list-style-type: none"> Disappears when you bring the smart entry remote back inside the vehicle and close the door. <ul style="list-style-type: none"> ➤ Smart Entry Remote Reminder P. 134
	<ul style="list-style-type: none"> Appears when the smart entry remote battery becomes weak. 	<ul style="list-style-type: none"> Replace the battery as soon as possible. <ul style="list-style-type: none"> ➤ Replacing the Button Battery P. 533
	<ul style="list-style-type: none"> Appears if the smart entry remote battery is too weak to start the engine or the key is not within operating range to start the engine. A beeper sounds six times. 	<ul style="list-style-type: none"> Bring the smart entry remote in front of the ENGINE START/STOP button to be touched with. <ul style="list-style-type: none"> ➤ If the Smart Entry Remote Battery is Weak P. 550
	<ul style="list-style-type: none"> Appears three seconds after the To Start Engine: Brake + Push message appears. Appears three seconds after you bring the smart entry remote in front of the ENGINE START/STOP button when To Start, Hold Remote Near Start Button appears. To Start Engine: Brake + Push appears sequentially. 	<ul style="list-style-type: none"> ➤ Changing the Power Mode P. 132 ➤ Changing the Power Mode P. 132

Message	Condition	Explanation
	<ul style="list-style-type: none"> • Appears when there is a problem with the sensor on the battery. • Appears when the battery is not charging. 	<ul style="list-style-type: none"> • Have your vehicle checked by a dealer. <ul style="list-style-type: none"> ► Checking the Battery P. 532 • Appears along with the battery charging system indicator - Turn off the climate control system and rear defogger to reduce electricity consumption. <ul style="list-style-type: none"> ► If the Charging System Indicator Comes On P. 558
	<ul style="list-style-type: none"> • Appears when the starter system has a problem. 	<ul style="list-style-type: none"> • As a temporary measure, press and hold the ENGINE START/STOP button for up to 15 seconds while pressing the brake pedal and manually start the engine. Have your vehicle checked by a dealer.
	<ul style="list-style-type: none"> • Appears for about three seconds when ACC has been automatically canceled. 	<ul style="list-style-type: none"> • You can resume the set speed after the condition that caused ACC to cancel improves. Press the RES/+ button. <ul style="list-style-type: none"> ► Adaptive Cruise Control (ACC)* P. 448
	<ul style="list-style-type: none"> • Flashes when the system senses a likely collision with a vehicle in front of you. 	<ul style="list-style-type: none"> • Take appropriate action to prevent a collision (apply the brakes, change lanes, etc.). <ul style="list-style-type: none"> ► Adaptive Cruise Control (ACC)* P. 448 ► Forward Collision Warning (FCW)* P. 456
	<ul style="list-style-type: none"> • Appears when your vehicle is too close to the traffic lane lines. The beeper sounds. 	<ul style="list-style-type: none"> • Take appropriate action to keep your vehicle within the lane lines. <ul style="list-style-type: none"> ► Lane Departure Warning (LDW)* P. 460

* Not available on all models

Message	Condition	Explanation
	<ul style="list-style-type: none"> Appears when you press the MAIN button on the steering wheel. 	<p>➤ Adaptive Cruise Control (ACC)* P. 448</p>

امداد خودرو فارما

تلفن شبانه روزی: ۰۲۱-۸۸۸۶۲۰۸۵

FarmaSOS.com

Gauges

Gauges include the speedometer, tachometer, fuel gauge, and related indicators. They are displayed when the ignition switch is in ON ^{*1}.

Speedometer

Displays your driving speed in mph (U.S.) or km/h (Canada).

Tachometer

Shows the number of engine revolutions per minute.

Fuel Gauge

Displays the amount of fuel left in the fuel tank.

Temperature Gauge

Displays the temperature of the engine coolant.

*1: Models with the smart entry system have an **ENGINE START/STOP** button instead of an ignition switch.

Fuel Gauge

NOTICE

You should refuel when the reading approaches . Running out of fuel can cause the engine to misfire, damaging the catalytic converter.

The actual amount of remaining fuel may differ from the fuel gauge reading.

Temperature Gauge

NOTICE

Driving with the temperature gauge pointer in the upper zone can cause serious engine damage. Pull safely to the side of the road and allow engine temperature to return to normal.

➔ **Overheating** P. 556

Information Display *

The information display shows the odometer, trip meter, engine oil life and maintenance service item codes, and other gauges.

Switching the Display

Press the  (Select/Reset) knob to change the display.

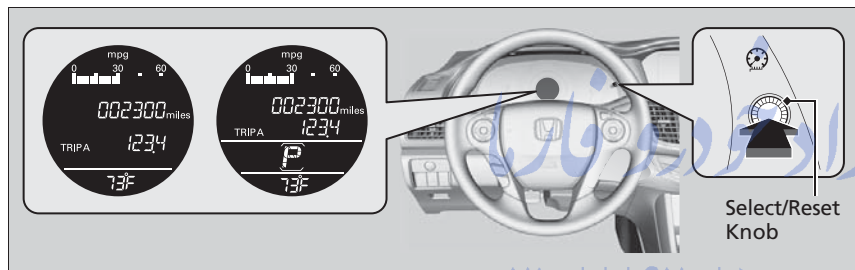

Switching the Display

Each time you press the  knob, the information display changes as follows:

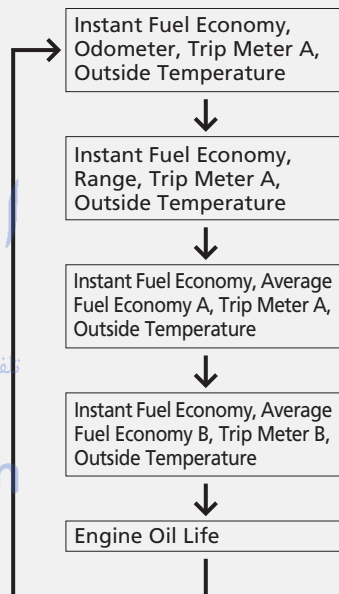

Some of the items on the information display also appear on the audio/information screen. They also change along with the information display changes while the fuel consumption is shown.

■ Odometer

Shows the total number of miles (U.S.) or kilometers (Canada) that your vehicle has accumulated.

■ Trip Meter

Shows the total number of miles (U.S.) or kilometers (Canada) driven since the last reset. Meters A and B can be used to measure two separate trips.

■ Resetting a trip meter

To reset a trip meter, display it, then press and hold the  knob. The trip meter is reset to **0.0**.

■ Average Fuel Economy

Shows the estimated average fuel economy of each trip meter in mpg (U.S.) or l/100 km (Canada). The display is updated at set intervals. When a trip meter is reset, the average fuel economy is also reset.

■ Instant Fuel Economy

Shows the instant fuel economy as a bar graph in mpg (U.S.) or l/100 km (Canada).

■ Engine Oil Life

Shows the remaining oil life and Maintenance Minder™.

➤ **Maintenance Minder™** P. 487

▶▶ Trip Meter

Switch between trip meter A and trip meter B by pressing the  knob.

▶▶ Average Fuel Economy

You can change when to reset the average fuel economy.

➤ **Customized Features** P. 298



Continued

■ Outside Temperature*

Shows the outside temperature in Fahrenheit (U.S.) or Celsius (Canada).

■ Adjusting the outside temperature indicator

Adjust the temperature reading up to $\pm 5^{\circ}\text{F}$ or $\pm 3^{\circ}\text{C}$ if the temperature reading seems incorrect.

1. Turn the ignition switch to ON *1.
2. Press and hold the  (Select/Reset) knob for 10 seconds or more while the outside temperature is shown on the information display.
 - The information display goes into temperature adjustment mode. The display starts showing from -5°F to $+5^{\circ}\text{F}$ (U.S.) or -3°C to $+3^{\circ}\text{C}$ (Canada).
3. Release the  knob when the right adjustment amount is shown.
 - The adjustment is complete.

■ Range

Shows the estimated distance you can travel on the remaining fuel. This distance is estimated from the fuel economy of your previous trips.

►► Outside Temperature*

The temperature sensor is in the front bumper. Road heat and exhaust from another vehicle can affect the temperature reading when your vehicle speed is less than 19 mph (30 km/h).

It may take several minutes for the display to be updated after the temperature reading has stabilized.

تلفن شبانه روزی: ۰۲۱-۸۸۸۶۲۰۸۵

FarmaSOS.com

*1: Models with the smart entry system have an **ENGINE START/STOP** button instead of an ignition switch.

* Not available on all models

Multi-Information Display*

The multi-information display shows the odometer, trip meter, outside temperature indicator, and other gauges. It also displays important messages such as warnings and other helpful information.

It also displays important messages such as warnings and other helpful information.

Switching the Display

Main displays

Press the  (information) button to change the display.

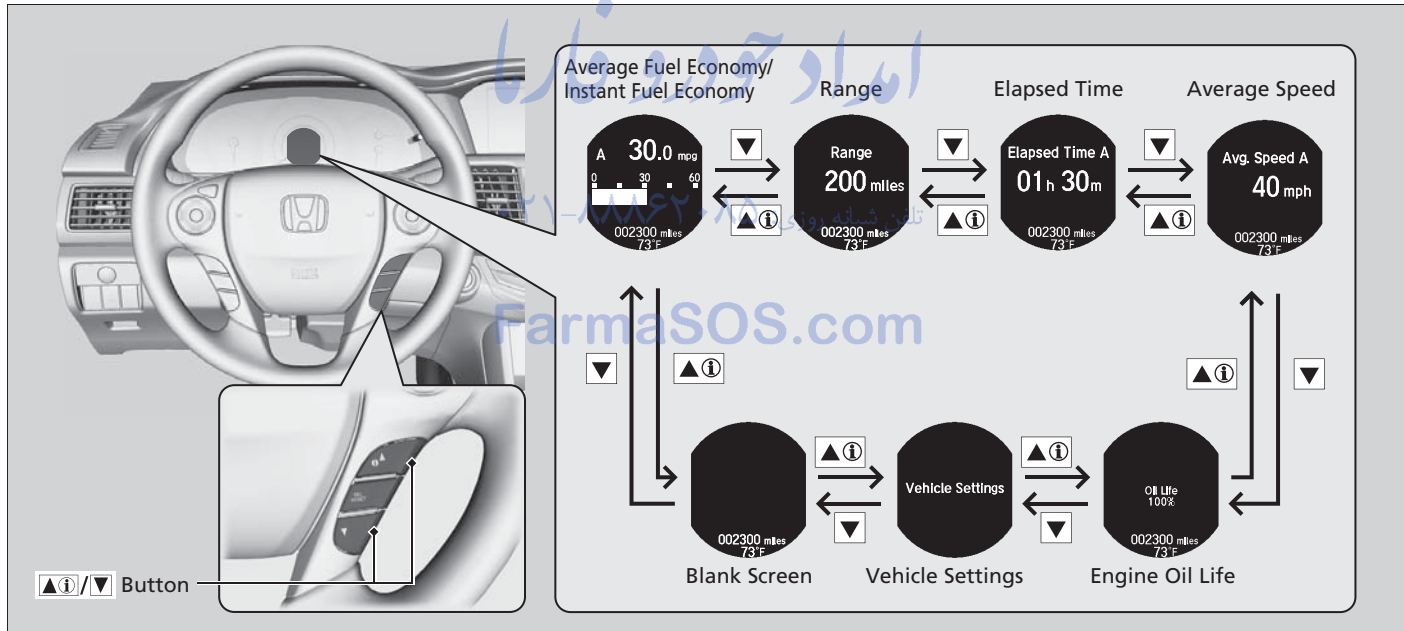

* Not available on all models

■ Lower displays

Press the **SEL/RESET** button to change the display.

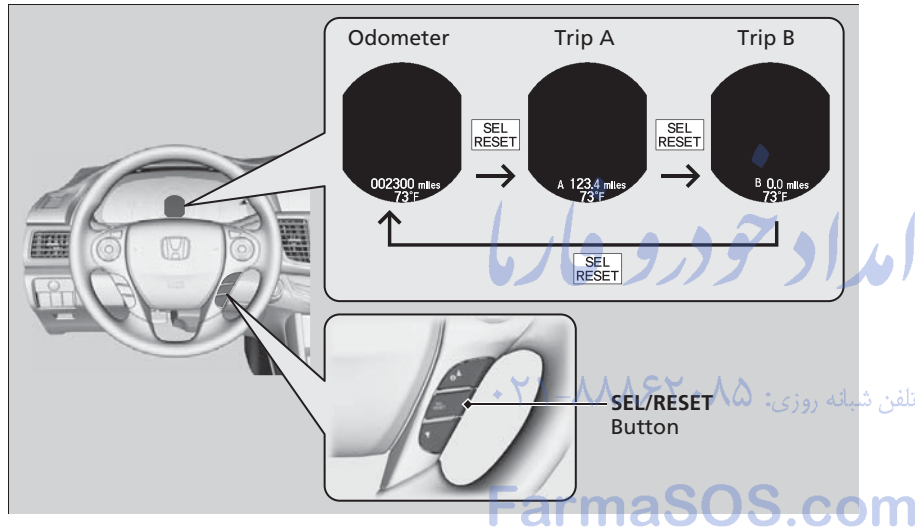

■ Odometer

Shows the total number of miles (U.S.) or kilometers (Canada) that your vehicle has accumulated.

■ Trip Meter

Shows the total number of miles (U.S.) or kilometers (Canada) driven since the last reset. Meters A and B can be used to measure two separate trips.

■ Resetting a trip meter

To reset a trip meter, display it, then press and hold the **SEL/RESET** button. The trip meter is reset to **0.0**.

■ Average Fuel Economy

Shows the estimated average fuel economy of each trip meter in mpg (U.S.) or l/100 km (Canada). The display is updated at set intervals. When a trip meter is reset, the average fuel economy is also reset.

■ Range

Shows the estimated distance you can travel on the remaining fuel. This distance is estimated from the fuel economy of your previous trips.

■ Elapsed Time

Shows the time elapsed since Trip A or Trip B was reset.

▶ Trip Meter

Switch between trip meter A and trip meter B by pressing the **SEL/RESET** button.

▶ Average Fuel Economy

You can change when to reset the average fuel economy.

▶ **Customized Features** P. 97, 298

▶ Elapsed Time

You can change when to reset the elapsed time.

▶ **Customized Features** P. 97, 298

■ Average Speed

Shows the average speed in mph (U.S.) or km/h (Canada) since Trip A or Trip B was reset.

■ Instant Fuel Economy

Shows the instant fuel economy as a bar graph in mpg (U.S.) or l/100 km (Canada).

■ Engine Oil Life

Shows the remaining oil life and Maintenance Minder™.

➤ **Maintenance Minder™** P. 487

■ Outside Temperature

Shows the outside temperature in Fahrenheit (U.S.) or Celsius (Canada).
دما در بیرون خودرو فارسی: دما در بیرون خودرو فارسی

■ Adjusting the outside temperature display

Adjust the temperature reading up to $\pm 5^{\circ}\text{F}$ or $\pm 3^{\circ}\text{C}$ if the temperature reading seems incorrect.

» Average Speed

You can change when to reset the average speed.

➤ **Customized Features** P. 97, 298

» Outside Temperature

The temperature sensor is in the front bumper. Road heat and exhaust from another vehicle can affect the temperature reading when your vehicle speed is less than 19 mph (30 km/h).

It may take several minutes for the display to be updated after the temperature reading has stabilized.

Use the multi-information display's customized features to correct the temperature.

➤ **Customized Features** P. 97, 298

■ Customized Features

Use the multi-information display to customize certain features.

■ How to customize

Select the **Vehicle Settings** screen by pressing the  button while the power mode is in ON, and the vehicle is at a complete stop. Press the **SEL/RESET** button.

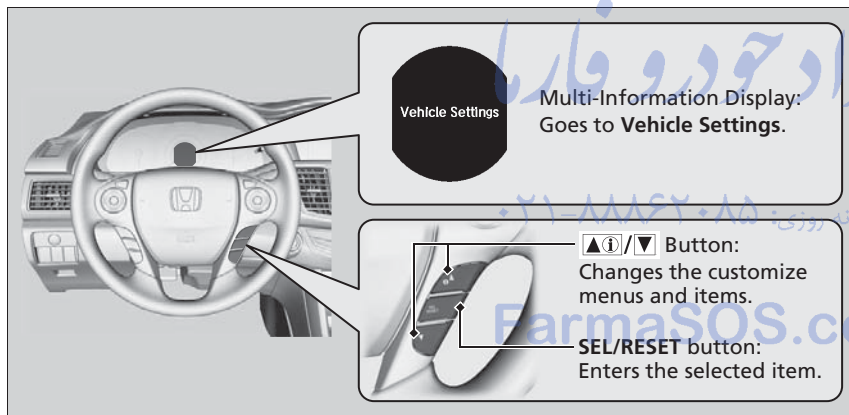

▶ Customized Features

To customize other features, press the  button.

- ▶ **List of customizable options** P. 100
- ▶ **Example of customization settings** P. 103

Customization is possible when you see the driver's ID (**Driver 1** or **Driver 2**) on the screen. The driver's ID indicates which remote transmitter you have used to unlock the driver's door. The customized settings are recalled every time you unlock the driver's door with that remote.

When you customize settings: Shift to 

■ **Customization flow**

Press the /▼ button.

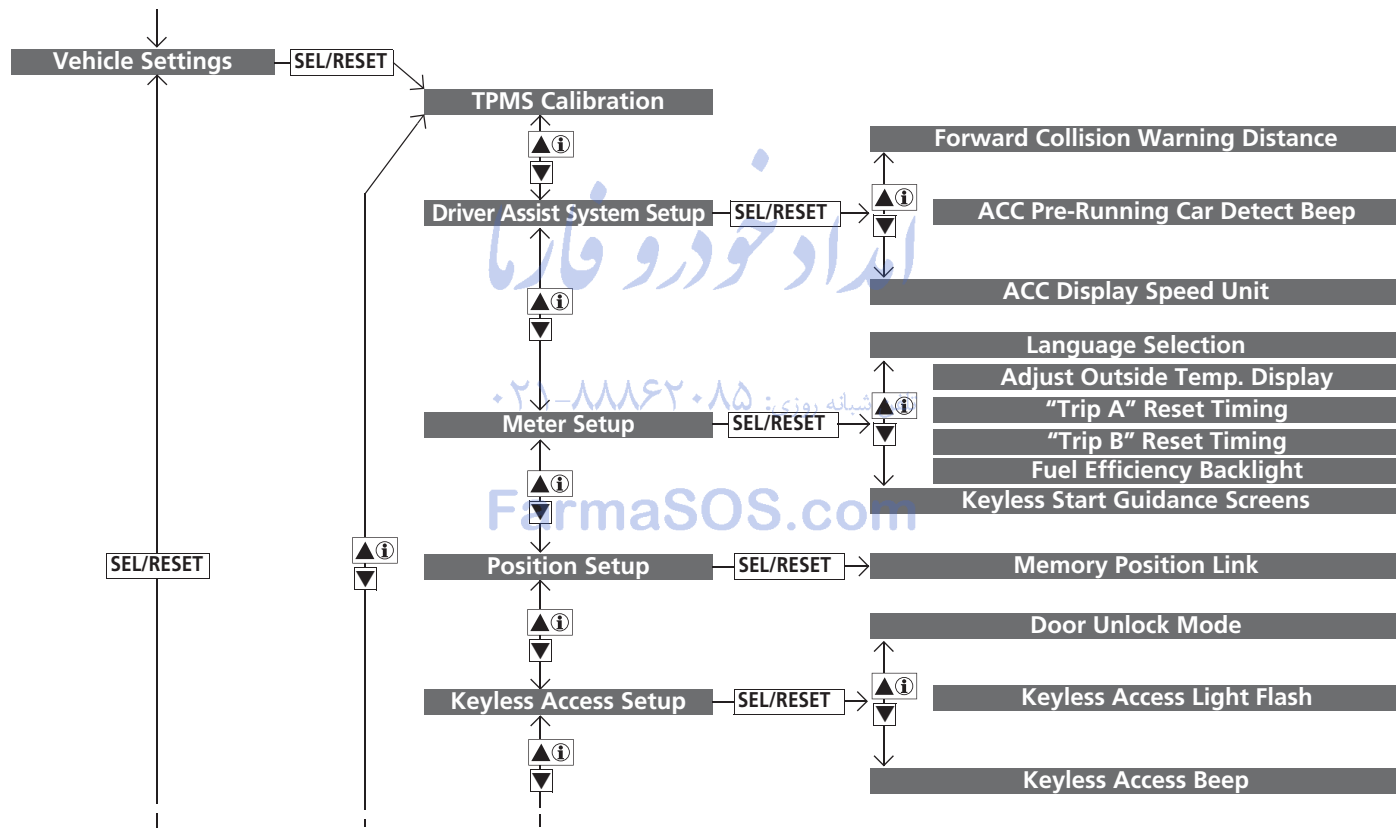

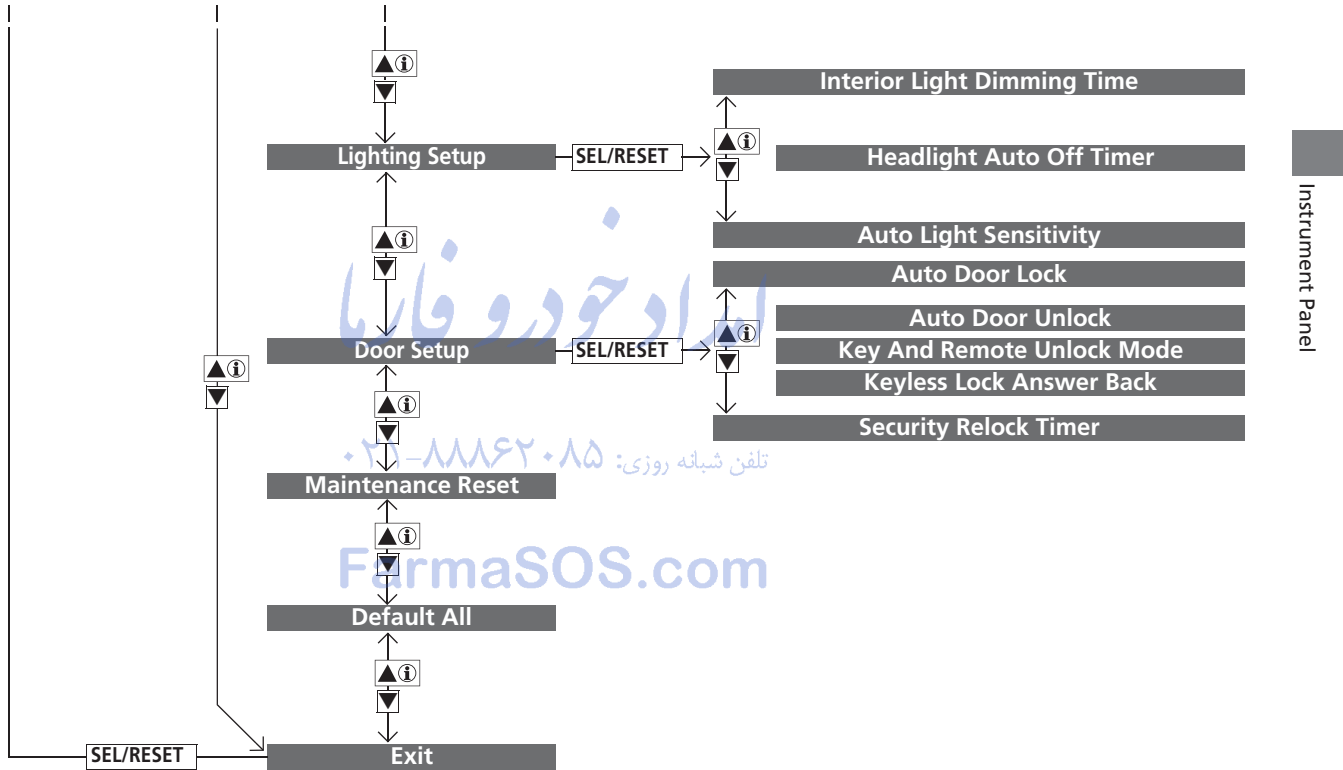

تلفن شبانه روزی: ۰۲۱-۸۸۶۲۰۸۵

FormaSOS.com

■ List of customizable options

Setup Group	Customizable Features	Description	Selectable Settings
TPMS Calibration	—	Calibrates the TPMS.	Cancel/Calibrate
Driver Assist System Setup	Forward Collision Warning Distance	Changes at which distance FCW alerts, or turns FCW on and off.	Long/Normal*¹/Short/Off
	ACC Pre-Running Car Detect Beep	Causes the system to beep when the system detects a vehicle, or when the vehicle goes out of ACC range.	On*¹/Off
	ACC Display Speed Unit	Changes the ACC display speed unit.	mph*¹/km/h
Meter Setup	Language Selection	Changes the displayed language.	English*¹/French/Spanish
	Adjust Outside Temp. Display	Adjusts the temperature reading by a few degrees.	-5°F ~ ±0°F*¹ ~ +5°F
	"Trip A" Reset Timing	Changes the setting of how to reset trip meter A, average fuel economy A, average speed A, and elapsed time A.	With Refuel/IGN Off/Manually Reset*¹
	"Trip B" Reset Timing	Changes the setting of how to reset trip meter B, average fuel economy B, average speed B, and elapsed time B.	With Refuel/IGN Off/Manually Reset*¹
	Fuel Efficiency Backlight	Turns the ambient meter feature on and off.	On*¹/Off
	Keyless Start Guidance Screens	Displays the push button start guidance when conditions are met to change power mode.	On*¹/Off

*1:Default Setting

Setup Group	Customizable Features	Description	Selectable Settings
Driving Position Setup	Memory Position Link	Changes the driver's seat position to a stored setting.	On^{*1}/Off
Keyless Access Setup	Door Unlock Mode	Changes which doors unlock when you grab the driver's door handle.	Driver Door Only^{*1}/All Doors
	Keyless Access Light Flash	Causes some exterior lights to blink when you unlock/lock the doors.	On^{*1}/Off
	Keyless Access Beep	Sets the beeper sound or not when you grab either front door handle.	On^{*1}/Off
Lighting Setup	Interior Light Dimming Time	Changes the length of time the interior lights stay on after you close the doors.	60sec/30sec^{*1}/15sec
	Headlight Auto Off Timer	Changes the length of time the exterior lights stay on after you close the driver's door.	60sec/30sec/15sec^{*1}/0sec
	Auto Light Sensitivity	Changes the timing for the headlights to come on.	Max/High/Mid^{*1}/Low/Min

*1: Default Setting

Setup Group	Customizable Features	Description	Selectable Settings
Door Setup	Auto Door Lock	Changes the setting for when the doors automatically lock.	With Vehicle Speed*¹/Shift from P/Off
	Auto Door Unlock	Changes the setting for when the doors automatically unlock.	All Doors When Driver's Door Opens*¹/All Doors When Shifted To Park/All Doors When Ignition Switched Off/Off
	Key And Remote Unlock Mode	Sets up either the driver's door or all doors to unlock on the first operation of the remote or built-in key.	Driver Door*¹/ All Doors
	Keyless Lock Answer Back	LOCK/UNLOCK- The exterior lights flash. LOCK (2nd push)- The beeper sounds.	On*¹/Off
	Security Relock Timer	Changes the time it takes for the doors to relock and the security system to set after you unlock the vehicle without opening any door.	90sec/60sec/30sec*¹
Maintenance Reset	—	Resets/Cancel the engine oil life display when you have performed the maintenance service.	Cancel/Reset
Default All	—	Cancels/Resets all the customized settings as default.	Cancel/Set

*1: Default Setting

■ Example of customization settings

The steps for changing the “Trip A” **Reset Timing** setting to **With Refuel** are shown below. The default setting for “Trip A” **Reset Timing** is **Manually Reset**.

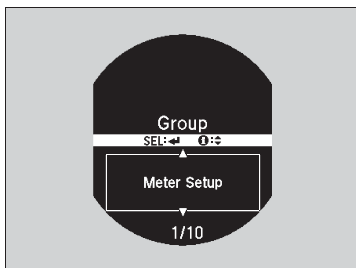
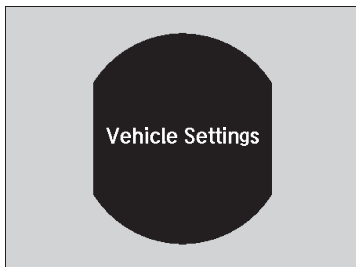

1. Press the /▼ button to select **Vehicle Settings**, then press the **SEL/RESET** button.

2. Press the /▼ button until **Meter Setup** appears on the display.

3. Press the **SEL/RESET** button.

▶ **Language Selection** appears first in the display. تلفن شبکه: ۰۲۱-۸۸۸۶۰۰۸۸

FarmaSOS.com

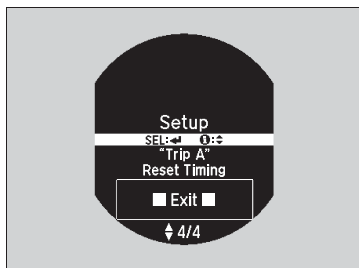
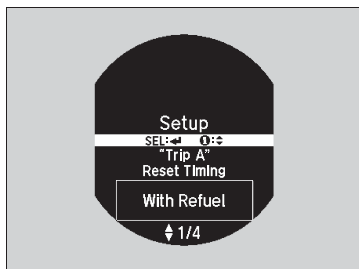
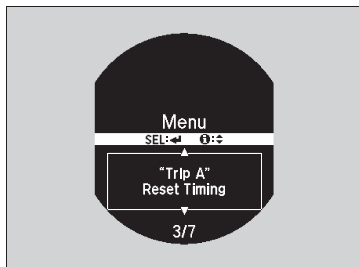

4. Press the /▼ button until **"Trip A" Reset Timing** appears on the display, then press the **SEL/RESET** button.

▶ The display switches to the customization setup screen, where you can select **With Refuel, IGN Off, Manually Reset, or Exit**.

5. Press the /▼ button and select **With Refuel**, then press the **SEL/RESET** button.

▶ The **With Refuel Setup** screen appears, then the display returns to the customization menu screen.

تلفن شبانه روزی: ۰۲۱-۸۸۸۶۲۰۸۵

6. Press the /▼ button until **Exit** appears on the display, then press the **SEL/RESET** button.

7. Repeat Step 6 until you return to the normal screen.

Controls

This chapter explains how to operate the various controls necessary for driving.

امداد خودرو فارما

تلفن شبانه روزی: ۰۲۱-۸۸۸۶۲۰۸۵

Clack	106
Locking and Unlocking the Doors	
Key Types and Functions	108
Low Smart Entry Remote Signal Strength*	110
Locking/Unlocking the Doors from the Inside	116
Childproof Door Locks	118
Auto Door Locking/Unlocking	119
Opening and Closing the Trunk	120
Security System	
Immobilizer System	124
Security System Alarm	124
Opening and Closing the Windows	127
Opening and Closing the Moonroof* ..	130

Operating the Switches Around the Steering Wheel	
Ignition Switch*	131
ENGINE START/STOP Button*	132
Ignition Switch and Power Mode Comparison	135
Turn Signals	136
Light Switches.....	136
Fog Lights*	138
Daytime Running Lights	139
Wipers and Washers	140
Brightness Control	141
Rear Defogger/Heated Door Mirror* Button	142

Driving Position Memory System*	143
Adjusting the Steering Wheel	145
Adjusting the Mirrors	
Interior Rearview Mirror	146
Power Door Mirrors	147
Adjusting the Seats	148
Interior Lights/Interior Convenience Items	156
Heating and Cooling*	
Using Vents, Heating and A/C.....	166
Climate Control System*	
Using Automatic Climate Control	169
Synchronized Mode	171
Automatic Climate Control Sensors...	172

* Not available on all models

Adjusting the Clock

Models without navigation system

You can adjust the time in the clock display with the ignition switch is in ON  *1.

Adjusting the Time

Using the Settings menu on the audio/information screen

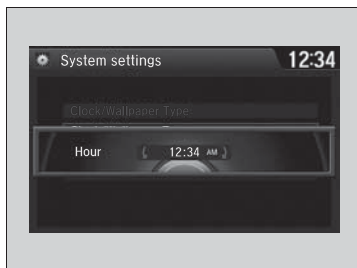







Models with one display

1. Press the **SETTINGS** button.

Models with two displays

1. Press and hold the **DISP** button.

All models

2. Rotate  to select **System Settings**, then press .
 - ▶ Repeat the procedure to select **Clock**, then **Clock Adjustment**.
3. Rotate  to change hour, then press .
4. Rotate  to change minute, then press .



Adjusting the Clock

Models with navigation system

The clock is automatically updated through the navigation system, so the time does not need to be adjusted.

Models without navigation system

These indications are used to show how to operate the selector knob.

Rotate  to select.
Press  to enter.

You can customize the clock display to show the 12 hour clock or 24 hour clock.

 **Customized Features** P. 298

You can turn the clock display on and off.

 **Customized Features** P. 298

*1: Models with the smart entry system have an **ENGINE START/STOP** button instead of an ignition switch.

Models with one display

■ Using the SETTINGS button

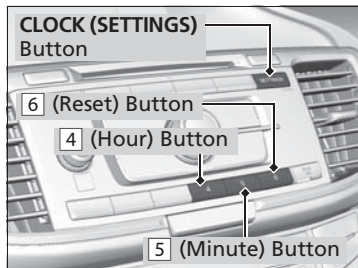

1. Press and hold the **CLOCK (SETTINGS)** button until the clock display blinks.
2. Press Preset **4** (Hour) or **5** (Minute) to adjust the time.
3. Press the **CLOCK** button again to set the time.

▶ Using the SETTINGS button

To set the time to the nearest hour: Press and hold the **CLOCK** button until the clock display blinks, then press the **6** (Reset) button.

Depending on the displayed time, the clock sets forward or backward.

Example:

1:06 will reset to 1:00

1:53 will reset to 2:00

Models with two displays

■ Using the audio with touch screen

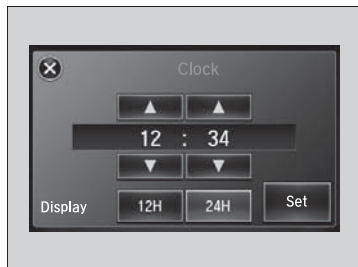

1. Select **Clock**.
2. Adjust the hours and minutes by selecting **▲/▼**.
3. Select **12H** or **24H**.
4. Press **Set** to set the time.

Key Types and Functions

This vehicle comes with the following keys:

Master Keys

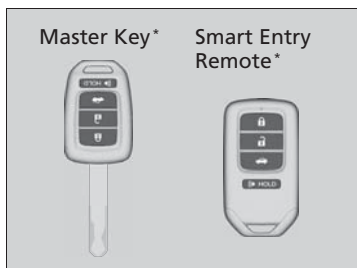

Use the key to start and stop the engine, to lock and unlock the doors and to open the trunk. You can also use the remote transmitter or smart entry system* to lock and unlock the doors and to open the trunk.

Smart entry remote*

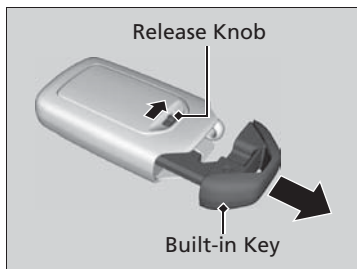

The built-in key can be used to lock/unlock the doors when the smart entry remote battery becomes weak and the power door lock/unlock operation is disabled.

To remove the built-in key, pull it out while sliding the release knob. To reinstall the built-in key, push the built-in key into the smart entry remote until it clicks.

Key Types and Functions

All the keys have an immobilizer system. The immobilizer system helps to protect against vehicle theft.

Immobilizer System P. 124

The keys contain precision electronics. Adhere to the following advice to prevent damage to the electronics:

- Do not leave the keys in direct sunlight, or in locations with high temperature or high humidity.
- Do not drop the keys or set heavy objects on them.
- Keep the keys away from liquids.
- Do not take the keys apart except for replacing the battery.

If the circuits in the keys are damaged, the engine may not start, and the remote transmitter may not work.

If the keys do not work properly, have them inspected by a dealer.

■ Valet Key*

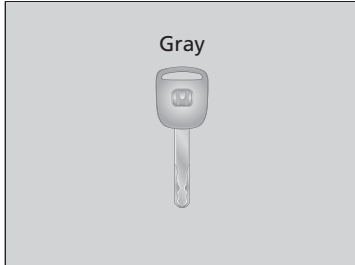

Can be used to start and stop the engine, and lock and unlock driver's door.

▣ Valet Key*

When you need to leave a key with a third party, leave the valet key.

■ Key Number Tag

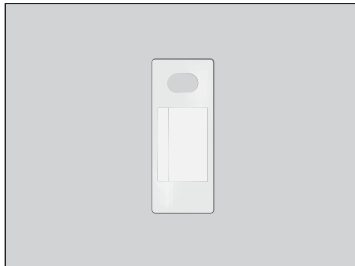

Contains a number that you will need if you purchase a replacement key.

▣ Key Number Tag

Keep the key number tag separate from the key in a safe place outside of your vehicle.

If you wish to purchase an additional key, contact a dealer.

If you lose your key and you cannot start the engine, contact a dealer.

امداد خودرو فارما

FarmaSOS.com

* Not available on all models

Low Smart Entry Remote Signal Strength *

The vehicle transmits radio waves to locate the smart entry remote when locking/unlocking the doors, opening the trunk, or to start the engine.

In the following cases, locking/unlocking the doors, opening the trunk, or starting the engine may be inhibited or operation may be unstable:

- Strong radio waves are being transmitted by nearby equipment.
- You are carrying the smart entry remote together with telecommunications equipment, laptop computers, cell phones, or wireless devices.
- A metallic object is touching or covering the smart entry remote.

Low Smart Entry Remote Signal Strength *

Communication between the smart entry remote and the vehicle consumes the smart entry remote's battery.

Battery life is about two years, but this varies depending on regularity of use.

The battery is consumed whenever the smart entry remote is receiving strong radio waves. Avoid placing it near electrical appliances such as televisions and personal computers.

امداد خودرو فارما

تلفن شبانه روزی: ۰۲۱-۸۸۸۶۲۰۸۵

FarmaSOS.com

Locking/Unlocking the Doors from the Outside

Using the Remote Transmitter

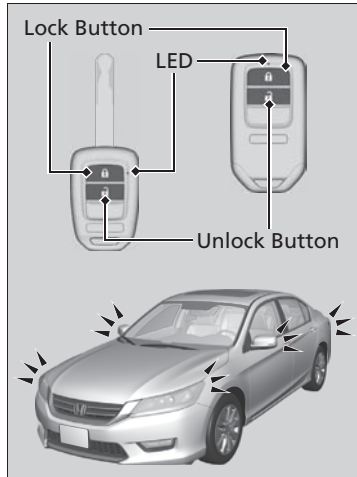

■ Locking the doors

Press the lock button.

Once:

- ▶ Some exterior lights flash, all the doors lock, and the security system sets.

Twice (within five seconds after the first push):

- ▶ The beeper sounds and verifies the security system is set.

✎ Using the Remote Transmitter

If you do not open a door within 30 seconds of unlocking the vehicle with the remote transmitter, the doors will automatically relock.

You can change the relock timer setting.

✎ **Customized Features** P. 97, 298

If the interior light switch is in the door activated position, the interior lights come on when you press the unlock button.

No doors opened: The lights fade out after 30 seconds.

Doors relocked with the remote: The lights go off immediately.

✎ **Interior Lights** P. 156

The remote transmitter uses low-power signals, so the operating range may vary depending on the surroundings.

Models without smart entry system

The remote transmitter will not work when the key is in the ignition switch.

Models with smart entry system

You can lock or unlock doors using the remote transmitter or smart entry system only when the power mode is VEHICLE OFF.

All models

The remote will not lock the vehicle when a door is open.

■ Unlocking the doors

Press the unlock button.

Once:

- ▶ Some exterior lights flash twice, and the driver's door unlocks.

Twice:

- ▶ The remaining doors unlock.

☒ Using the Remote Transmitter

If the distance at which the remote transmitter works varies, the battery is probably low.

If the LED does not come on when you press a button, the battery is dead.

- ☒ **Replacing the Button Battery** P. 533

You can customize the door unlock mode setting.

- ☒ **Customized Features** P. 97, 298

امداد خودرو فارما

تلفن شبانه روزی: ۰۲۱-۸۸۸۶۲۰۸۵

FarmaSOS.com

■ Using the Smart Entry with Push Button Start System*

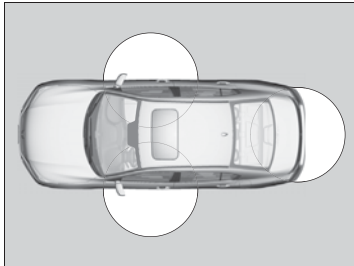

When you carry the smart entry remote, you can lock/unlock the doors and open the trunk. You can lock/unlock the doors within a radius of about 32 inches (80 cm) of the outside door handle. You can open the trunk within about 32 inches (80 cm) radius from the trunk release button.

▶ Using the Smart Entry with Push Button Start System*

- Do not leave the smart entry remote in the vehicle when you get out. Carry it with you.
- Even if you are not carrying the smart entry remote, you can lock/unlock the doors while someone else with the remote is within range.
- The door may be unlocked if the door handle is covered with water in heavy rain or in a car wash if the smart entry remote is within range.
- If you grip a front door handle wearing gloves, the door sensor may be slow to respond or may not respond by unlocking the doors.
- You cannot unlock the door by gripping the handle after two seconds of unlocking it.
- The door might not open if you pull it immediately after gripping the door handle. Grip the handle again and confirm that the door is unlocked before pulling the handle.
- Even within the 32 inches (80 cm) radius, you may not be able to lock/unlock the doors with the smart entry remote if it is above or below the outside handle.
- The smart entry remote may not operate if it is too close to the door and door glass.

If the distance at which the remote transmitter works varies, the battery is probably low.

If the LED does not come on when you press a button, the battery is dead.

▶ **Replacing the Button Battery** P. 533

You can customize the door lock mode and keyless lock acknowledgement setting.

▶ **Customized Features** P. 97, 298

■ Locking the doors and the trunk

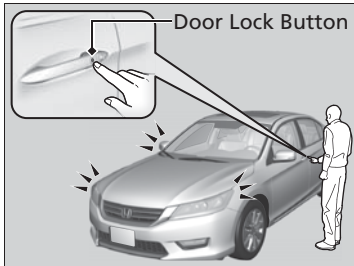

Press the door lock button on the front door.

- ▶ Some exterior lights flash; the beeper sounds; all the doors lock; and the security system sets.

FarmaSOS.com

* Not available on all models

■ Unlocking the doors and the trunk

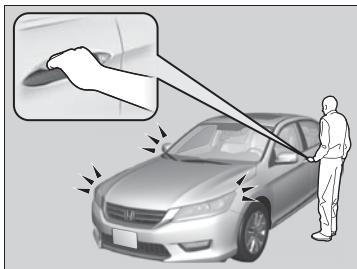

Grab the driver's door handle:

- ▶ The driver's door unlocks.
- ▶ Some exterior lights flash twice and the beeper sounds twice.

Grab the front passenger's door handle:

- ▶ All the doors unlock.
- ▶ Some exterior lights flash twice and the beeper sounds twice.

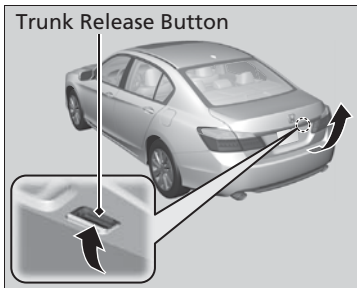

Press the trunk release button:

- ▶ The trunk unlocks and opens.

▶ **Using the Trunk Release Button*** P. 121

▶▶ Using the Smart Entry with Push Button Start System *

If you do not open a door within 30 seconds of unlocking the vehicle, the doors will automatically relock.

The light flash, beep and unlock settings can be customized.

▶ **Customized Features** P. 97, 298

■ Locking/Unlocking the Doors Using a Key

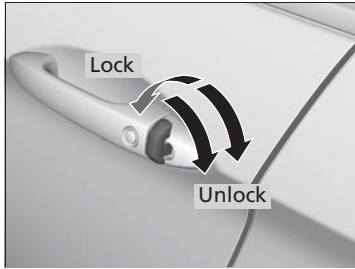

Fully insert the key and turn it.

☒ Locking/Unlocking the Doors Using a Key

When you lock the driver's door with a key, all the other doors lock at the same time. When unlocking, the driver's door unlocks first. Turn the key a second time within a few seconds to unlock the remaining doors.

You can customize the door unlock mode setting.

☒ **Customized Features** P. 97, 298

■ Locking a Door Without Using a Key

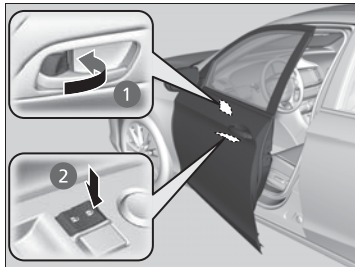

■ Locking the driver's door

Push the lock tab forward **1** or push the master door lock switch in the lock direction **2**, and close the door.

■ Locking the passenger's doors

Push the lock tab forward and close the door.

☒ Locking a Door Without Using a Key

When you lock the driver's door, all the other doors lock at the same time.

Make sure you have the key in your hand before locking the door to prevent it from being locked in the vehicle.

■ Lockout prevention system

The doors cannot be locked when the key is in the ignition switch*1, or the smart entry remote is inside the vehicle.

*1: Models with the smart entry system have an **ENGINE START/STOP** button instead of an ignition switch.

Locking/Unlocking the Doors from the Inside

■ Using the Lock Tab

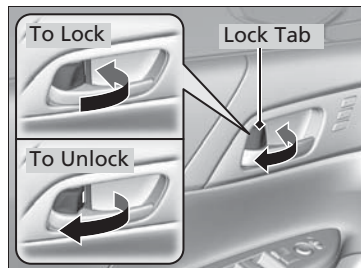

■ Locking a door

Push the lock tab forward.

■ Unlocking a door

Pull the lock tab rearward.

▶ Using the Lock Tab

When you lock the door using the lock tab on the driver's door, all the other doors lock at the same time.

When you unlock the door using the lock tab on the driver's door, only the driver's door will unlock.

امداد خودرو فارما

تلفن شبانه روزی: ۰۲۱-۸۸۸۶۲۰۸۵

FarmaSOS.com

■ Unlocking Using the Front Door Inner Handle

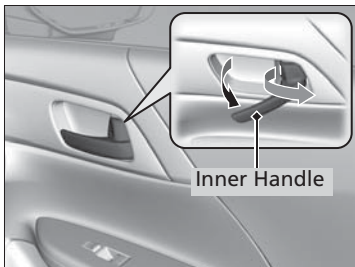

Pull the front door inner handle.

- ▶ The door unlocks and opens in one motion.

■ Unlocking Using the Front Door Inner Handle

The inner front door handles are designed to allow front seat occupants to open the door in one motion. However this feature requires that front seat occupants never pull a front door inner handle while the vehicle is in motion.

Children should always ride in a rear seat where childproof door locks are provided.

- ▶ **Childproof Door Locks** P. 118

Unlocking and opening the driver's door from the inner handle unlocks all the other doors.

To avoid all the doors to be unlocked, use the lock tab on the driver's door to unlock, then lock again before opening the door.

- ▶ This setting works for one time only. If you do not want all the doors to be unlocked all the time, customize the **Auto Door Unlock** setting to **Off** using the multi-information display* or audio/information screen.

* Not available on all models

■ Using the Master Door Lock Switch

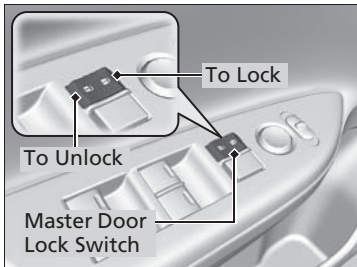

Press the master door lock switch in as shown to lock or unlock all doors.

▶▶ Using the Master Door Lock Switch

When you lock/unlock the driver's door using the master lock switch, all the other doors lock/unlock at the same time.

Childproof Door Locks

The childproof door locks prevent the rear doors from being opened from the inside regardless of the position of the lock tab.

▶▶ Childproof Door Locks

To open the door from the inside when the childproof door lock is on, put the lock tab in the unlock position, lower the rear window, put your hand out of the window, and pull the outside door handle.

■ Setting the Childproof Door Locks

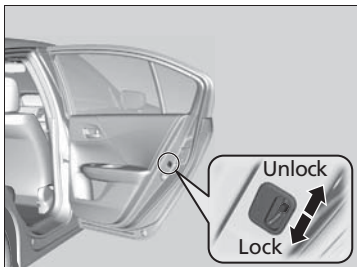

Slide the lever in the rear door to the lock position, and close the door.

■ When opening the door

Open the door using the outside door handle.

Auto Door Locking/Unlocking

Your vehicle locks and unlocks all doors automatically when a certain condition is met.

Auto Door Locking

■ Drive lock mode

All doors lock when the vehicle's speed reaches about 10 mph (15 km/h).

Auto Door Unlocking

■ Driver's door open mode

All doors unlock when the driver's door is opened.

Auto Door Locking/Unlocking

You can turn off or change to another auto door locking/unlocking setting using the audio/information screen or multi-information display*.

▶ **Customized Features** P. 97, 298

امداد خودرو فارما

تلفن شبانه روزی: ۰۲۱-۸۸۸۶۲۰۸۵

FarmaSOS.com

* Not available on all models

Precautions for Opening/Closing the Trunk

■ Opening the trunk

Open the trunk all the way.

- ▶ If it is not fully opened, the trunk lid may begin to close under its own weight.

■ Closing the trunk

Keep the trunk lid closed while driving to:

- ▶ Avoid possible damage.
- ▶ Prevent exhaust gas from leaking into the vehicle.
- ☑ **Exhaust Gas Hazard** P. 64

Using the Trunk Opener

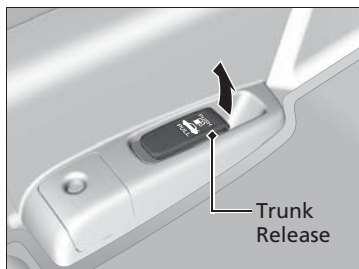

Pulling the trunk release to the lower left of the driver's seat unlocks and opens the trunk.

تلفن شبانه روزی: ۰۲۱-۸۸۸۶۲۰۸۵

FarmaSOS.com

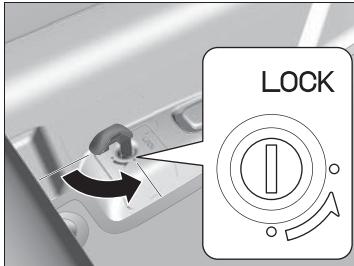

■ Locking the trunk opener

You can lock the trunk release with the master key* or the built-in key*.

▶ Locking the trunk opener

Models without smart entry system

If you need to give the key to someone else, give them the valet key.

Using the Trunk Release Button*

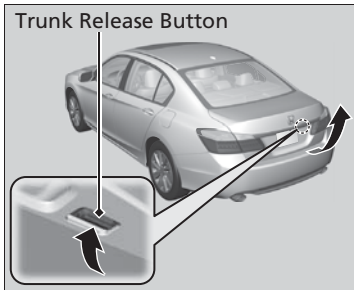

Push up the release button on the trunk lid after the doors are unlocked.

Even if the trunk is locked, you can open the trunk if you carry the smart entry remote.

- ▶ The beeper will sound.

▶ Using the Trunk Release Button*

- Do not leave the smart entry remote in the vehicle when you get out. Carry it with you.
- A person who is not carrying the smart entry remote can unlock the trunk if a person who is carrying it is within range.
- Do not leave the smart entry remote inside the trunk and close the lid. The beeper sounds and the trunk cannot be closed.
- Do not carry the smart entry remote near the trunk lid when closing it.
- Do not place the smart entry remote around the rear seat when closing the trunk.

* Not available on all models

Using the Remote Transmitter

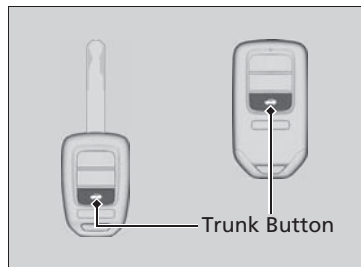

Press the trunk release button for approximately one second to unlock and open the trunk.

Trunk Main Switch*

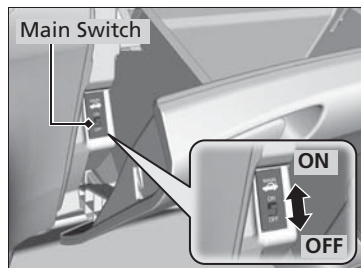

The trunk main switch disables the trunk release button on the remote transmitter and the trunk release button on the trunk lid to protect luggage in the trunk.

1. Make sure the rear seat-back is not folded down.
2. Turn off the trunk main switch in the glove box.
3. Lock the glove box.
4. Lock the trunk release.

► **Using the Trunk Opener** P. 120

► Trunk Main Switch*

If you need to give the key to someone else, remove the built-in key from the smart entry remote by sliding the release knob, and give the remote as a valet key.

Emergency Trunk Opener

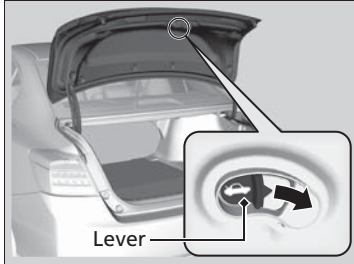

The trunk release lever allows you to open the trunk from inside for your safety.

Slide the release lever in the direction of the arrow.

Emergency Trunk Opener

Parents should decide if their children should be shown how to use this feature.

امداد خودرو فارما

تلفن شبانه روزی: ۰۲۱-۸۸۸۶۲۰۸۵

FarmaSOS.com

Immobilizer System

The immobilizer system prevents a key that has not been pre-registered from starting the engine. Each key contains electronic transmitters that use electronic signals to verify the key.

Pay attention to the following when inserting the key into the ignition switch or pressing the **ENGINE START/STOP** button:

- Do not allow objects that emit strong radio waves near the ignition switch or the **ENGINE START/STOP** button.
- Make sure the key is not covered by or touching a metal object.
- Do not bring a key from another vehicle's immobilizer system near the ignition switch.

Security System Alarm

The security system alarm activates when the trunk, hood or doors are forcibly opened. The alarm does not go off if the trunk or doors are opened with the key, remote transmitter or smart entry system.

However, the alarm goes off when a door is opened with the key, then the shift lever is moved out of **P** (automatic transmission/CVT models) or the hood is opened before the ignition switch is turned to ON **III***1.

■ When the security system alarm activates

The horn sounds intermittently and all the exterior lights flash.

■ To deactivate the security system alarm

Unlock the vehicle using the remote transmitter, or smart entry system. The system, along with the horn and flashing lights, is deactivated.

*1: Models with the smart entry system have an **ENGINE START/STOP** button instead of an ignition switch.

» Immobilizer System

NOTICE

Leaving the ignition key in the vehicle can result in theft or accidental movement of the vehicle. Always take the ignition key with you whenever you leave the vehicle unattended.

Do not alter the system or add other devices to it. Doing so may damage the system and make your vehicle inoperable.

» Security System Alarm

The security alarm continues for a maximum of two minutes until the security system deactivates.

■ Setting the security system alarm

The security system alarm automatically sets when the following conditions have been met:

- The ignition switch is in LOCK [0]*1, and the key has been removed from the ignition switch.
- The hood and trunk are closed.
- All doors are locked from outside with the key, the remote transmitter, or smart entry system.

■ When the security system alarm sets

The security system alarm indicator in the instrument panel blinks. When the blinking interval changes after about 15 seconds, the security system is set.

■ To cancel the security system alarm

The security system alarm is canceled when the vehicle is unlocked using the remote transmitter, smart entry system, or the ignition switch is turned to ON [II]*1. The security system indicator goes off at the same time.

*1: Models with the smart entry system have an **ENGINE START/STOP** button instead of an ignition switch.

☒ Security System Alarm

Do not set the security system alarm when someone is in the vehicle or a window is open. The system can accidentally activate when:

- Unlocking the door with the lock tab.
- Opening the trunk with the trunk release or the emergency trunk opener.
- Opening the hood with the hood release.

Automatic transmission/CVT models

- Moving the shift lever out of [P].

If the battery goes dead after you have set the security system alarm, the security alarm may go off once the battery is recharged or replaced. If this occurs, deactivate the security system alarm by unlocking a door using the key or remote transmitter.

Do not attempt to alter this system or add another device to it.

■ Panic Mode

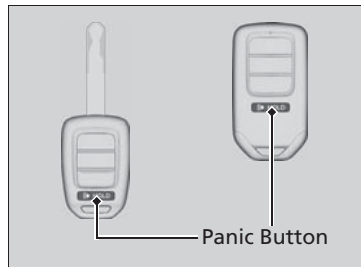

■ The panic button on the remote transmitter

If you press the panic button for approximately one second, the following will occur for about 30 seconds:

- The horn sounds.
- Some exterior lights flash.

■ Canceling panic mode

Press any button on the remote transmitter, or turn the ignition switch to ON *1.

تلفن شبانه روزی: ۰۲۱-۸۸۸۶۲۰۸۵

FarmaSOS.com

*1: Models with the smart entry system have an **ENGINE START/STOP** button instead of an ignition switch.

Opening/Closing the Power Windows

The power windows can be opened and closed when the ignition switch is in ON *1, using the switches on the doors. The driver's side switches can be used to open and close all of the windows.

The power window lock button on the driver's side must be switched off (not pushed in, indicator off) to open and close the windows from anywhere other than the driver's seat.

When the power window lock button is pushed in, you can only operate the driver's window. Turn the power window lock button on when children are in the vehicle.

Opening/Closing Windows with Auto-Open/Close Function

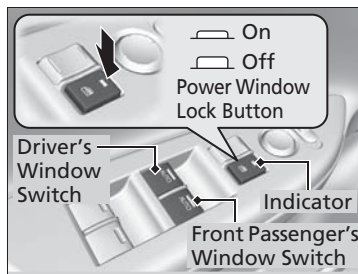

Automatic operation

To open: Push the switch down firmly.

To close: Pull the switch up firmly.

The window opens or closes completely. To stop the window at any time, push or pull the switch briefly.

Manual operation

To open: Push the switch down lightly, and hold it until the desired position is reached.

To close: Pull the switch up lightly, and hold it until the desired position is reached.

Opening/Closing the Power Windows

WARNING

Closing a power window on someone's hands or fingers can cause serious injury.

Make sure your passengers are away from the windows before closing them.

The power windows can be operated for up to 10 minutes after you turn the ignition switch to LOCK *1.

Opening either front door cancels this function.

Auto Reverse

If a power window senses resistance when closing automatically, it stops closing and reverse direction.

The driver's window auto reverse function is disabled when you continuously pull up the switch.

The auto reverse function stops sensing when the window is almost closed to ensure that it fully closes.

*1: Models with the smart entry system have an **ENGINE START/STOP** button instead of an ignition switch.

■ Opening/Closing Windows without Auto-Open/Close Function

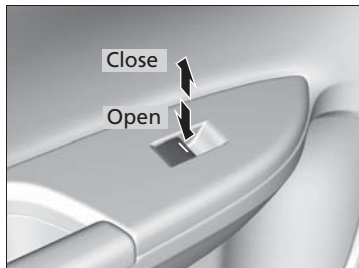

To open: Push the switch down.

To close: Pull the switch up.

Release the switch when the window reaches the desired position.

■ Opening Windows and Moonroof with the Remote *

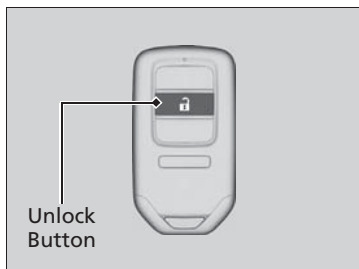

To open: Press the unlock button twice within 10 seconds and hold it down for the second time. If the windows stop midway, تلفن شبانه repeat the procedure.

FarmaSOS.com

■ Opening/Closing the Windows and Moonroof with the Key*

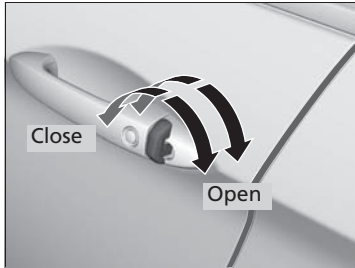

To open: Unlock the driver's door with the key. Within 10 seconds of returning the key to the central position, turn the key in the unlock direction and hold it there.

To close: Lock the driver's door with the key. Within 10 seconds of returning the key to the central position, turn the key in the lock direction and hold it there.

Release the key to stop the windows/moonroof at the desired position. If you want further adjustment, repeat the same operation.

تلفن شبانه روزی: ۰۲۱-۸۸۸۶۲۰۸۵

FarmaSOS.com

* Not available on all models

Opening/Closing the Moonroof

You can only operate the moonroof when the ignition switch is in ON **II***1. Use the switch in the front of the ceiling to open and close the moonroof.

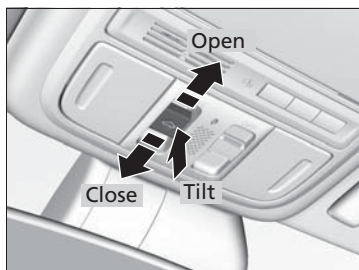

Automatic operation

To open: Pull the switch back firmly.

To close: Push the switch forward firmly.

The moonroof will automatically open or close all the way. To stop the moonroof midway, touch the switch briefly.

Manual operation

To open: Pull the switch back lightly, and hold it until the desired position is reached.

To close: Push the switch forward lightly, and hold it until the desired position is reached.

Tilting the moonroof up

To tilt: Push on the center of the moonroof switch.

To close: Push the switch forward firmly, then release.

*1: Models with the smart entry system have an **ENGINE START/STOP** button instead of an ignition switch.

Opening/Closing the Moonroof

⚠ WARNING

Opening or closing the moonroof on someone's hands or fingers can cause serious injury.

Make sure all hands and fingers are clear of the moonroof before opening or closing it.

NOTICE

Opening the moonroof in below freezing temperature or when it is covered with snow or ice can damage the moonroof panel or motor.

The power moonroof can be operated for up to 10 minutes after you turn the ignition switch off. Opening either front door cancels this function.

When resistance is detected, the auto reverse function causes the moonroof to change directions, then stop. Auto reverse stops sensing when the moonroof is almost closed to ensure that it fully closes. Make sure that all objects, including fingers, are clear of the moonroof.

Ignition Switch*

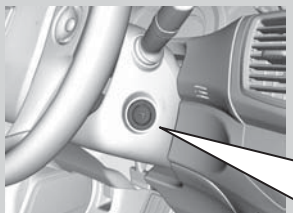

- 0** LOCK: Insert and remove the key in this position.
- I** ACCESSORY: Operate the audio system and other accessories in this position.
- II** ON: This is the position when driving.
- III** START: This position is for starting the engine. The switch returns to ON **II** when you let go of the key.

Ignition Switch*

Manual transmission models

⚠ WARNING

Removing the key from the ignition switch while driving locks the steering. This can cause you to lose control of the vehicle.

Remove the key from the ignition switch only when parked.

Continuously variable transmission (CVT) models

You cannot take the key out unless the shift lever is in **P**.

All models

If you open the driver's door when the key is in LOCK **0** or ACCESSORY **I**, a warning buzzer will sound to remind you to take the key out.

If the key won't turn from LOCK **0** to ACCESSORY **I**, turn the key while moving the steering wheel left and right. The steering wheel will unlock, allowing the key to turn.

* Not available on all models

ENGINE START/STOP Button*

Changing the Power Mode

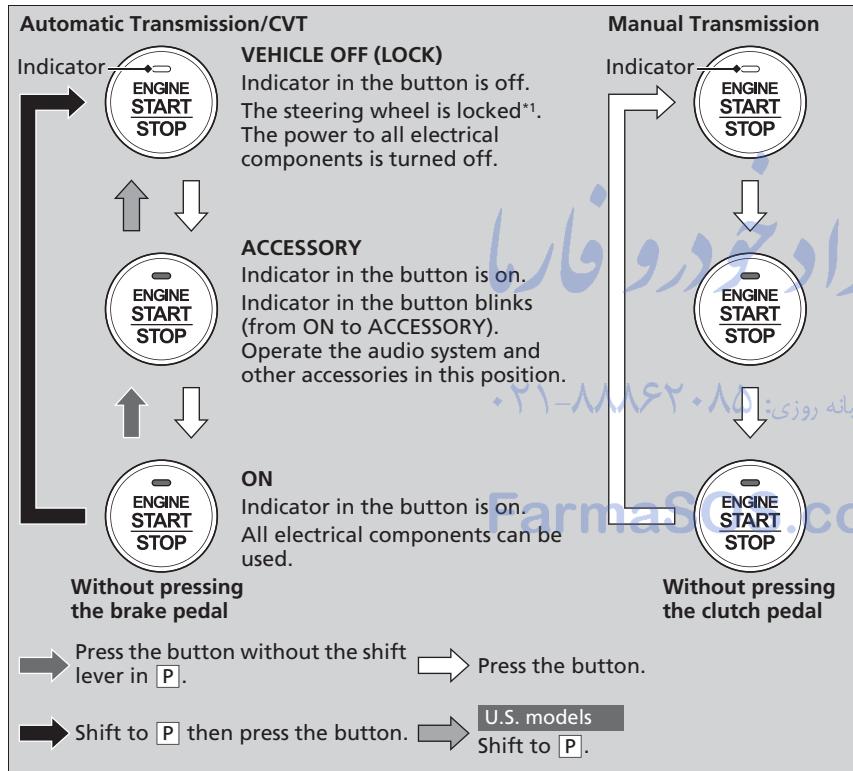

*1: Except U.S. automatic transmission/CVT models

ENGINE START/STOP Button*

ENGINE START/STOP Button Operating Range

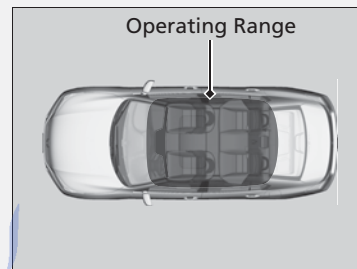

You can start the engine when the smart entry remote is inside the vehicle.
The engine may also run if the smart entry remote is close to the door or window, even if it is outside the vehicle.

ON mode:
Indicator in the button is off, if the engine is running.

If the smart entry remote battery is weak, beeper sounds and the **To Start, Hold Remote Near Start Button** message appears on the multi-information display*.

❏ **If the Smart Entry Remote Battery is Weak**
P. 550

Do not leave the power mode in ACCESSORY or ON when you get out.

Automatic Power Off

If you leave the vehicle for 30 to 60 minutes with the shift lever in **P***1 and the power mode in ACCESSORY, the vehicle automatically goes into the mode similar to VEHICLE OFF (LOCK) to avoid the battery drain.

When in this mode:

Except U.S. automatic transmission/CVT models

The steering wheel does not lock.

All models

You cannot lock or unlock doors with the remote transmitter or the smart entry system.

Press the **ENGINE START/STOP** button to switch the mode to VEHICLE OFF (LOCK).

Power Mode Reminder

If you open the driver's door when the power mode is set to ACCESSORY, a warning buzzer sounds.

Changing the Power Mode

Except U.S. automatic transmission/CVT models

If the power mode does not change from VEHICLE OFF to ACCESSORY, press the **ENGINE START/STOP** button while moving the steering wheel left and right. The steering wheel will unlock, allowing the mode to change.

اداره خودرو فارما

تلفن شبانه روزی: ۰۲۱-۸۸۸۶۲۰۸۵

FarmaSOS.com

Controls

*1: Automatic transmission/CVT models

Smart Entry Remote Reminder

Models with information display



Models with multi-information display



Warning buzzers may sound from inside or/ and outside the vehicle to remind you that the smart entry remote is out of the vehicle. If the buzzer continues even after the remote is put back inside, place it to be within its operational range.

■ When the power mode is in ON

If the smart entry remote is taken out of the vehicle, and the driver's door is closed, warning buzzers sound from both inside and outside the vehicle. A warning message on the information display or multi-information display notifies the driver inside that the remote is out.

■ When the power mode is in ACCESSORY

If the smart entry remote is taken out of the vehicle, and all the doors are closed, a warning buzzer sounds from outside the vehicle.

Smart Entry Remote Reminder

When the smart entry remote is within the system's operational range, and the driver's door is closed, the warning function cancels.

If the smart entry remote is taken out of the vehicle after the engine has been started, you can no longer change the **ENGINE START/STOP** button mode or restart the engine. Always make sure if the remote is in your vehicle when you operate the **ENGINE START/STOP** button.

Removing the smart entry remote from the vehicle through a window does not activate the warning buzzer.

Do not put the smart entry remote on the dashboard or in the glove box. It may cause the warning buzzer to go off. Under some other conditions that can prevent the vehicle from locating the remote, the warning buzzer may also go off even if the remote is within the system's operational range.

Ignition Switch and Power Mode Comparison

Ignition Switch Position	LOCK (0) (with/without the key)	ACCESSORY (I)	ON (II)	START (III)
Without Smart Entry System	<ul style="list-style-type: none"> Engine is turned off and power is shut down. The steering wheel is locked. No electrical components can be used. 	<ul style="list-style-type: none"> Engine is turned off. Some electrical components such as the audio system and the accessory power socket can be operated. 	<ul style="list-style-type: none"> Normal key position while driving. All electrical components can be used. 	<ul style="list-style-type: none"> Use this position to start the engine. The ignition switch returns to the ON (II) position when you release the key.
Power Mode	VEHICLE OFF (LOCK)	ACCESSORY	ON	START
With Smart Entry System and ENGINE START/STOP Button	Indicator-Off <ul style="list-style-type: none"> Engine is turned off and power is shut down. The steering wheel is locked*1. No electrical components can be used. 	Indicator-On or blinking <ul style="list-style-type: none"> Engine is turned off. Some electrical components such as the audio system and the accessory power socket can be operated. 	Indicator-On (engine is turned off) Off (engine is running) <ul style="list-style-type: none"> All electrical components can be used. 	Indicator-Off <ul style="list-style-type: none"> The mode automatically returns to ON after the engine starts.

*1:Except U.S. automatic transmission/CVT models

Turn Signals

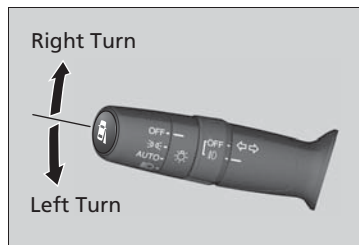

The turn signals can be used when the ignition switch is in ON **II***1.

■ One-touch turn signal

When you lightly push up or down and release the turn signal lever, the exterior turn signals and turn signal indicator blink three times.

This feature can be used when signaling for a lane change.

Light Switches

■ Manual Operation

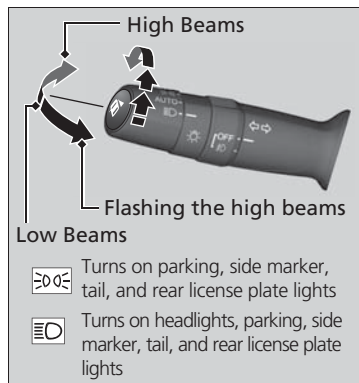

Rotating the light switch turns the lights on and off, regardless of the position of the ignition switch*1.

■ High beams

Push the lever forward until you hear a click.

■ Low beams

When in high beams, pull the lever back to return to low beams.

■ Flashing the high beams

Pull the lever back, and release it.

*1: Models with the smart entry system have an **ENGINE START/STOP** button instead of an ignition switch.

▶▶ Light Switches

If you remove the key from the ignition switch while the lights are on, a chime sounds when the driver's door is opened.

When the lights are on, the lights on indicator in the instrument panel will be on.

▶▶ Lights On Indicator P. 76

If you sense that the level of the headlights is abnormal, have the vehicle inspected by a dealer.

Do not leave the lights on when the engine is off because it will cause the battery to discharge.

Automatic Lighting Control

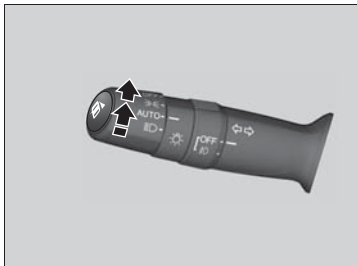

Automatic lighting control can be used when the ignition switch is in ON *1.

When you turn the light switch to **AUTO**, the headlights and other exterior lights will switch on and off automatically depending on the ambient brightness.

► You can change the auto light sensitivity setting.

► **Customized Features** P. 97, 298

Automatic Lighting Control

We recommend that you turn on the lights manually when driving at night, in a dense fog, or in dark areas such as long tunnels or parking facilities.

The light sensor is in the location shown below. Do not cover this light sensor with anything; otherwise, the automatic lighting system may not work properly.

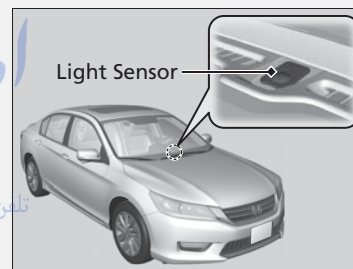

Adjust the auto light sensitivity as follows:

Setting	The exterior lights come on when the ambient light is at
MAX	 <p>Bright</p> <p>Dark</p>
HIGH	
MID	
LOW	
MIN	

*1: Models with the smart entry system have an **ENGINE START/STOP** button instead of an ignition switch.

Headlight Integration with Wipers*

The headlights automatically come on when the wipers are used several times within a certain number of intervals with the headlight switch in **AUTO**. The headlights automatically go off a few minutes later if the wipers are stopped.

Automatic Lighting Off Feature

The headlights, all other exterior lights, and the instrument panel lights turn off 15 seconds after you remove the key or set the power mode to VEHICLE OFF (LOCK), take the remote with you, and close the driver's door.

▶ You can change the headlight auto off timer setting.

➤ **Customized Features** P. 97, 298

If you turn the ignition switch to LOCK [0]*¹ with the headlight switch on, but do not open the door, the lights turn off after 10 minutes (three minutes, if the switch is in the **AUTO** position).

The lights turn on again when you unlock or open the driver's door. If you unlock the door, but do not open it within 15 seconds, the lights go off. If you open the driver's door, you will hear a lights on reminder chime.

Fog Lights*



When the low beam headlights are on, turn the fog light switch on to use the fog lights.

*1: Models with the smart entry system have an **ENGINE START/STOP** button instead of an ignition switch.

* Not available on all models

Headlight Integration with Wipers*

This feature activates while the headlights are off in **AUTO**.

The instrument panel brightness does not change when the headlights come on.

At dark ambient light levels, the automatic lighting control feature turns on the headlights, regardless of the number of wiper sweeps.

Fog Lights*

When the fog lights are on, the indicator in the instrument panel will be on.

They go off when the headlights turn off, or when the daytime running lights are on.

➤ **Fog Light Indicator*** P. 77



Daytime Running Lights

Models with bulb type parking lights

The high beam headlights come on slightly dimmer than normal when the following conditions have been met:

Models with LED type parking/daytime running lights

The parking/daytime running lights come on when the following conditions have been met:

- The ignition switch is in ON *1.
- The headlight switch is off, or in .
- The parking brake is released.

The lights remain on even if you set the parking brake. Turning off the ignition switch or setting the power mode to VEHICLE OFF will turn off the daytime running lights.

Models with bulb type parking lights

The high beam headlights return to the original brightness once the headlight switch is turned on.

FarmaSOS.com

*1: Models with the smart entry system have an **ENGINE START/STOP** button instead of an ignition switch.

Wipers and Washers

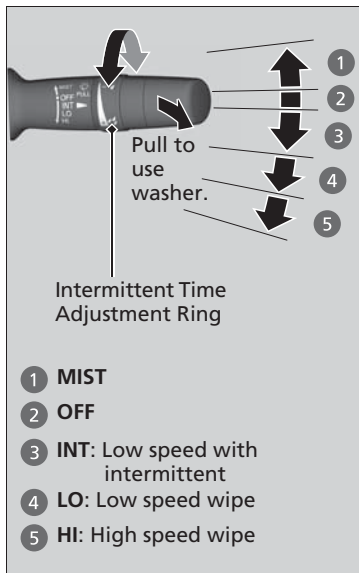

The windshield wipers and washers can be used when the ignition switch is in ON *1.

■ MIST

The wipers run at high speed until you release the lever.

■ Wiper switch (OFF, INT, LO, HI)

Change the wiper switch setting according to the amount of rain.

■ Adjusting the delay

Turn the adjustment ring to adjust the wiper delay.



Long delay

Short delay

■ Washer

Sprays while you pull the lever toward you. When you release the lever, the wipers make two or three more sweeps before stopping.

*1: Models with the smart entry system have an **ENGINE START/STOP** button instead of an ignition switch.

▶▶ Wipers and Washers

NOTICE

Do not use the wipers when the windshield is dry. The windshield will get scratched, or the rubber blades will get damaged.

NOTICE

In cold weather, the blades may freeze to the windshield, becoming stuck. Operating the wipers in this condition may damage the wipers. Use the defroster to warm the windshield, then turn the wipers on.

If the vehicle speeds up while the wipers are operating intermittently, the length of the wipe interval shortens. When the vehicle starts moving, the wipers make a single sweep. When the vehicle speeds up, the wiper operation's shortest delay setting and the **LO** setting become the same.

Turn the washers off if no washer fluid comes out. The pump may get damaged.

The wiper motor is equipped with a breaker that may stop motor operation temporarily to prevent an overload. Wiper operation will return to normal within a few minutes, once the circuit has returned to normal.

If the wipers stop operating due to any obstacle such as the build-up of snow, park the vehicle in a safe place.

Rotate the wiper switch to **OFF**, and turn the ignition switch to ACCESSORY or LOCK *1, then remove the obstacle.

Brightness Control



When the parking lights are turned on and the ignition switch is in ON **II***1, you can use the brightness control knob to adjust instrument panel brightness.

Brighten: Turn the knob to the right.

Dim: Turn the knob to the left.

You will hear a beep when the brightness reaches minimum or maximum. The information display*/multi-information display* will return to its original state several seconds after you adjust the brightness.

☒ Brightness Control

Instrument panel brightness varies, depending on whether the exterior lights are on or off. The instrument panel dims to reduce glare when they are on.

Pressing the  (Select/Reset) knob switches the display.

If you turn the knob to the right until the brightness display is up to max, the beeper sounds. This cancels the reduced instrument panel brightness when the parking lights are on.

The brightness can be set differently for when the exterior lights are on, and when they are off.

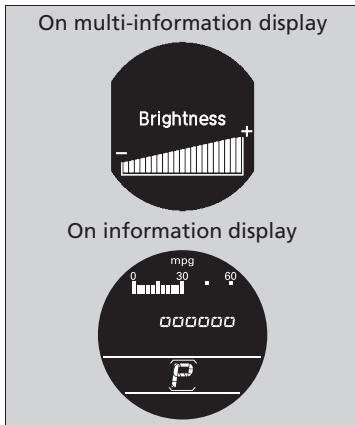

■ Brightness level indicator

The brightness level is shown on the information display*/multi-information display* while you are adjusting it.

FarmaSOS.com

*1: Models with the smart entry system have an **ENGINE START/STOP** button instead of an ignition switch.

* Not available on all models

Rear Defogger/Heated Door Mirror* Button

Press the rear defogger and heated door mirror button to defog the rear window and mirrors when the ignition switch is in ON *1.



Models with heating and cooling system

The rear defogger and heated door mirrors automatically switch off after 20 minutes. However, if the outside temperature is 18°F (-8°C) or below, they do not automatically switch off.

Models with climate control system

The rear defogger and heated door mirrors automatically switch off after 10-30 minutes depending on the outside temperature. However, if the outside temperature is 32°F (0°C) or below, they do not automatically switch off.

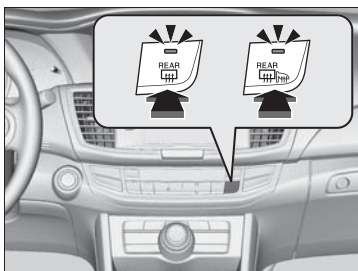

▶▶ Rear Defogger/Heated Door Mirror* Button

NOTICE

When cleaning the inside of the rear window, be careful not to damage the heating wires. It is critical to wipe the window from side to side along the defogger heating wires.

This system consumes a lot of power, so turn it off when the window has been defogged. Also, do not use the system for a long period when the engine is idling. This may weaken the battery, making it difficult to start the engine.

*1: Models with the smart entry system have an **ENGINE START/STOP** button instead of an ignition switch.

Driving Position Memory System*

You can store two driver's seat positions with the driving position memory system. When you unlock and open the driver's door with a remote, the seat adjusts automatically to one of the two preset positions.

The multi-information display* shows you which remote you used to unlock the vehicle when you enter.

- **DRIVER 1** transmitter is linked to memory button 1.
- **DRIVER 2** transmitter is linked to memory button 2.

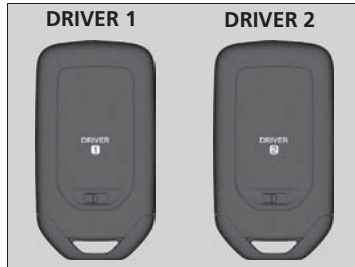

▶▶ Driving Position Memory System*

Using the audio/information screen or multi-information display, you can disable the automatic seat adjustment function.

▶▶ **Customized Features** P. 97, 298

امداد خودرو فارما

تلفن شبانه روزی: ۰۲۱-۸۸۸۶۲۰۸۵

FarmaSOS.com

* Not available on all models

Storing a Position in Memory

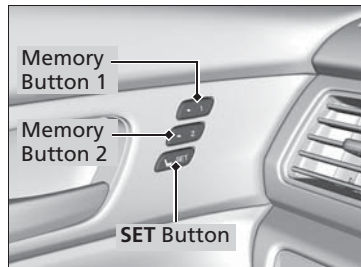

1. Set the power mode to ON. Adjust the driver's seat to the desired position.
2. Press the **SET** button.
 - ▶ You will hear a beep, and the memory button indicator light will blink.
3. Press and hold memory button **1** or **2** within five seconds of pressing the **SET** button.
 - ▶ Once the seat position has been memorized, the indicator light on the button you pressed stays on.

Recalling the Stored Position

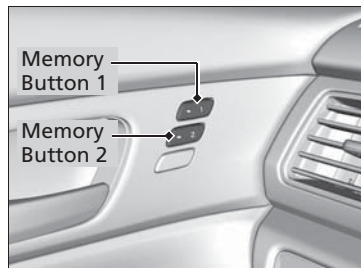

Automatic transmission/CVT models

1. Move the shift lever to **P**.
2. Apply the parking brake.
3. Press a memory button (**1** or **2**).
 - ▶ You will hear a beep, and the indicator light will blink.

The seat will automatically move to the memorized position. When it has finished moving, you will hear a beep, and the indicator light stays on.

All models

Storing a Position in Memory

After you press the **SET** button, the storing operation will be canceled when:

- You do not press the memory button within five seconds.
- You readjust the seat position before the double-beep.
- You set the power mode to any position except ON.

Recalling the Stored Position

The seat will stop moving if you:

- Press the **SET** button, or a memory button (**1** or **2**).
- Adjust the seat position.
- **Automatic transmission/CVT models**
Shift into any position except **P**.
- **Manual transmission models**
Release the parking brake.

Adjusting the Steering Wheel

The steering wheel height and distance from your body can be adjusted so that you can comfortably grip the steering wheel in an appropriate driving posture.

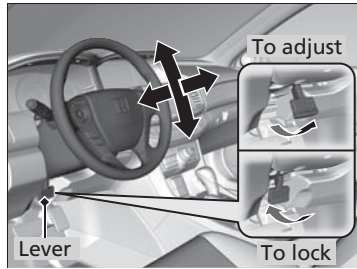

1. Pull the steering wheel adjustment lever up.
 - ▶ The steering wheel adjustment lever is under the steering column.
2. Move the steering wheel up or down, and in or out.
 - ▶ Make sure you can see the instrument panel gauges and indicators.
3. Push the steering wheel adjustment lever down to lock the steering wheel in position.
 - ▶ After adjusting the position, make sure you have securely locked the steering wheel in place by trying to move it up, down, in, and out.

تلفن شبانه روزی: ۰۲۱-۸۸۶۲۰۸۵

FarmaSOS.com

Adjusting the Steering Wheel

WARNING

Adjusting the steering wheel position while driving may cause you to lose control of the vehicle and be seriously injured in a crash.

Adjust the steering wheel only when the vehicle is stopped.

Make any steering wheel adjustments before you start driving.

Interior Rearview Mirror

Adjust the angle of the rearview mirror when you are sitting in the correct driving position.

Rearview Mirror with Day and Night Positions*

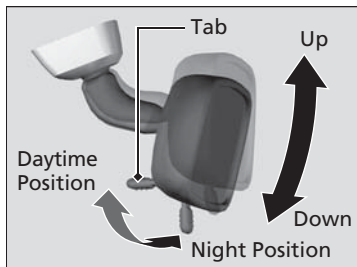

Flip the tab to switch the position. The night position will help to reduce the glare from headlights behind you when driving after dark.

Automatic Dimming Rearview Mirror*

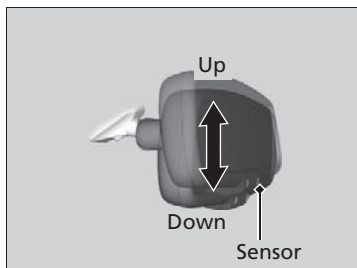

When driving after dark, the automatic dimming rearview mirror reduces the glare from headlights behind you, based in inputs from the mirror sensor. This feature is always active.

Adjusting the Mirrors

Keep the inside and outside mirrors clean and adjusted for best visibility.

Adjust the mirrors before you start driving.

➤ **Adjusting the Seat Positions** P. 148

Automatic Dimming Rearview Mirror*

The auto dimming function cancels when the shift position is in **[R]**.

Power Door Mirrors

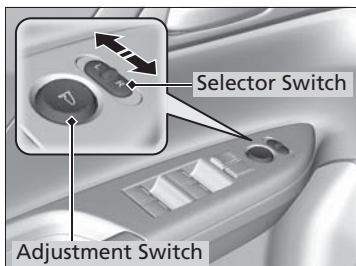

You can adjust the door mirrors when the ignition switch is in ON ^{*1}.

■ Mirror position adjustment

L/R selector switch: Select the left or right mirror. After adjusting the mirror, return the switch to the center position.

Mirror position adjustment switch: Press the switch left, right, up, or down to move the mirror.

■ Expanded View Driver's Mirror

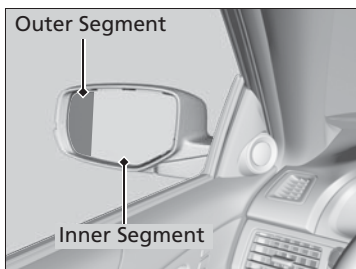

The driver side door mirror has outer and inner segments.

The outer segment is slightly curved to provide a wider angle view than a standard flat mirror. This wider view may help you check areas that are not visible using a standard door mirror.

▣ Expanded View Driver's Mirror

Objects visible in the outer segment of the driver side door mirror appear smaller than objects in the rest of the mirror. But in fact, they are closer than they appear.

Do not rely on your mirrors. Always look to the side and behind your vehicle before changing lanes.

*1: Models with the smart entry system have an **ENGINE START/STOP** button instead of an ignition switch.

Adjusting the Seat Positions

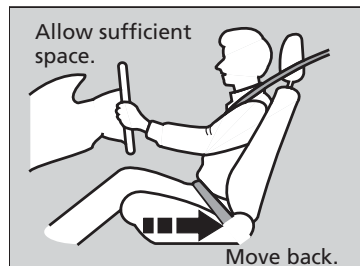

Adjust the driver's seat as far back as possible while allowing you to maintain full control of the vehicle. You should be able to sit upright, well back in the seat and be able to adequately press the pedals without leaning forward, and grip the steering wheel comfortably. The passenger's seat should be adjusted in a similar manner, so that it is as far back from the front airbag in the dashboard as possible.

Adjusting the Seats

WARNING

Sitting too close to a front airbag can result in serious injury or death if the front airbags inflate.

Always sit as far back from the front airbags as possible while maintaining control of the vehicle.

The National Highway Traffic Safety Administration and Transport Canada recommend that drivers allow at least 10 inches (25 cm) between the center of the steering wheel and the chest.

Always make seat adjustments before driving.

Adjusting the front power seat(s)*

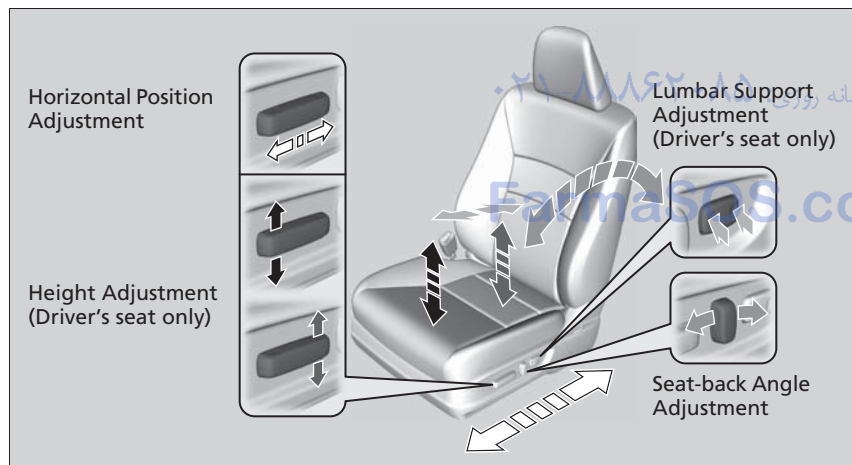

■ Adjusting the front manual seat(s)*

▣ Adjusting the front manual seat(s)*

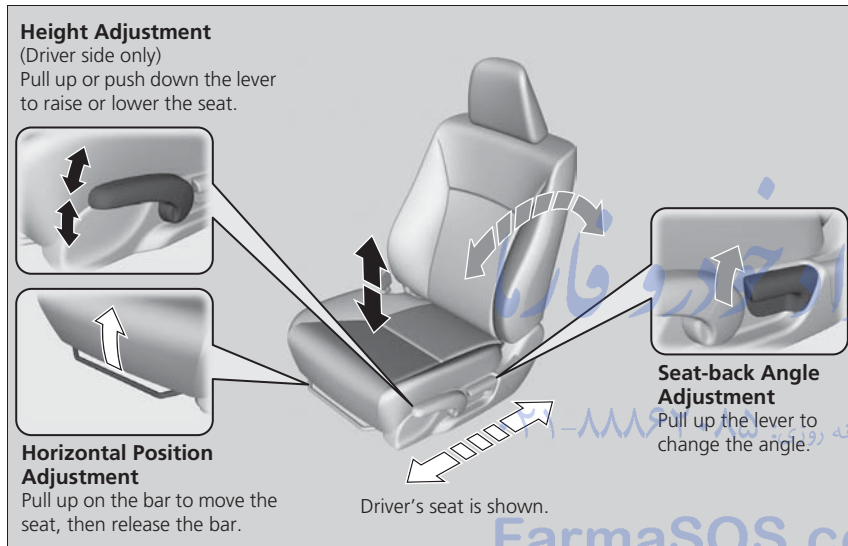

Once a seat is adjusted correctly, rock it back and forth to make sure it is locked in position.

* Not available on all models

■ Adjusting the Seat-Backs

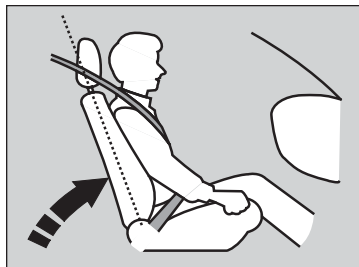

Adjust the driver's seat-back to a comfortable, upright position, leaving ample space between your chest and the airbag cover in the center of the steering wheel.

The front seat passenger should also adjust their seat-back to a comfortable, upright position.

Reclining a seat-back so that the shoulder part of the belt no longer rests against the occupant's chest reduces the protective capability of the belt. It also increases the chance of sliding under the belt in a crash and being seriously injured. The farther a seat-back is reclined, the greater the risk of injury.

▶▶ Adjusting the Seat-Backs

⚠ WARNING

Reclining the seat-back too far can result in serious injury or death in a crash.

Adjust the seat-back to an upright position, and sit well back in the seat.

Do not put a cushion, or other object, between the seat-back and your back.

Doing so may interfere with proper seat belt or airbag operation.

If you cannot get far enough away from the steering wheel and still reach the controls, we recommend that you investigate whether some type of adaptive equipment may help.

FarmaSOS.com

■ Adjusting the Head Restraints

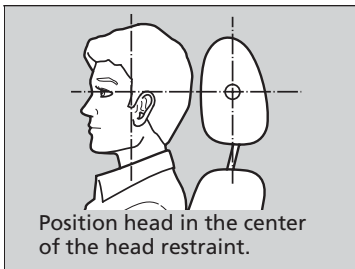

Your vehicle is equipped with head restraints in all seating positions.

Head restraints are most effective for protection against whiplash and other rear-impact crash injuries when the center of the back of the occupant's head rests against the center of the restraint. The tops of the occupant's ears should be level with the center height of the restraint.

► Adjusting the Head Restraints

⚠ WARNING

Improperly positioning head restraints reduces their effectiveness and increases the likelihood of serious injury in a crash.

Make sure head restraints are in place and positioned properly before driving.

In order for the head restraint system to work properly:

- Do not hang any items on the head restraints, or from the restraint legs.
- Do not place any object between an occupant and the seat-back.
- Install each restraint in its proper location.

■ Adjusting the front head restraint positions

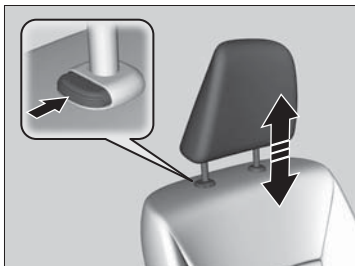

To raise the head restraint: Pull it upward.

To lower the head restraint: Push it down while pressing the release button.

FarmaSOS.com

■ Changing the Rear Center Seat Head Restraint Positions

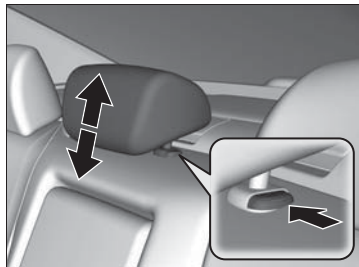

A passenger sitting in the center back seating position should adjust the height of their head restraint to an appropriate position before the vehicle begins moving.

To raise the head restraint:

Pull it upward.

To lower the head restraint:

Push it down while pressing the release button.

■ Removing and Reinstalling the Head Restraints

Head restraints can be removed for cleaning or repair.

To remove a head restraint:

Pull the restraint up as far as it will go. Then push the release button, and pull the restraint up and out.

To reinstall a head restraint:

Insert the legs back in place, then adjust the head restraint to an appropriate height while pressing the release button. Pull up on the restraint to make sure it is locked in position.

► Removing and Reinstalling the Head Restraints

⚠ WARNING

Failure to reinstall, or correctly reinstall, the head restraints can result in severe injury during a crash.

Always replace the head restraints before driving.

Maintain a Proper Sitting Position

After all occupants have adjusted their seats and head restraints, and put on their seat belts, it is very important that they continue to sit upright, well back in their seats, with their feet on the floor, until the vehicle is safely parked and the engine is off.

Sitting improperly can increase the chance of injury during a crash. For example, if an occupant slouches, lies down, turns sideways, sits forward, leans forward or sideways, or puts one or both feet up, the chance of injury during a crash is greatly increased.

In addition, an occupant who is out of position in the front seat can be seriously or fatally injured in a crash by striking interior parts of the vehicle or being struck by an inflating front airbag.

Maintain a Proper Sitting Position

⚠ WARNING

Sitting improperly or out of position can result in serious injury or death in a crash.

Always sit upright, well back in the seat, with your feet on the floor.

امداد خودرو فارما

تلفن شبانه روزی: ۰۲۱-۸۸۸۶۲۰۸۵

FarmaSOS.com

Rear Seats

Folding Down the Rear Seat

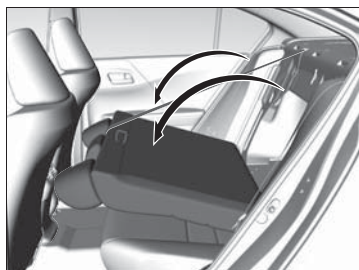
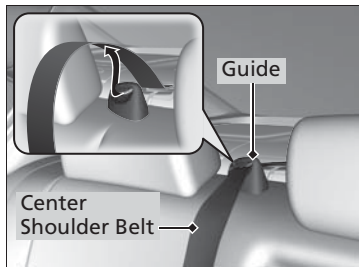

1. Remove the center shoulder belt from the guide.

2. Pull the release lever in the trunk to release the lock.

3. Fold the seat-back down.

If the rear head restraints get caught on the front seat-backs, remove the head restraints.

➤ **Removing and Reinstalling the Head Restraints** P. 152

Folding Down the Rear Seat

The rear seat-back can be folded down to accommodate bulkier items in the trunk.

Never drive with the seat-back folded down and the trunk lid open.

➤ **Exhaust Gas Hazard** P. 64

To lock a seat-back upright, push it backwards until it locks.

When returning the seat-back to its original position, push it firmly back. Also, make sure all rear shoulder belts are positioned in front of the seat-back, and the center shoulder belt is re-positioned in the guide.

Make sure that the folded seat-back does not press against the front passenger seat, as this can cause the weight sensors in the front passenger seat to work improperly.

➤ **Passenger Airbag Off Indicator** P. 50

Make sure all items in the trunk or items extending through the opening into the rear seat is properly secured. Loose items can fly forward if you have to brake hard.

The front seat(s) must be far enough forward so they do not interfere with the rear seats as they fold down.

Armrest

■ Using the Rear Seat Armrest

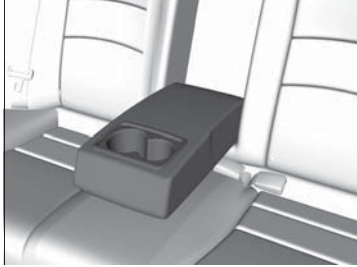

Pull down the armrest in the center seat-back.

امداد خودرو فارما

تلفن شبانه روزی: ۰۲۱-۸۸۸۶۲۰۸۵

FarmaSOS.com

Interior Lights

Interior Light Switches

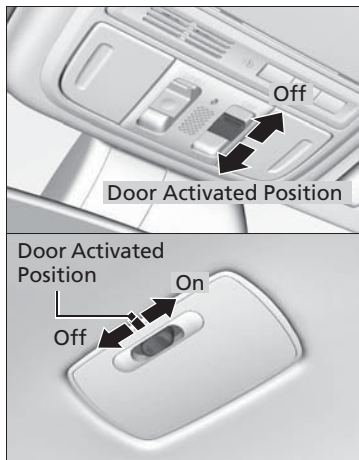

■ ON

The interior lights come on regardless of whether the doors are open or closed.

■ Door activated

The interior lights come on in the following situations:

- When any of the doors are opened.
- You unlock the driver's door.

Models without smart entry system

- You remove the key from the ignition switch.

Models with smart entry system

- When the power mode is set to VEHICLE OFF (LOCK).

■ OFF

The interior lights remain off regardless of whether the doors are open or closed.

Interior Light Switches

In the door activated position, the interior lights fade out and go off about 30 seconds after the doors are closed. The lights go off after 30 seconds in the following situations:

- When you unlock the driver's door but do not open it.

Models without smart entry system

- When you remove the key from the ignition switch but do not open a door.

Models with smart entry system

- When you set the power mode to VEHICLE OFF (LOCK) but do not open a door.

You can change the interior lights dimming time.

➤ **Customized Features** P. 97, 298

The interior lights go off immediately in the following situations:

- When you lock the driver's door.
- When you turn the ignition switch to ON **II***1.

Models without smart entry system

- When you close the driver's door with the key in the ignition switch.

Models with smart entry system

- When you close the driver's door in ACCESSORY mode.

If you leave any of the doors open without the key in the ignition switch*1, the interior lights go off after about 15 minutes.

*1: Models with the smart entry system have an **ENGINE START/STOP** button instead of an ignition switch.

Map Lights

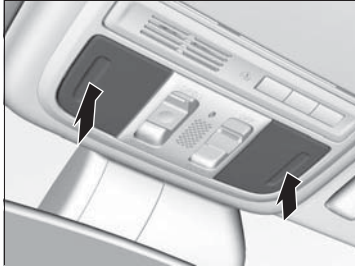

The map lights can be turned on and off by pressing the lenses.

Map Lights

When the ceiling light switch is in the door activated position and any door is open, the map light will not go off when you press the lens.

امداد خودرو فارما

تلفن شبانه روزی: ۰۲۱-۸۸۸۶۲۰۸۵

FarmaSOS.com

Interior Convenience Items

Glove Box

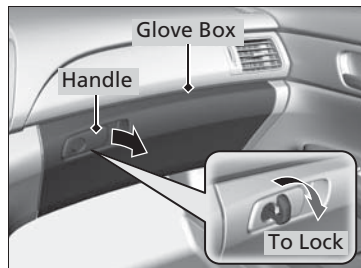

Pull the handle to open the glove box.

Models with smart entry system

You can lock the glove box with the built-in key.

Glove Box

⚠ WARNING

An open glove box can cause serious injury to your passenger in a crash, even if the passenger is wearing the seat belt.

Always keep the glove box closed while driving.

Console Compartment

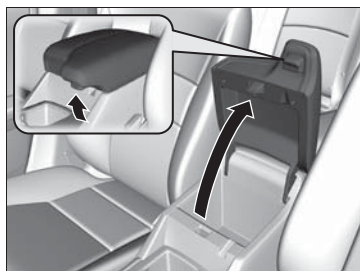

Pull the handle to open the console compartment.

امداد خودرو فارما

تلفن شبانه روزی: ۰۸۵-۱۸۸۶۲۰۸۵

FarmaSOS.com

Center Pocket*

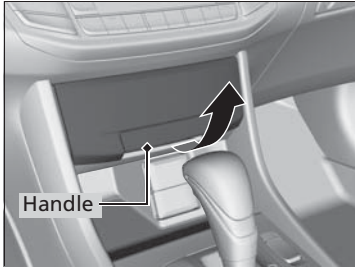

Pull the handle to open the pocket.

امداد خودرو فارما

تلفن شبانه روزی: ۰۲۱-۸۸۸۶۲۰۸۵

FarmaSOS.com

* Not available on all models

Beverage Holders

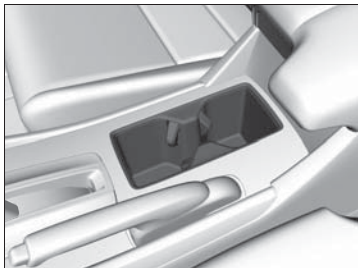

■ Front seat beverage holders

Are located in the console between the front seats.

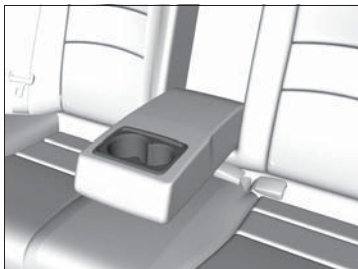

■ Rear seat beverage holders

Fold the armrest down to use the rear seat beverage holders.

» Beverage Holders

NOTICE

Spilled liquids damage the upholstery, carpeting, and electrical components in the interior.

Be careful when you are using the beverage holders. Hot liquid can scald you.

امداد خودرو فارما
تلفن شبانه روزی: ۰۲۱-۸۸۸۶۲۰۸۵

FarmaSOS.com

■ Accessory Power Sockets

The accessory power sockets can be used when the ignition switch is in ACCESSORY **I** or ON **II***1.

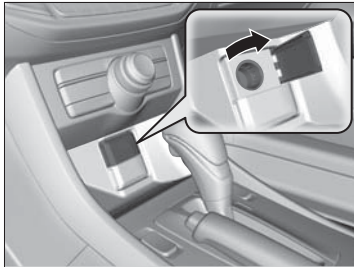

■ Accessory power socket (console panel)

Open the cover to use it.



■ Accessory power socket (console compartment)

Open the console lid and the cover to use it.

▣ Accessory Power Sockets

NOTICE

Do not insert an automotive type cigarette lighter element.

This can overheat the power socket.

The accessory power socket is designed to supply power for 12-volt DC accessories that are rated 180 watts (15 amps) or less.

To prevent battery drain, only use the power socket with the engine running.

When both sockets are being used, the combined power rating of the accessories should not exceed 180 watts (15 amps).

*1: Models with the smart entry system have an **ENGINE START/STOP** button instead of an ignition switch.

Coat Hook



There is a coat hook on the rear left grab handle. Pull it down to use it.

Coat Hook

The coat hook is not designed for large or heavy items.

Cargo Hooks

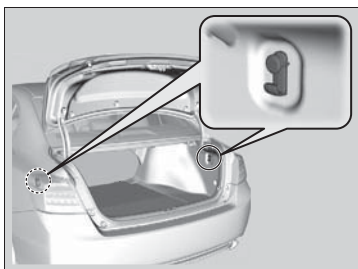

The cargo hooks in the trunk can be used to install a net for securing items.

Cargo Hooks

Heavy objects may damage the hook. Make sure any items put on this hook weigh less than 6.6 lbs (3 kg).

Distribute cargo evenly on the floor of the trunk, placing the heaviest items on the bottom and as far forward as possible.

► **Maximum Load Limit** P. 419

■ Sunglasses Holder

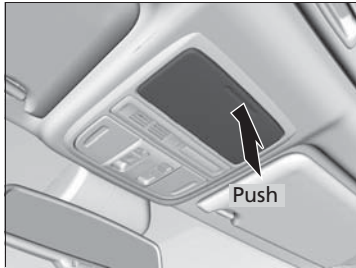

To open the sunglasses holder, push and release the indent. To close, push it again until it latches.

You can store eyeglasses and other small items in this holder.

امداد خودرو فارما

تلفن شبانه روزی: ۰۲۱-۸۸۸۶۲۰۸۵

FarmaSOS.com

☒ Sunglasses Holder

Keep the holder closed while driving except when accessing stored items.

Front Seat Heaters*

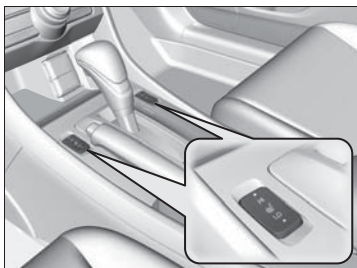

The ignition switch must be in ON **II***1 to use the seat heaters. The **HI** setting heats the seats faster than the **LO** setting.

While in **HI**, the heater cycles on and off.

- The appropriate indicator will be on while the seat heater is on. Briefly press the switch on the opposite side to turn the heater off. The indicator will be off. When a comfortable temperature is reached, select **LO** to keep the seat warm.

Front Seat Heaters*

⚠ WARNING

Heat induced burns are possible when using seat heaters.

Persons with a diminished ability to sense temperature (e.g., persons with diabetes, lower-limb nerve damage, or paralysis) or with sensitive skin should not use seat heaters.

Do not use the seat heaters even in **LO** when the engine is off. Under such conditions, the battery may be weakened, making the engine difficult to start.

In the **LO** setting, the heater runs continuously and does not automatically turn off.

*1: Models with the smart entry system have an **ENGINE START/STOP** button instead of an ignition switch.

Rear Seat Heaters*

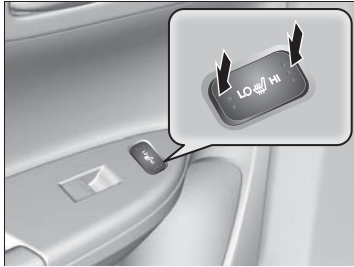

The ignition switch must be in ON **II***¹ to use the seat heaters. The **HI** setting heats the seats faster than the **LO** setting.

There is no heater in the rear center seating position.

While in **HI**, the heater cycles on and off.

- The appropriate indicator will be on while the seat heater is on. When a comfortable temperature is reached, select **LO** to keep the seat warm.

تلفن شبانه روزی: ۰۲۱-۸۸۶۲۰۸۵

FarmaSOS.com

▣ Rear Seat Heaters*

⚠ WARNING

Heat induced burns are possible when using seat heaters.

Persons with a diminished ability to sense temperature (e.g., persons with diabetes, lower-limb nerve damage, or paralysis) or with sensitive skin should not use seat heaters.

Do not use the seat heaters even in **LO** when the engine is off. Under such conditions, the battery may be weakened, making the engine difficult to start.

In the **LO** setting, the heater runs continuously and does not automatically turn off.

*1: Models with the smart entry system have an **ENGINE START/STOP** button instead of an ignition switch.

* Not available on all models

Using Vents, Heating and A/C

Mode Buttons

Change airflow.

Floor and defroster vents

Floor vents

Dashboard and floor vents

Dashboard vents

Fan Control Dial

Adjusts the fan speed. Rotate the dial all the way to **OFF** to turn everything off.

Windshield Defroster Button

Turns on the A/C, selects airflow from the defroster vents at the base of the windshield, and switches the mode to fresh air.

Temperature Control Dial

Adjusts the interior temperature.

MAX A/C Button

Turns on the A/C, selects airflow from the dashboard vents, and switches the mode to recirculation.

A/C Button

Press to cool the interior or dehumidify while heating.

(Recirculation) Button

Press the  button and switch the mode depending on environmental conditions.

Recirculation mode (indicator on):

Recirculates air from the vehicle's interior through the system.

Fresh air mode (indicator off):

Maintains outside ventilation. Keep the system in fresh air mode in normal situations.



■ Heating

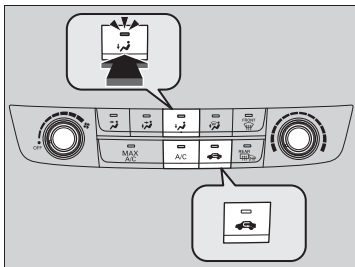

The heater uses engine coolant to warm the air.



1. Adjust the fan speed using the fan control dial.
2. Select .
3. Adjust the temperature using the temperature control dial.

▶▶ Heating

When you select , the mode automatically switches to fresh air.

▶▶ To rapidly warm up the interior

■ To rapidly warm up the interior

1. Set the fan to the maximum speed.
2. Select .
3. Set the temperature to maximum warm.
4. Press the  button (the indicator on).

■ To dehumidify the interior

When used in combination with the heater, the air conditioning system makes the interior warm and dry and can prevent the windows from fogging up.

1. Turn the fan on.
2. Press the **A/C** button to turn on the air conditioning.

Change to fresh air mode as soon as the interior gets warm enough. The windows may fog up if kept in recirculation mode.

Cooling

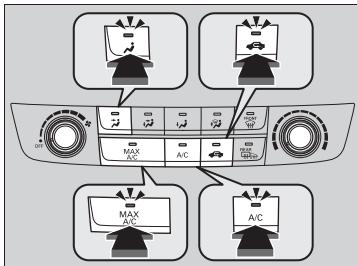

1. Adjust the fan speed using the fan control dial.
2. Select .
3. Adjust the temperature using the temperature control dial.
4. Press the **A/C** button (the indicator on).

To rapidly cool down the interior

1. Set the fan to the maximum speed.
2. Set the temperature to maximum cool.
3. Press the  button (the indicator on).

To rapidly cool down the interior

If the interior is very warm, you can cool it down more rapidly by partially opening the windows.

While in the ECON mode, the system has greater temperature fluctuations.

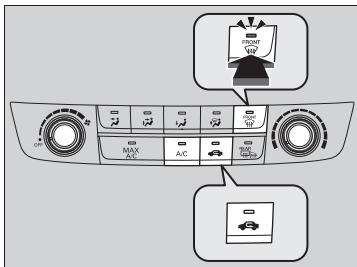

Pressing the  button bypasses the ECON mode control, and cools down the interior more rapidly.

Defrosting the Windshield and Windows



Pressing the  button turns the air conditioning system on and automatically switches the system to fresh air mode.

To rapidly defrost the windows

1. Set the fan to the maximum speed.
2. Press the  button.
3. Press the  button.
4. Set the temperature to maximum warm.

Defrosting the Windshield and Windows

For your safety, make sure you have a clear view through all the windows before driving.

Do not set the temperature near the upper or lower limit.

When cold air hits the windshield, the outside of the windshield may fog up.

If the side windows fog up, adjust the vents so that the air hits the side windows.

To rapidly defrost the windows

After defrosting the windows, switch over to fresh air mode.

If you keep the system in recirculation mode, the windows may fog up from humidity. This impedes visibility.

Using Automatic Climate Control

The automatic climate control system maintains the interior temperature you select. The system also selects the proper mix of heated or cooled air that raises or lowers the interior temperature to your preference as quickly as possible.

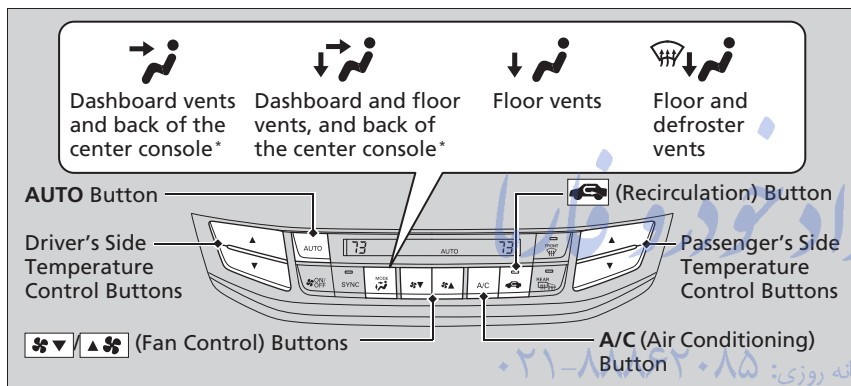

Use the system when the engine is running.

1. Press the **AUTO** button.
2. Adjust the interior temperature using the driver's side or passenger's side control buttons.
3. Press the **ON/OFF** (on/off) button to cancel.

■ Switching between the recirculation and fresh air modes

Press the  (recirculation) button and switch the mode depending on environmental conditions.

Recirculation mode (indicator on): Recirculates air from the vehicle's interior through the system.

Fresh air mode (indicator off): Maintains outside ventilation. Keep the system in fresh air mode in normal situations.

* Not available on all models

■ Using Automatic Climate Control

If any buttons are pressed while using the climate control system in auto, the function of the button that was pressed will take priority. The **AUTO** indicator will go off, but functions unrelated to the button that was pressed will be controlled automatically.

To prevent cold air from blowing in from outside, the fan may not start immediately when the **AUTO** button is pressed.

If the interior is very warm, you can cool it down more rapidly by partially opening the windows, turning the system on auto, and setting the temperature to low. Change the fresh mode to recirculation mode until the temperature cools down.

When you set the temperature to the lower or upper limit, **Lo** or **Hi** is displayed.

Pressing the  button switches the climate control system between on and off. When turned on, the system returns to your last selection.

■ Defrosting the Windshield and Windows

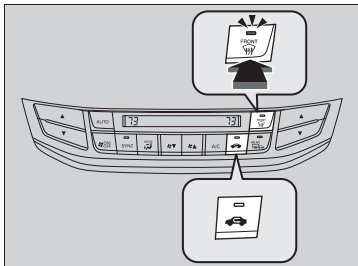

Pressing the  button turns the air conditioning system on and automatically switches the system to fresh air mode.

Press the  button again to turn off, the system returns to the previous settings.

■ To rapidly defrost the windows

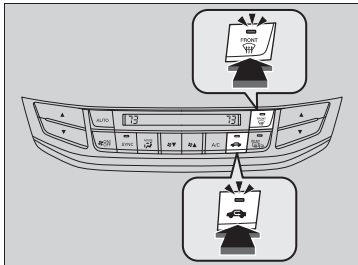

1. Press the  button.
2. Press the  button.

►► Defrosting the Windshield and Windows

For your safety, make sure you have a clear view through all the windows before driving.

Do not set the temperature near the upper or lower limit.

When cold air hits the windshield, the outside of the windshield may fog up.

If the side windows fog up, adjust the vents so that the air hits the side windows.

►► To rapidly defrost the windows

After defrosting the windows, switch over to fresh air mode. If you keep the system in recirculation mode, the windows may fog up from humidity. This impedes visibility.

امداد خودرو فارما

تلفن شبانه روزی: ۰۲۱-۸۸۸۶۲۰۸۵

FarmaSOS.com

Synchronized Mode

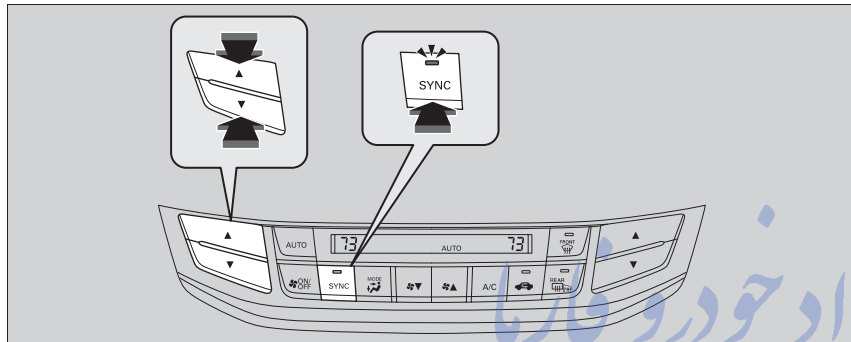

You can set the temperature synchronously for the driver side and the passenger side in synchronized mode.

1. Press the **SYNC** button.
▶ The system will switch to the synchronized mode.
2. Adjust the temperature using driver's side temperature control buttons.

Press the **SYNC** button to return to dual mode.

▶ Synchronized Mode

When you press the  button, the system changes to synchronized mode.

When the system is in dual mode, the driver side temperature and the passenger side temperature can be set separately.

Models with navigation system

The system adjusts each temperature based on the information of the sunlight sensor and the sun position updated by the navigation system's GPS.

تلفن شبانه روزی: ۰۲۱-۸۸۸۶۲۰۸۵

FarmaSOS.com

Automatic Climate Control Sensors

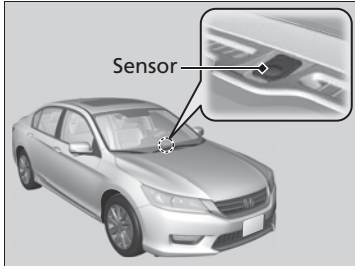

The automatic climate control system is equipped with sensors. Do not cover or spill any liquid on them.

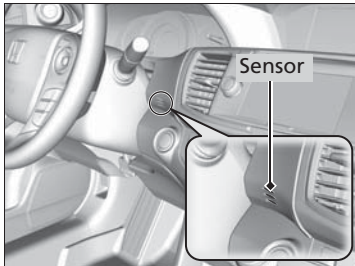

امداد خودرو فارما

تلفن شبانه روزی: ۰۲۱-۸۸۸۶۲۰۸۵

FarmaSOS.com

Features

This chapter describes how to operate technology features.

ایراد خودرو فارما

تلفن شبانه روزی: ۰۲۱-۸۸۸۶۲۰۸۵

Audio System

USB Port	175
Auxiliary Input Jack	176
Audio System Theft Protection*	177
Region Setting	178
Audio Remote Controls	179

Models with one display

Audio System Basic Operation	180
Audio/Information Screen	181
Display Setup	186
Playing AM/FM Radio	187
Playing a CD	189
Playing an iPod	192
Playing Internet Radio	195
Playing a USB Flash Drive	197
Playing <i>Bluetooth</i> ® Audio	200

Models with two displays

Audio System Basic Operation	202
Audio with Touch Screen	203
Audio/Information Screen	206
Display Setup	212
Playing AM/FM Radio	213
Playing SiriusXM® Radio*	217
Playing a CD	220
Playing an iPod	223
Playing Internet Radio	227
Playing a USB Flash Drive	230
Playing <i>Bluetooth</i> ® Audio	233

Models with navigation system

Audio System Basic Operation	235
Audio with Touch Screen	236
Audio/Information Screen	238

Display Setup	243
Voice Control Operation	244
Playing AM/FM Radio	252
Playing SiriusXM® Radio	256
Playing a CD	259
Playing Hard Disk Drive (HDD) Audio	262
Playing an iPod	272
Playing Internet Radio	280
Playing a USB Flash Drive	283
Playing <i>Bluetooth</i> ® Audio	286
Audio Error Messages	288
General Information on the Audio System	294
Customized Features	298
HomeLink® Universal Transceiver*	336
<i>Bluetooth</i>® HandsFreeLink®	338, 375
Compass*	413

* Not available on all models

About Your Audio System

Models with navigation system

See the Navigation System Manual for information on the navigation system.

The audio system features AM/FM radio and SiriusXM® Radio service*. It can also play audio CDs, WMA/MP3/AAC files, Hard Disk Drive (HDD) audio*, USB flash drives, and iPod, iPhone and *Bluetooth*® devices.

You can operate the audio system from the buttons and switches on the panel or the icons on the touchscreen interface*.

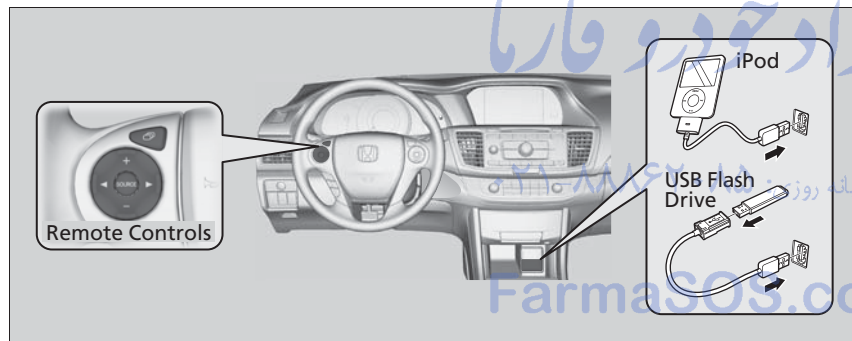

About Your Audio System

SiriusXM® Radio is available on a subscription basis only. For more information on SiriusXM® Radio, contact a dealer.

General Information on the Audio System P. 294

SiriusXM® Radio is available in the United States and Canada, except Hawaii, Alaska, and Puerto Rico.

SiriusXM® is a trademark of Sirius XM Radio, Inc.

Video CDs, DVDs, and 3-inch (8-cm) mini CDs are not supported.

iPod, iPhone and iTunes are trademarks of Apple Inc.

State or local laws may prohibit the operation of handheld electronic devices while operating a vehicle.

USB Port

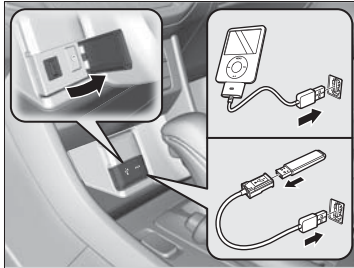

Install the iPod dock connector or the USB flash drive to the USB port.

USB Port

- Do not leave the iPod or USB flash drive in the vehicle. Direct sunlight and high temperatures may damage it.
- We recommend using an extension cable with the USB port.
- Do not connect the iPod or USB flash drive using a hub.
- Do not use a device such as a card reader or hard disk drive, as the device or your files may be damaged.
- We recommend backing up your data before using the device in your vehicle.
- Displayed messages may vary depending on the device model and software version.

If the audio system does not recognize the iPod, try reconnecting it a few times or reboot the device. To reboot, follow the manufacturer's instructions provided with the iPod or visit www.apple.com/ipod.

امداد خودرو فارما

تلفن شبانه روزی: ۰۲۱-۸۸۸۶۲۰۸۵

FarmaSOS.com

Auxiliary Input Jack

Use the jack to connect standard audio devices.

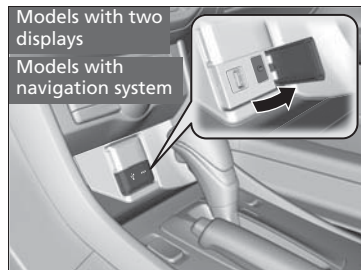
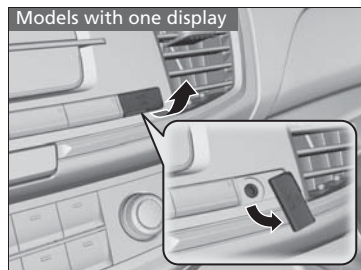

1. Open the **AUX** cover.
2. Connect a standard audio device to the input jack using a 1/8 inch (3.5 mm) stereo miniplug.
 - ▶ The audio system automatically switches to the AUX mode.

▶▶ Auxiliary Input Jack

Models with one display

You can return to AUX mode by pressing the **AUX** button.

Models with two displays

Models with navigation system

You can return to AUX mode by selecting **Change Source** on the **Audio menu** screen or **Source** on the touchscreen.

Replacement of the audio system with other than a genuine Honda system may make the auxiliary jack inoperable.

امداد خودرو فارما

تلفن شبانه روزی: ۰۲۱-۸۸۸۶۲۰۸۵

FarmaSOS.com

Audio System Theft Protection *

The audio system is disabled when it is disconnected from the power source, such as when the 12-volt battery is disconnected or goes dead.

■ Reactivating the audio system

1. Set the power mode to ON, and turn on the audio system.
 - ▶ If you set the power mode to ACCESSORY, you will be requested to enter the audio security code. See step 3.
2. Press and hold the power button again for more than two seconds.
 - ▶ The audio system is reactivated when the system's control unit recognizes that the system is in your vehicle.
 - If the control unit fails to recognize, **Enter PIN Code** appears on the audio/information screen.
3. If the two steps do not work, you can enter the audio security code using the touch screen. If you enter an incorrect digit, continue to the last digit, then try again. If you do not enter code correctly after 10 tries, leave the system for one hour before trying again, or visit a dealer to have the system reset.

▶▶ Audio System Theft Protection *

Find the audio system's security code and serial number label in your owner's manual kit.

We recommend that you write down the serial number in this owner's manual.

Do not store the label in your vehicle. If you lose the label, you must first retrieve the serial number, and then obtain the code.

You can find out about your serial number and security code from a dealer.

U.S. models

You can register the security code at Honda Owners (owners.honda.com), and find information on how to retrieve the serial number and obtain the code at radio-navicode.honda.com.

FarmaSOS.com





* Not available on all models

Models with two displays

Region Setting

The audio system's region setting may be lost when the battery is disconnected or goes dead.

If the **Region Select** screen appears, you need to set the region for the audio system. Follow the steps below:

1. Press  to select **OK**.
2. Rotate  to select the region you live in, then press .
3. You will receive a confirmation message on the screen. Rotate  to select **Yes**, then press .

Region Setting

The region setting is required only when the battery power is temporarily disconnected. It has been usually set to your vehicle's region type beforehand.

You cannot change the setting once you have completed the setting procedure. Contact a dealer if you selected an incorrect region.

امداد خودرو فارما

تلفن شبانه روزی: ۰۲۱-۸۸۸۶۲۰۸۵

FarmaSOS.com

Audio Remote Controls

Allow you to operate the audio system while driving.

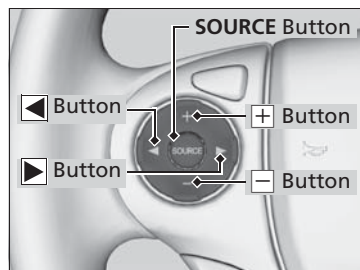

SOURCE Button

Cycles through the audio modes as follows:
 FM→AM→SiriusXM®*→CD→HDD*→USB→
 iPod→Bluetooth® Audio→Pandora®*→Aha™*
 →AUX

+ - (Volume) Buttons

Press **+**: To increase the volume.

Press **-**: To decrease the volume.

◀ ▶ Buttons

- When listening to the radio
 - Press **▶**: To select the next preset radio station.
 - Press **◀**: To select the previous preset radio station.
 - Press and hold **▶**: To select the next strong station.
 - Press and hold **◀**: To select the previous strong station.
- When listening to a CD, HDD*, iPod, USB flash drive, or Bluetooth® Audio
 - Press **▶**: To skip to the next song.
 - Press **◀**: To go back to the beginning of the current or previous song.
- When listening to a CD, HDD* or USB flash drive
 - Press and hold **▶**: To skip to the next folder.
 - Press and hold **◀**: To go back to the previous folder.
- When listening to Pandora®* or Aha™*
 - Press **▶**: To skip to the next song.
 - Press and hold **▶**: To select the next station.
 - Press and hold **◀**: To select the previous station.

▶▶ Audio Remote Controls

Some mode appears only when an appropriate device or medium is used.



امداد خودرو فارما

تلفن شبانه روزی: ۰۲۱-۸۸۶۲۰۸۵

FarmaSOS.com

* Not available on all models

Models with one display

To use the audio system function, the ignition switch must be in ACCESSORY  or ON *1.

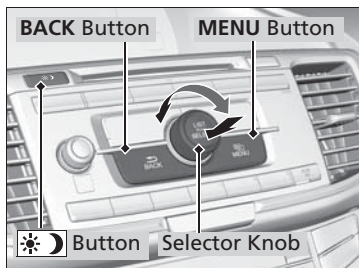

Use the selector knob or **MENU** button to access some audio functions.

Press  to switch between the normal and extended display for some functions.

Selector knob: Rotate left or right to scroll through the available choices. Press to set your selection.

MENU button: Press to select any mode. The available mode includes **Change Source**, **Station List**, **Save Preset**, **Radio Text**, **Music Search**, and play modes. Play modes can be also selected from **Scan**, **Random/Repeat**, and so on.

BACK button: Press to go back to the previous display.

 **button:** Press to change the audio/information screen brightness.

Press  once and make an adjustment.

- ▶ Each time you press , the mode switches between the daytime mode, nighttime mode and **OFF** mode.

Audio System Basic Operation

These indications are used to show how to operate the selector knob.

Rotate  to select.

Press  to enter.

Audio Menu Items

- ▶ **Station List** P. 188
- ▶ **Radio text** P. 188
- ▶ **Music Search** P. 190, 193, 198
- ▶ **Scan** P. 188, 191, 199
- ▶ **Random/Repeat** P. 191, 194, 199

This product includes software codes licensed under the conditions stated by the copyright holder.

For license conditions and the copy of the corresponding source code, visit: <http://www.hondaopensource1.com/001>

*1: Models with the smart entry system have an **ENGINE START/STOP** button instead of an ignition switch.

Audio/Information Screen

Displays the audio status and wallpaper. From this screen, you can go to various setup options.

Switching the Display

Press the  (display) button to change the display.



Features

■ Audio

Shows the current audio information.

■ Trip computer (Current Drive)

Shows the range, and instant and average fuel economy of the current trip, as well as the average fuel economy from your last trip.

■ Trip computer (History of Trip A)

Shows the range, average fuel economy and distance traveled for the current trip, as well as the average fuel economy and distances traveled during the last three driving cycles.

Each time you reset the trip meter A, the information on the display updates. The history of the previous three driving cycles is kept.

■ Clock/Wallpaper

Shows a clock screen or an image you import.

تلفن شبانه روزی: ۰۲۱-۸۸۸۶۲۰۸۵

FarmaSOS.com

Wallpaper Setup

You can change, store, and delete the wallpaper on the audio/information screen.



Import wallpaper

You can import up to three images, one at a time, for wallpaper from a USB flash drive.





1. Connect the USB flash drive to the USB port.

▶ **USB Port** P. 175

2. Press the **SETTINGS** button.
3. Rotate  to select **System Settings**, then press .

▶ Repeat the procedure to select **Clock, Clock/Wallpaper Type**, then **Wallpaper**.

4. Rotate  to select **Add New Wallpaper**, then press .
 - ▶ The preview of the imported data is displayed.







5. Rotate  to select a desired picture.
 - ▶ The preview is displayed on the left side on the screen.

6. Press  to save the data.
 - ▶ The confirmation message will appear. Then the display will return to the wallpaper list.









Wallpaper Setup

- When importing wallpaper files, the image must be in the USB flash drive's root directory. Images in a folder cannot be imported.
- The file name must be fewer than 64 characters.
- The file format of the image that can be imported is BMP (bmp) or JPEG (jpg).
- The individual file size limit is 2 MB.
- The maximum image size is 1,680 x 936 pixels. If the image size is less than 420 x 234 pixels, the image is displayed in the middle of the screen with the extra area appearing in black.
- Up to 255 files can be selected.
- If the USB flash drive does not have any pictures, the **No files detected** message appears.



■ Select wallpaper

1. Press the **SETTINGS** button.
2. Rotate  to select **System Settings**, then press .
 - ▶ Repeat the procedure to select **Clock, Clock/Wallpaper Type**, then **Wallpaper**.
 - ▶ The screen changes to the wallpaper list.
3. Rotate  to select a desired wallpaper, then press .
 - ▶ The pop-up menu appears on the screen.
4. Rotate  to select **Set**, then press .

■ Delete wallpaper

1. Press the **SETTINGS** button.
2. Rotate  to select **System Settings**, then press .
 - ▶ Repeat the procedure to select **Clock, Clock/Wallpaper Type**, then **Wallpaper**.
 - ▶ The screen changes to the wallpaper list.
3. Rotate  to select a wallpaper that you want to delete, then press .
 - ▶ The pop-up menu appears on the screen.
4. Rotate  to select **Delete**, then press .
 - ▶ The confirmation message will appear.
5. Rotate  to select **OK**, then press  to delete completely.

▶▶ Wallpaper Setup

From the pop-up menu, rotate  to select **Preview** and press  to see a preview at full-size screen.

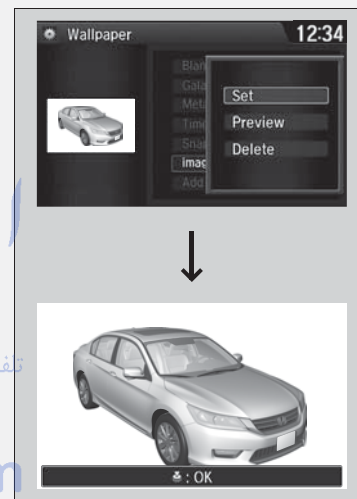

To go back to the previous screen, press  to select **OK**, or press the **BACK** button.

When the file size is large, it takes a while to be previewed.

Adjusting the Sound

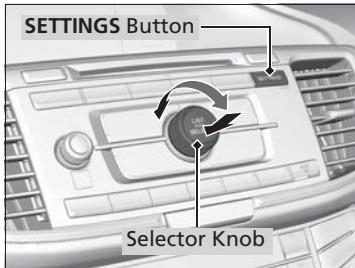

1. Press the **SETTINGS** button.
2. Rotate to select **Audio Settings**, then press .
3. Rotate to select **Sound**, then press .

Rotate to scroll through the following choices:

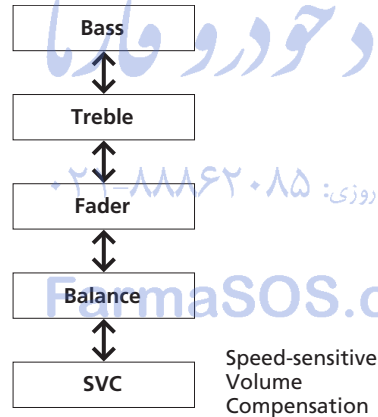

Adjusting the Sound

The SVC has four modes: **Off**, **Low**, **Mid**, and **High**. SVC adjusts the volume level based on the vehicle speed. As you go faster, audio volume increases. As you slow down, audio volume decreases.

Display Setup

You can change the brightness or color theme of the audio/information screen.

Changing the Screen Brightness

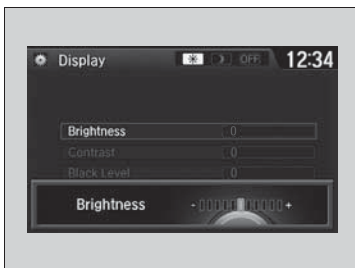

1. Press the **SETTINGS** button.
2. Rotate to select **System Settings**, then press .
- ▶ Repeat the procedure to select **Display**.
3. Rotate to select **Brightness**, then press .
4. Rotate to adjust the setting, then press .

Changing the Screen Brightness

You can change the **Contrast** and **Black Level** settings in the same manner.

Changing the Screen's Color Theme

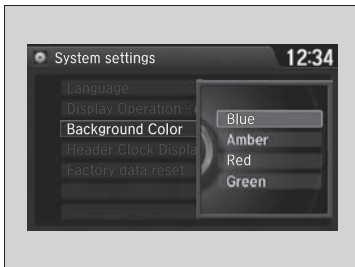

1. Press the **SETTINGS** button.
2. Rotate to select **System Settings**, then press .
- ▶ Repeat the procedure to select **Other**.
3. Rotate to select **Background Color**, then press .
4. Rotate to select the setting you want, then press .

Playing AM/FM Radio

Audio/Information Screen



FM/AM Button

Press to select a band.

VOL/⏻ (Power/volume) Knob

Press to turn the audio system on and off.
Turn to adjust the volume.

BACK Button

Press to go back to the previous display or cancel a setting.

Preset Buttons (1-6)

To store a station:
Tune to the selected station.
Pick a preset button and hold it until you hear a beep.
To listen to a stored station, select a band, then press the preset button.

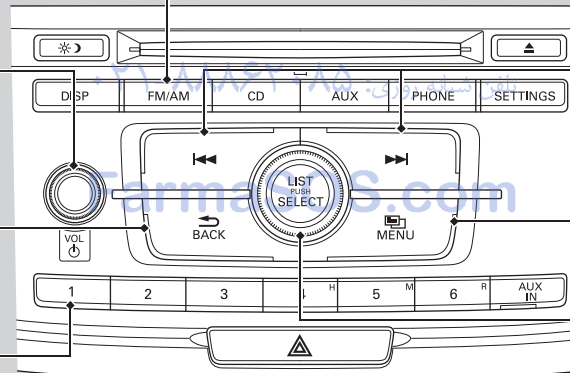

Seek/Skip Buttons

Press ◀◀ and ▶▶ to search up and down the selected band for a station with a strong signal.

MENU Button

Press to display the menu items.



Selector Knob

Turn to tune the radio frequency.
Press and turn to select an item, then press to set your selection.

Radio Data System (RDS)

Provides text data information related to your selected RDS-capable FM station.

To find an RDS station from Station List

1. Press  while listening to an FM station.
2. Rotate  to select the station, then press .

Manual update

Updates your available station list at any time.

1. Press  while listening to an FM station.
2. Rotate  to select **Refresh**, then press .

Radio text

Displays the radio text information of the selected RDS station.

1. Press the **MENU** button.
2. Rotate  to select **Radio Text**, then press .

Scan

Samples each of the strongest stations on the selected band for 10 seconds.

1. Press the **MENU** button.
2. Rotate  to select **Scan**, then press .

To turn off scan, press  to select **Stop**, or press the **BACK** button.

▶▶ Playing AM/FM Radio

The **ST** indicator appears on the display indicating stereo FM broadcasts. Stereo reproduction in AM is not available.

Switching the Audio Mode

Press the **SOURCE** button on the steering wheel.

▶▶ Audio Remote Controls P. 179

You can also switch the mode by pressing the **MENU** button and selecting **Change Source** on the MENU screen.

You can store 6 AM stations and 12 FM stations into the preset memory.

▶▶ Radio Data System (RDS)

When you select an RDS-capable FM station, the RDS automatically turns on, and the frequency display changes to the station name. However, when the signals of that station become weak, the display changes from the station name to the frequency.

Playing a CD

Your audio system supports audio CDs, CD-Rs and CD-RWs in either MP3, WMA, or AAC*1 format. With the CD loaded, press the **CD** button.

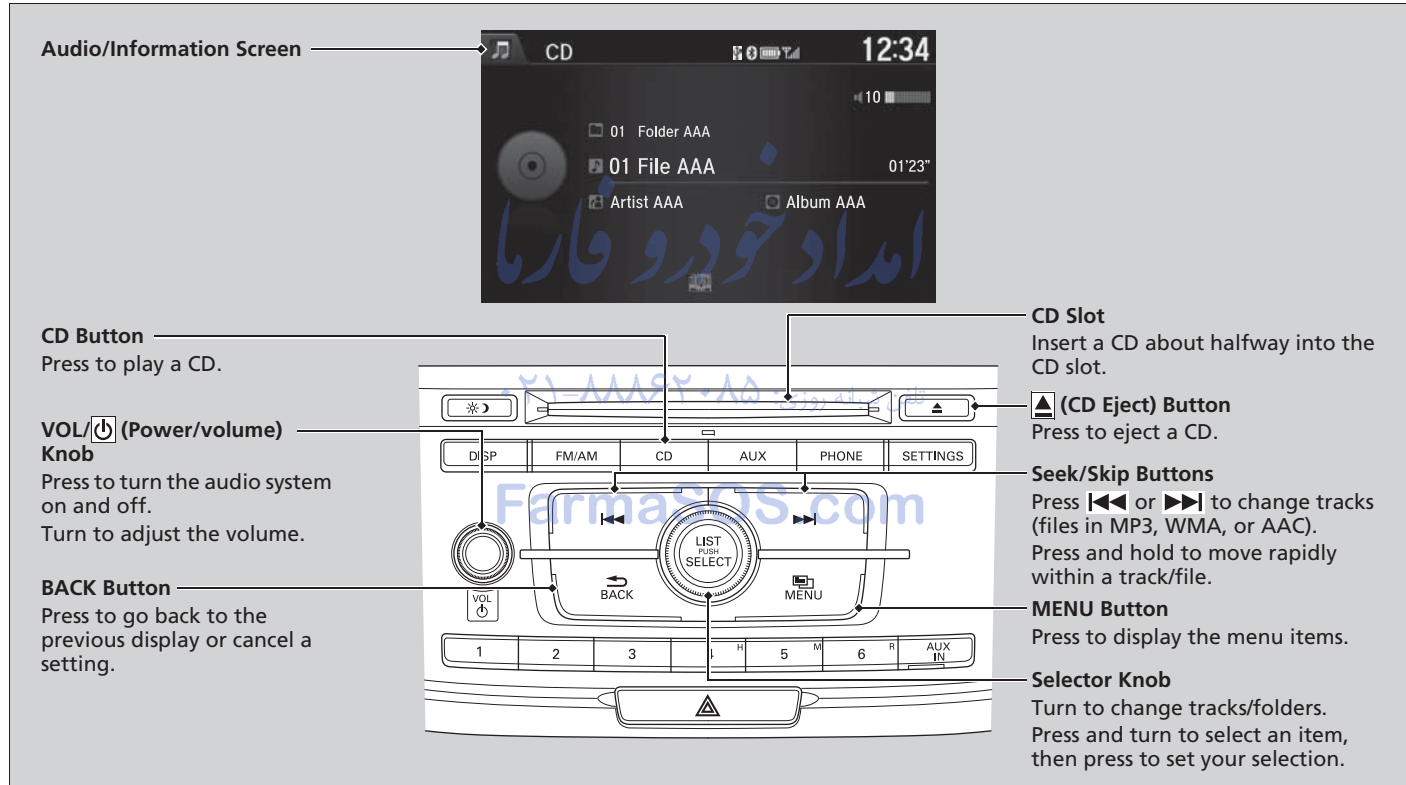

*1: Only AAC format files recorded with iTunes are playable on this unit.

How to Select a File from the Music Search List (MP3/WMA/AAC)

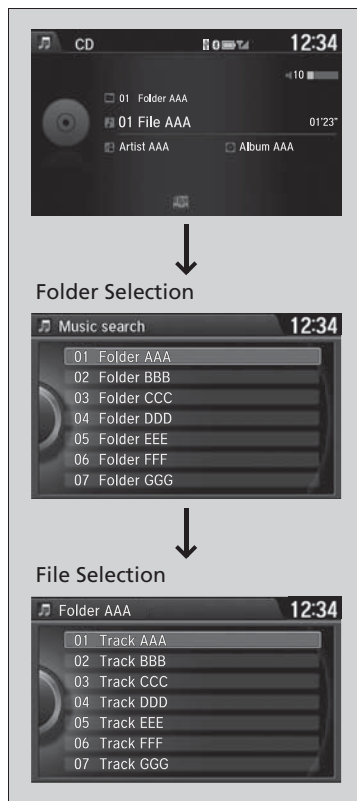

1. Press the **MENU** button.
2. Rotate to select **Music Search**, then press .
3. Rotate to select a folder.
4. Press to change the display to a list of files in that folder.
5. Rotate to select a file, then press .

▶▶ Playing a CD

NOTICE

Do not use CDs with adhesive labels. The label can cause the CD to jam in the unit.

WMA files protected by digital rights management (DRM) cannot be played.

The audio system displays **Unplayable File**, then skips to the next file.

Text data appears on the display under the following circumstances:

- When you select a new folder, file, or track.
- When you change the audio mode to CD.
- When you insert a CD.

If you eject the CD but do not remove it from the slot, the system reloads the CD automatically after several seconds.

How to Select a Play Mode

You can select scan, repeat, and random modes when playing a track or file.

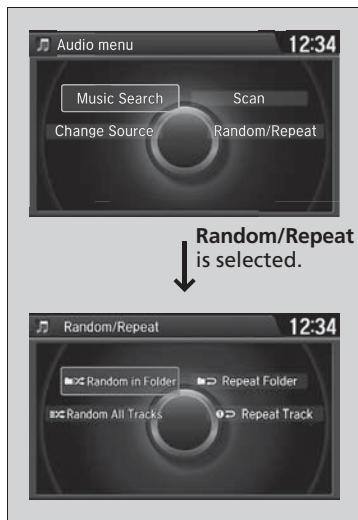

1. Press the **MENU** button.
2. Rotate to select **Scan** or **Random/Repeat**, then press .
3. Rotate to select a mode, then press .

To turn off a play mode

1. Press the **MENU** button.
2. Rotate to select the mode you want to turn off, then press .

How to Select a Play Mode

Play Mode Menu Items

Scan

Scan Folders (MP3/WMA/AAC): Provides 10-second sampling of the first file in each of the main folders.

Scan Tracks: Provides 10-second sampling of all tracks on the CD (all files in the current folder in MP3, WMA, or AAC).

Random/Repeat

Repeat Folder (MP3/WMA/AAC): Repeats all files in the current folder.

Repeat Track: Repeats the current track/file.

Random in Folder (MP3/WMA/AAC): Plays all files in the current folder in random order.

Random All Tracks: Plays all tracks/files in random order.

امداد خودرو فارما

تلفن شبانه روزی: ۰۲۱-۸۸۸۶۲۰۸۵

FarmaSOS.com

Playing an iPod

Connect the iPod using your dock connector to the USB Port, then press the **AUX** button.

📖 **USB Port** P. 175

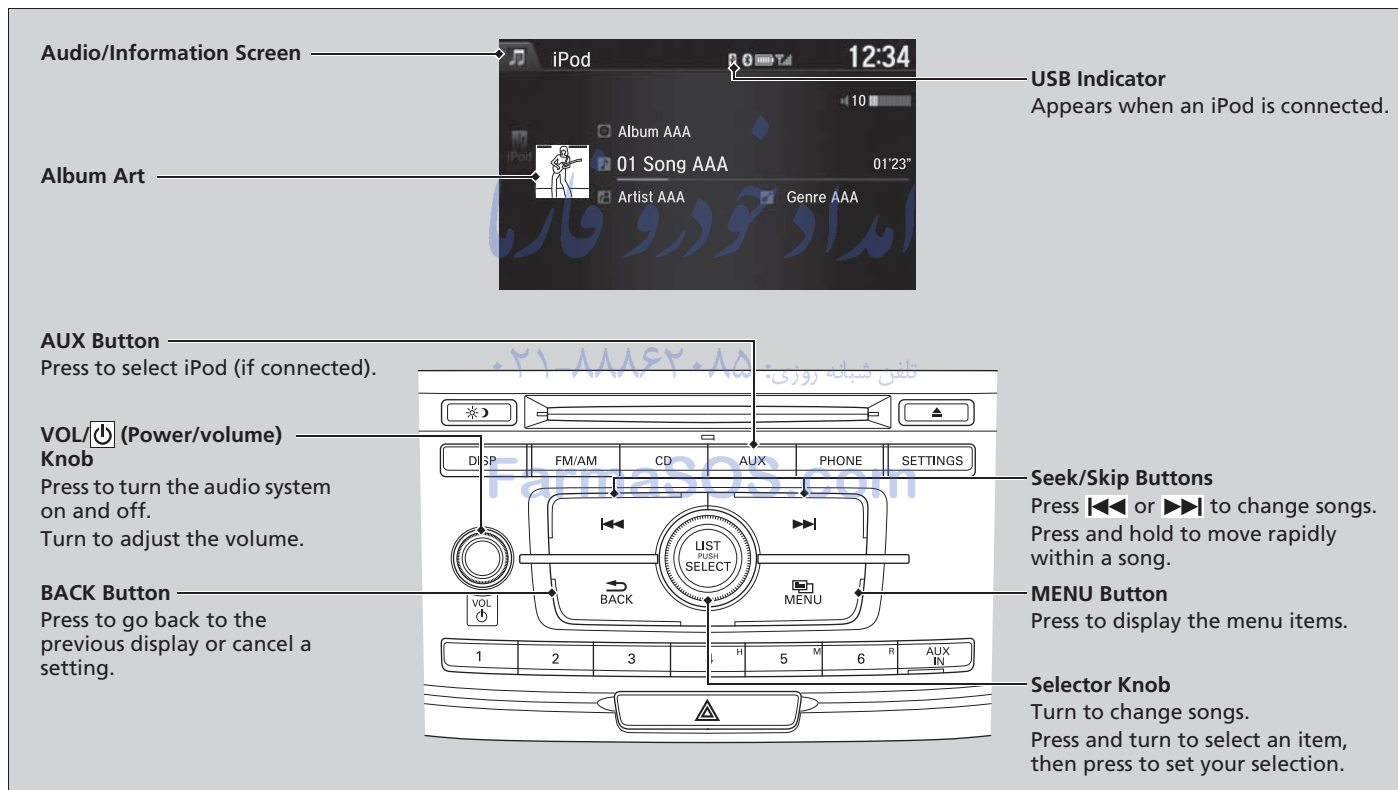

How to Select a Song from the Music Search List

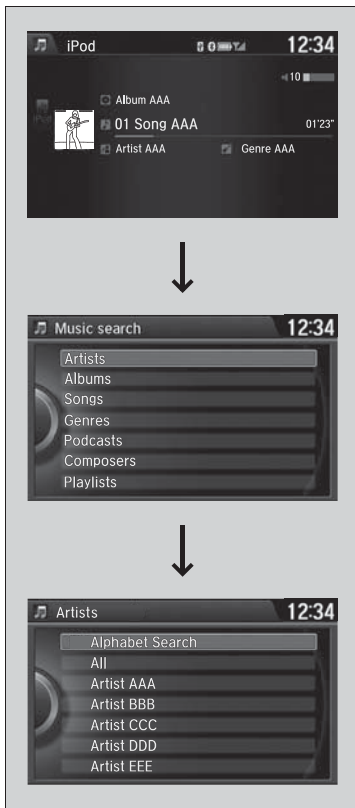

1. Press the **MENU** button.
2. Rotate to select **Music Search**, then press .
3. Rotate to select a menu.
4. Press to display the items on that menu.
5. Rotate to select an item, then press .

امداد خودرو فارما

تلفن شبانه روزی: ۰۲۱-۸۸۸۶۲۰۸۵

FarmaSOS.com

▶▶ Playing an iPod

Available operating functions vary on models or versions. Some functions may not be available on the vehicle's audio system.





If there is a problem, you may see an error message on the audio/information screen.

▶ **iPod/USB Flash Drive** P. 290

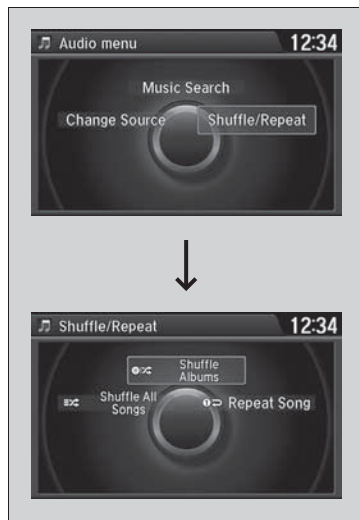
How to Select a Play Mode

You can select repeat and shuffle modes when playing a file.



1. Press the **MENU** button.
2. Rotate  to select **Shuffle/Repeat**, then press .
3. Rotate  to select a mode, then press .

How to Select a Play Mode

Play Mode Menu Items

Repeat Song: Repeats the current file.

Shuffle Album: Plays all available albums in a selected list (playlists, artists, albums, songs, genres, or composers) in random order.



Shuffle All Songs: Plays all available files in a selected list (playlists, artists, albums, songs, genres, or composers) in random order.

امداد خودرو فارما

تلفن شبانه روزی: ۰۲۱-۸۸۸۶۲۰۸۵

FarmaSOS.com

To turn off a play mode

1. Press the **MENU** button.
2. Rotate  to select the mode you want to turn off, then press .

U.S. models

Compatible phones only

Playing Internet Radio

Connect a compatible phone through *Bluetooth*®.

iPhone

You can also connect the phone using your dock connector to the USB port. Press the **AUX** button to select Pandora mode.

▶▶ Playing Internet Radio

Pandora®, the Pandora logo, and the Pandora trade dress are trademarks or registered trademarks of Pandora Media, Inc., used with permission. Pandora is currently available exclusively in the United States.

To find out if your phone is compatible with this feature, visit www.handsfreelink.honda.com, or call 1-888-528-7876.

To use this service in your vehicle, the Pandora® app must first be installed on your phone. Visit www.pandora.com for more information.

Audio/Information Screen —

USB Indicator
Appears when a phone is connected.

Rating Icon

Selector Knob
Turn to switch to another station.

VOL/⏻ (Volume/Power) Knob
Press to turn the audio system on and off.
Turn to adjust the volume.

BACK Button
Press to go back to the previous display.

Preset Button (1)
Press to switch the mode between pause and resume.

Preset Button (2)
Press to select **Dislike**.

AUX Button
Press to select Pandora®.

Skip Button
Press ►► to skip a song.

MENU Button
Press to display the menu items.

Preset Button (5)
Press to select **Bookmark Artist**.

Preset Button (4)
Press to select **Bookmark Track**.

Preset Button (3)
Press to select **Like**.

Continued

Features



■ Pandora® Menu

You can operate some of the Pandora® menu items from your vehicle's audio system. The available items are:

- **Like** (Thumbs-up)
- **Dislike** (Thumbs-down)
- **Station List**
- **Change Source**
- **Bookmark Track**
- **Bookmark Artist**
- **Play/Pause**

■ Operating a menu item



1. Press the **MENU** button.
2. Rotate  to select an item, then press .

▶▶ Playing Internet Radio

Pandora® is free, personalized radio that plays music and comedy you'll love. Just start with the name of one of your favorite artists, songs, comedians or composers and Pandora® will create a custom station that plays similar tracks. Pandora® also features hundreds of genre stations ranging from Dubstep to Smooth Jazz to Power Workout.

If you cannot operate Pandora® through the audio system, it may be streaming through *Bluetooth®* Audio. Make sure Pandora® mode on your audio system is selected.

Changing Stations

To change stations, activate the Pandora® menu, select **Station List**, and then select a new station.

▶▶ Pandora® Menu

Available operating functions vary on software versions. Some functions may not be available on the vehicle's audio system.

If there is a problem, you may see an error message on the audio/information screen.

 **Pandora®** P. 291

Pandora® may limit the total number of skips allowed on the service. If you dislike a track after the skip limit has been reached, your feedback will be saved but the current track will continue to play.

Playing a USB Flash Drive

Your audio system reads and plays sound files on a USB flash drive in either MP3, WMA or AAC*1 format.

Connect your USB flash drive to the USB port, then press the **AUX** button.

▶ **USB Port** P. 175

The diagram illustrates the audio system's interface for playing a USB flash drive. It is divided into two main sections: a digital display screen and a physical control panel.

Audio/Information Screen: The top screen shows a music player interface with the title 'USB' and a time of 12:34. It lists '01 Folder AAA', '01 File AAA' (with a duration of 01:23), 'Artist AAA', and 'Album AAA'. A 'USB Indicator' icon is visible in the top right corner of the screen.

Physical Control Panel: Below the screen is a control panel with several buttons and a knob. The buttons include 'DISP', 'FM/AM', 'CD', 'AUX', 'PHONE', and 'SETTINGS'. The 'AUX' button is highlighted with a line pointing to the screen. Below these buttons is a large circular knob labeled 'LIST PUSH SELECT'. To the left of the knob is a 'VOL' knob with a power symbol. To the right are 'BACK' and 'MENU' buttons. At the bottom of the panel are six preset buttons labeled '1' through '6', and an 'AUX IN' port.

Labels and Descriptions:

- USB Indicator:** Appears when a USB flash drive is connected.
- AUX Button:** Press to select USB flash drive (if connected).
- VOL/⏻ (Power/volume) Knob:** Press to turn the audio system on and off. Turn to adjust the volume.
- BACK Button:** Press to go back to the previous display.
- Seek/Skip Buttons:** Press ◀◀ or ▶▶ to change files. Press and hold to move rapidly within a file.
- MENU Button:** Press to display the menu items.
- Selector Knob:** Turn to change folders. Press and turn to select an item, then press to set your selection.

*1: Only AAC format files recorded with iTunes are playable on this unit.

How to Select a File from the Music Search List

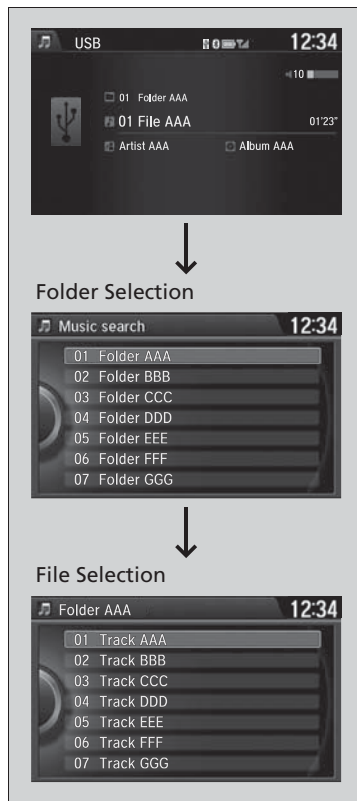

1. Press the **MENU** button.
2. Rotate to select **Music Search**, then press .
3. Rotate to select a folder.
4. Press to change the display to a list of files in that folder.
5. Rotate to select a file, then press .

▶▶ Playing a USB Flash Drive

Use the recommended USB flash drives.

- ▶ **General Information on the Audio System**
P. 294

Files in WMA format protected by digital rights management (DRM) cannot be played.

The audio system displays **Unplayable File**, and then skips to the next file.

If there is a problem, you may see an error message on the audio/information screen.

- ▶ **iPod/USB Flash Drive** P. 290

How to Select a Play Mode

You can select scan, repeat, and random modes when playing a file.

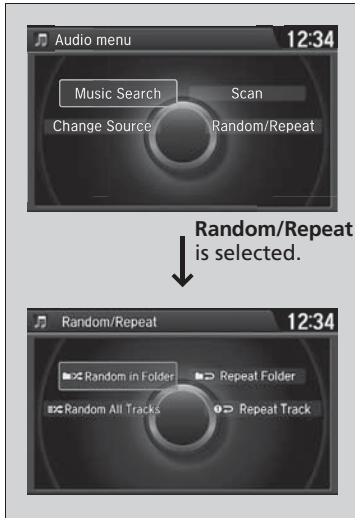

1. Press the **MENU** button.
2. Rotate to select **Scan** or **Random/Repeat**, then press .
3. Rotate to select a mode, then press .

To turn off a play mode

1. Press the **MENU** button.
2. Rotate to select the mode you want to turn off, then press .

How to Select a Play Mode

Play Mode Menu Items

Scan

Scan Folders: Provides 10-second sampling of the first file in each of the main folders.

Scan Tracks: Provides 10-second sampling of all files in the current folder.

Random/Repeat

Repeat Folder: Repeats all files in the current folder.

Repeat Track: Repeats the current file.

Random in Folder: Plays all files in the current folder in random order.

Random All Tracks: Plays all files in random order.

امداد خودرو فارما

تلفن شبانه روزی: ۰۲۱-۸۸۸۶۲۰۸۵

FarmaSOS.com

Playing *Bluetooth*® Audio

Your audio system allows you to listen to music from your *Bluetooth*-compatible phone.

This function is available when the phone is paired and connected to the vehicle's *Bluetooth*® HandsFreeLink® (HFL) system.

➤ **Phone Setup** P. 346

▶▶ Playing *Bluetooth*® Audio

Not all *Bluetooth*-enabled phones with streaming audio capabilities are compatible with the system.

For a list of compatible phones:

- U.S.: Visit www.handsfreelink.honda.com, or call 1-888-528-7876.
- Canada: Visit www.handsfreelink.ca, or call 1-888-528-7876.

In some states, it may be illegal to perform some data device functions while driving.

If more than one phone is paired to the HFL system, there will be a delay before the system begins to play.

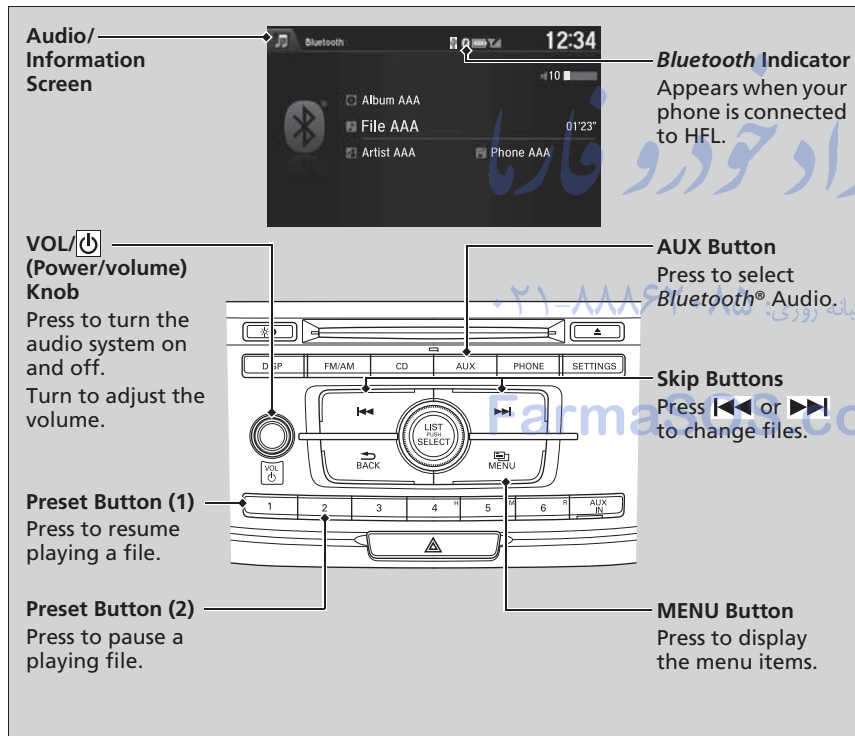

To Play *Bluetooth*® Audio Files

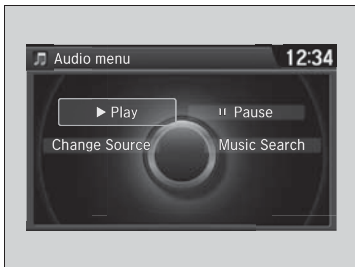

1. Make sure that your phone is paired and connected to HFL.
2. Press the **AUX** button.

If the phone is not recognized, another HFL-compatible phone, which is not compatible for *Bluetooth*® Audio, may already be connected.

To Play *Bluetooth*® Audio Files



To play the audio files, you may need to operate your phone. If so, follow the phone maker's operating instructions.

The pause function may not be available on some phones.

If any audio device is connected to the auxiliary input jack, you may need to press the **AUX** button repeatedly to select the *Bluetooth*® Audio system.

Switching to another mode pauses the music playing from your phone.

To pause or resume a file

1. Press the **MENU** button.
2. Rotate  to select **Play** or **Pause**, then press .

تلفن شبانه روزی: ۰۲۱-۸۸۸۶۲۰۸۵

FarmaSOS.com

Models with two displays

To use the audio system function, the power mode must be in ACCESSORY or ON.

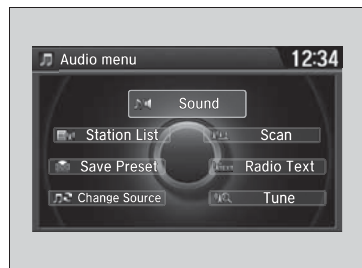
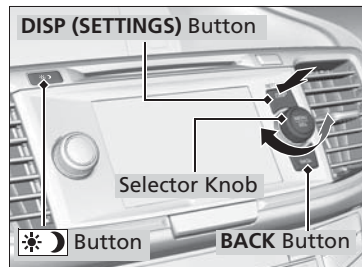

Use the selector knob, **DISP** and **BACK** buttons to access some audio functions.

Press to switch between the normal and extended display for some functions.

Selector knob: Rotate left or right to scroll through the available choices. Press to set your selection.

Also press to select any mode. The available mode includes **Sound**, **Change Source**, **Station List**, **Save Preset**, **Radio Text**, **Music Search**, and play modes. Play modes can be also selected from **Scan**, **Random/Repeat**, and so on.

BACK button: Press to go back to the previous display.

button: Press to change the audio/information screen brightness.

Press once and make an adjustment.

- ▶ Each time you press , the mode switches between the daytime mode, nighttime mode and **OFF** mode.

Audio System Basic Operation

These indications are used to show how to operate the selector knob.

Rotate to select.

Press to enter.

Audio Menu Items

- ▶ **Sound** P. 211
- ▶ **Station List** P. 215
- ▶ **Save Preset** P. 214, 219
- ▶ **Radio text** P. 216
- ▶ **Music Search** P. 221, 225, 231
- ▶ **Scan** P. 216, 222, 232
- ▶ **Random/Repeat** P. 222, 226, 232

Audio with Touch Screen

Use the touch screen to operate the audio system.

Selecting an Audio Source

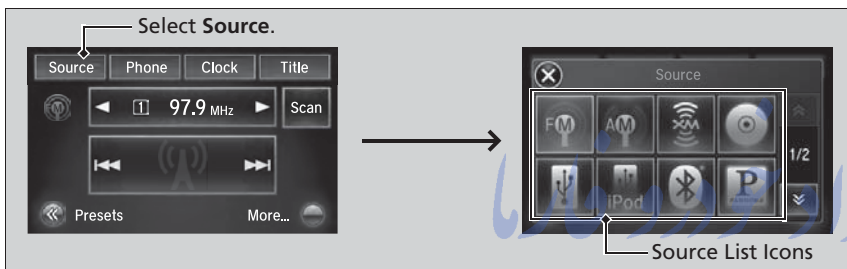

Select **Source**, then select an icon on the source list to switch the audio source.

Displaying the Menu Items

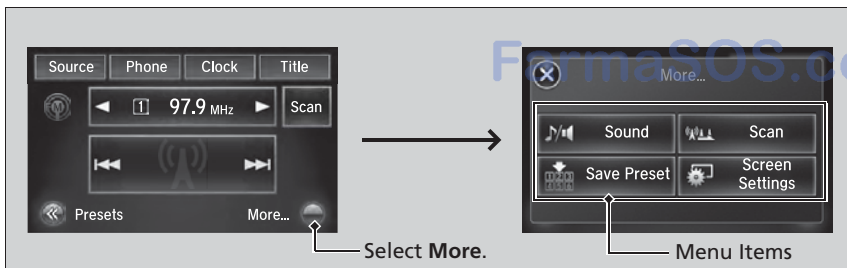

Select **More** to display the menu items.

Audio with Touch Screen

Icons that appear on the screen vary by the source selected.

Select to go back to the previous screen.

Use the icons to turn the page.

Selecting an Audio Source

You can change the order of source icons displayed.



1. Select **Source**, , then **Edit Order**.
2. Select two icons, then select **Done**.
The locations of these icons are switched.
To go back to the original display order, select **Default**.

Changing the Screen Settings

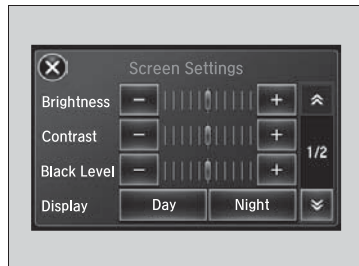

1. Select **More**, then **Screen Settings**.
2. Use **+**, **-** or others to adjust the setting.

Changing the Screen Settings

The followings are adjustable screen settings:

- **Brightness**
- **Contrast**
- **Black Level**
- **Display**
Changes between the daytime or nighttime modes.
- **Beep**
Mutes a beep that sounds every time you touch the screen.
- **Keyboard**
Changes the on-screen keyboard from the alphabetical order to the qwerty type.
- **Fade Timer**
Sets the screen black out timing.

Adjusting the Sound

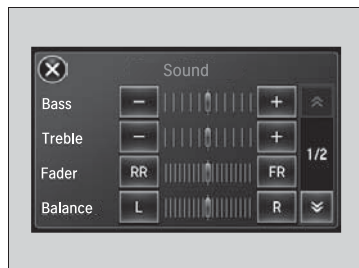

1. Select **More**, then **Sound**.
2. Use **+**, **-** or others to adjust the setting.

Adjusting the Sound

Select **Off**, **Low**, **Mid** or **High** for the SVC setting.

▶ **Adjusting the Sound** P. 211

امداد خودرو فارما

تلفن شبانه روزی: ۰۲۱-۸۸۸۶۲۰۸۵

Farma998.com

■ Displaying the Phone Operation Screen



Select **Phone** to switch to the phone operation screen.

▶ **Bluetooth® HandsFreeLink®** P. 338

▶▶ Displaying the Phone Operation Screen

The phone operation screen is available when a phone is paired to HFL.

تلفن شبانه روزی: ۰۲۱-۸۸۸۶۲۰۸۵

FarmaSOS.com

Audio/Information Screen

Displays the audio status and wallpaper. From this screen, you can go to various setup options.

Switching the Display



Using the  button

Press the  (display) button to change the display.

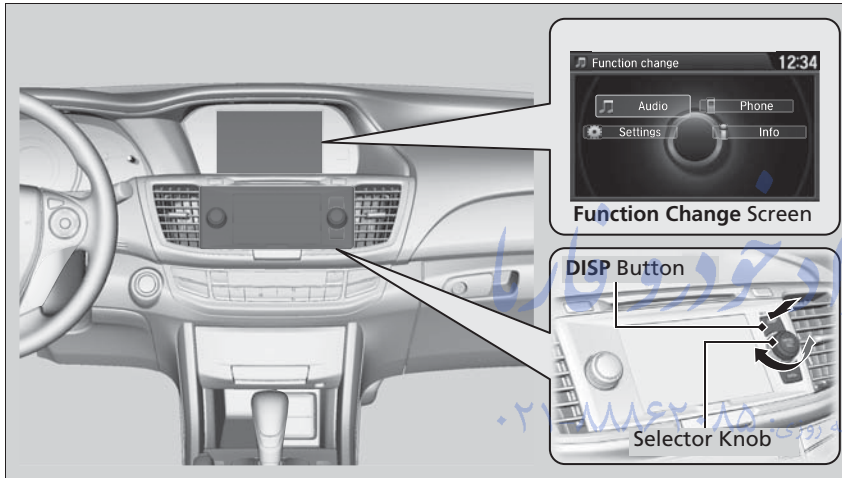

Using the DISP button



Press the **DISP** button to go to the **Function Change** screen.
 Rotate  to select **Audio**, **Phone**, **Info** or **Settings** and press .

■ Audio

Shows the current audio information.

■ Phone

Shows the HFL information. ➤ **Bluetooth® HandsFreeLink®** P. 338

■ Settings

Enters the customizing menu screen. ➤ **Customized Features** P. 298

■ Info

Shows the **Trip Computer** or **Clock/Wallpaper** information.

Press , rotate  to select an item, then press .

■ Trip computer (Current Drive)





Shows the range, and instant and average fuel economy of the current trip, as well as the average fuel economy from your last trip.

■ Trip computer (History of Trip A)

Shows the range, average fuel economy and distance traveled for the current trip, as well as the average fuel economy and distances traveled during the last three driving cycles.

Each time you reset the trip meter A, the information on the display updates. The history of the previous three driving cycles is kept.

■ Deleting the history manually

1. Press  on the **History of Trip A** screen.
2. Rotate  to select **Delete History**, then press .
3. You will receive a confirmation message on the screen. Rotate  to select **Yes**, then press .

■ Clock/Wallpaper

Shows a clock screen or an image you import.

آرداژ دزدو پارنا
تلفن شبانه روزی: ۰۲۱-۸۸۶۲۰۸۵
FarmaSOS.com

Wallpaper Setup

You can change, store, and delete the wallpaper on the audio/information screen.

Import wallpaper

You can import up to three images, one at a time, for wallpaper from a USB flash drive.



1. Connect the USB flash drive to the USB port.

▶ **USB Port** P. 175

2. Press and hold the **DISP** button to go to the **Settings** screen.

3. Rotate to select **System Settings**, then press .

▶ Repeat the procedure to select **Clock, Clock/Wallpaper Type**, then

Wallpaper.

4. Rotate to select **Add New**, then press .

▶ The picture name is displayed on the list.

5. Rotate to select a desired picture.

▶ The preview is displayed on the left side on the screen.







6. Press to save the data.

▶ The confirmation message will appear. Then the display will return to the wallpaper list.









Wallpaper Setup

- When importing wallpaper files, the image must be in the USB flash drive's root directory. Images in a folder cannot be imported.
- The file name must be fewer than 64 characters.
- The file format of the image that can be imported is BMP (bmp) or JPEG (jpg).
- The individual file size limit is 2 MB.
- The maximum image size is 1,680 x 936 pixels. If the image size is less than 420 x 234 pixels, the image is displayed in the middle of the screen with the extra area appearing in black.
- Up to 255 files can be selected.
- If the USB flash drive does not have any pictures, the **No files detected** message appears.



■ Select wallpaper

1. Press and hold the **DISP** button to go to the **Settings** screen.
2. Rotate  to select **System Settings**, then press .
 - ▶ Repeat the procedure to select **Clock/Wallpaper Type**, then **Wallpaper**.
 - ▶ The screen changes to the wallpaper list.
3. Rotate  to select a desired wallpaper.
 - ▶ The preview is displayed on the left side on the screen.
4. Press .
 - ▶ The pop-up menu appears on the screen.
5. Rotate  to select **Set**, then press .
 - ▶ The display will return to the wallpaper list.

■ Delete wallpaper

1. Press and hold the **DISP** button to go to the **Settings** screen.
2. Rotate  to select **System Settings**, then press .
 - ▶ Repeat the procedure to select **Clock/Wallpaper Type**, then **Wallpaper**.
 - ▶ The screen changes to the wallpaper list.
3. Rotate  to select a wallpaper that you want to delete.
 - ▶ The preview is displayed on the left side on the screen.
4. Press .
 - ▶ The pop-up menu appears on the screen.
5. Rotate  to select **Delete**, then press .
 - ▶ The confirmation message will appear.
6. Rotate  to select **OK**, then press  to delete completely.
 - ▶ The display will return to the wallpaper list.

▶▶ Wallpaper Setup

From the pop-up menu, rotate  to select **Preview** and press  to see a preview at full-size screen.

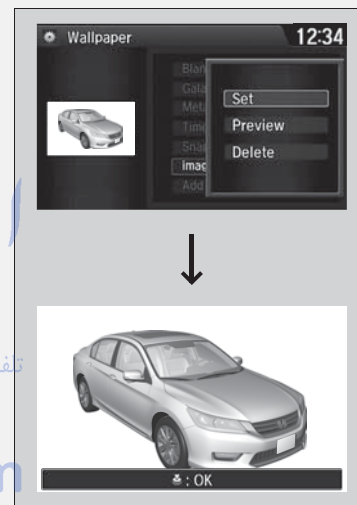

To go back to the previous screen, press  to select **OK**, or press the **BACK** button.

When the file size is large, it takes a while to be previewed.

Adjusting the Sound

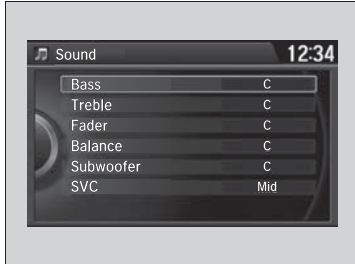
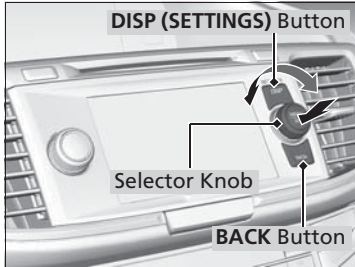

1. Press to switch to the **Audio menu** screen.
2. Rotate to select **Sound**, then press .

▶▶ Adjusting the Sound

The SVC has four modes: **Off**, **Low**, **Mid**, and **High**. SVC adjusts the volume level based on the vehicle speed. As you go faster, audio volume increases. As you slow down, audio volume decreases.

Rotate to scroll through the following choices:

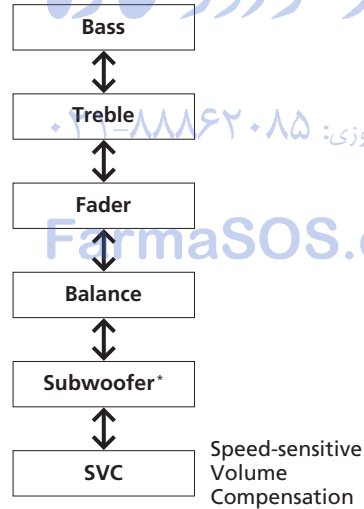

* Not available on all models

Display Setup

You can change the brightness or color theme of the audio/information screen.

Changing the Screen Brightness

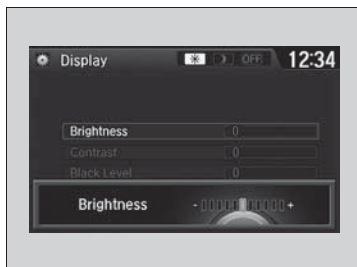

1. Press and hold the **DISP** button to go to the **Settings** screen.
2. Rotate to select **System Settings**, then press .
- ▶ Repeat the procedure to select **Display**.
3. Rotate to select **Brightness**, then press .
4. Rotate to adjust the setting, then press .

Changing the Screen Brightness

You can change the **Contrast** and **Black Level** settings in the same manner.

Changing the Screen's Color Theme

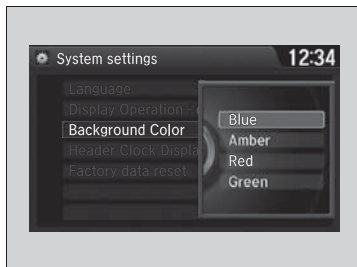

1. Press and hold the **DISP** button to go to the **Settings** screen.
2. Rotate to select **System Settings**, then press .
- ▶ Repeat the procedure to select **Others**.
3. Rotate to select **Background Color**, then press .
4. Rotate to select the setting you want, then press .

Playing AM/FM Radio

Audio/Information Screen —

Audio with Touch Screen —

Source —
Select to change a band or change an audio source.

VOL/⏻ (Volume/Power) Knob —
Press to turn the audio system on and off.
Turn to adjust the volume.

Presets
Select to store a station.

Source	Phone	Clock	Title
97.9 MHz	98.5 MHz	100.1 MHz	7-12
108.1 MHz	116.1 MHz	117.9 MHz	

To listen to a stored channel, select 1-6 (AM) or 1-12 (FM).

More —
Select to display the menu items.

Tune Up/Down Icons
Select ◀ or ▶ to tune the radio frequency.

Title
Select to display the information of the current station.

Scan
Select to sample each of the strongest stations on the selected band for 10 seconds.

Selector Knob
Press and turn to select an item, then press to set your selection.

Skip/Seek Icons
Select ◀◀ or ▶▶ to search up and down the selected band for a station with a strong signal.





BACK Button
Press to go back to the previous display.

Preset Memory

To store a station:

1. Tune to the selected station.

Selector Knob

2. Press  to switch to the **Audio menu** screen.
3. Rotate  to select **Save Preset**, then press .
4. Rotate  to select the preset number you want to store that station, then press .

Audio with Touch Screen

2. Select **More**.
3. Select **Save Preset**.
4. Select the preset number you want to store that station.

You can also store the station by pressing and holding a preset number.

▶▶ Playing AM/FM Radio

The **ST** indicator appears on the display indicating stereo FM broadcasts.

Stereo reproduction in AM is not available.

Switching the Audio Mode

Press the **SOURCE** button on the steering wheel.

▶ **Audio Remote Controls** P. 179





You can also switch the mode by pressing  and selecting **Change Source** on the **Audio menu** screen.

You can store 6 AM stations and 12 FM stations into the preset memory.

■ Radio Data System (RDS)





Provides text data information related to your selected RDS-capable FM station.

■ To find an RDS station from Station List

1. Press  to switch to the **Audio menu** screen while listening to an FM station.
2. Rotate  to select **Station List**, then press .
3. Rotate  to select the station, then press .

■ Manual update

Updates your available station list at any time.

1. Press  to switch to the **Audio menu** screen while listening to an FM station.
2. Rotate  to select **Station List**, then press .
3. Rotate  to select **UPDATE LIST**, then press .

▶▶ Radio Data System (RDS)

When you select an RDS-capable FM station, the RDS automatically turns on, and the frequency display changes to the station name. However, when the signals of that station become weak, the display changes from the station name to the frequency.

امداد خودرو فارما

تلفن شبانه روزی: ۰۲۱-۸۸۶۲۰۸۵

FarmaSOS.com

■ Radio text



Displays the radio text information of the selected RDS station.

1. Press  to switch to the **Audio menu** screen.
2. Rotate  to select **Radio Text**, then press .

■ Scan

Samples each of the strongest stations on the selected band for 10 seconds.

Selector Knob

1. Press  to switch to the **Audio menu** screen.
2. Rotate  to select **Scan**, then press .

To turn off scan, press  to select **Cancel Scan**, or press the **BACK** button.

Audio with Touch Screen

▶ **Playing AM/FM Radio** P. 213

To turn off scan, select **Stop Scan**.

تلفن شبانه روزی: ۰۲۱-۸۸۸۶۲۰۸۵

FarmaSOS.com

Playing SiriusXM® Radio *

Audio/Information Screen

Audio with Touch Screen

Source
Select to change an audio source.

VOL/Power (Volume/Power) Knob
Press to turn the audio system on and off.
Turn to adjust the volume.

Category Up/Down Icons
Select ◀ or ▶ to display and select an SiriusXM® Radio category.

Title
Select to display the information of the current station.

Scan
Select to sample each of the strongest stations on the selected band for 10 seconds.

Selector Knob
Press and turn to select an item, then press to set your selection.

Skip/Seek Icons
Select ◀◀ or ▶▶ to the previous or next channel.
In channel mode, select and hold to change the channel rapidly.

BACK Button
Press to go back to the previous display.

More
Select to display the menu items.

Presets
Select to store a station.

Source	Phone	Clock	Title
◀ Channel 001 ▶			▶ 7-12
1 CH001	2 CH002	3 CH003	
4 CH004	5 CH005	6 CH006	
Tune		More...	









To listen to a stored channel, select 1-12.

* Not available on all models





To Play the SiriusXM® Radio

1. Select the SiriusXM® mode.
 - **Audio Remote Controls** P. 179
 - **Audio with Touch Screen** P. 203

Selector Knob

2. Press  to switch to the **Audio menu** screen.
3. Rotate  to select **XM Tune Mode**, then press .
4. Rotate  to select **Channel Mode** or **Category Mode**, then press .
5. Rotate  to select **Channel List**, then press .
6. Rotate  to select a channel from a list, then press .

Audio with Touch Screen

2. Select **More**.
3. Select **Tune Mode**.
4. Select **CH Channel Mode** or **CAT Category Mode**.
5. Select a channel using the , , ,  icons on the tune mode screen or the preset numbers (1-12) on the preset mode screen.

▶▶ Playing SiriusXM® Radio *

In the channel mode, all available channels are selectable. In the category mode, you can select a channel within a category (Jazz, Rock, Classical, etc.).

There may be instances when SiriusXM® Radio does not broadcast all the data fields (artist name, title). This does not indicate a problem with your audio system.





FarmaSOS.com

Preset Memory

To store a station:

1. Tune to the selected station.

Selector Knob

2. Press  to switch to the **Audio menu** screen.
3. Rotate  to select **Save Preset**, then press .
4. Rotate  to select the preset number you want to store that station, then press .

Audio with Touch Screen

2. Select **More**.
3. Select **Save Preset**.
4. Select the preset number you want to store that station.

You can also store the station by pressing and holding a preset number.

▶▶ Playing SiriusXM® Radio*

You can store 12 SiriusXM® stations into the preset memory.

امداد خودرو فارما

تلفن شبانه روزی: ۰۲۱-۸۸۸۶۲۰۸۵

FarmaSOS.com

* Not available on all models

Playing a CD

Your audio system supports audio CDs, CD-Rs and CD-RWs in either MP3, WMA, or AAC*1 format. With the CD loaded, select the CD mode.

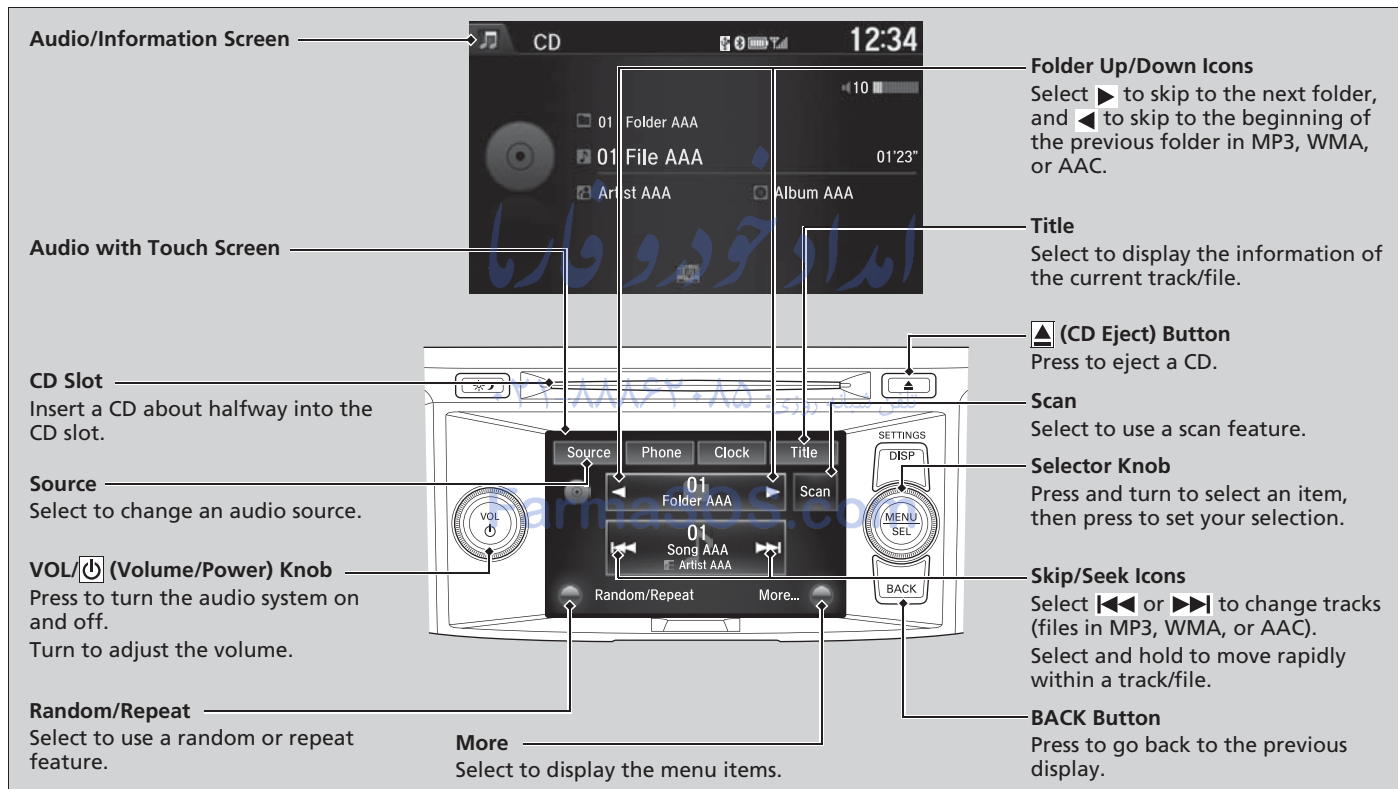

*1: Only AAC format files recorded with iTunes are playable on this unit.

How to Select a File from the Music Search List (MP3/WMA/AAC)

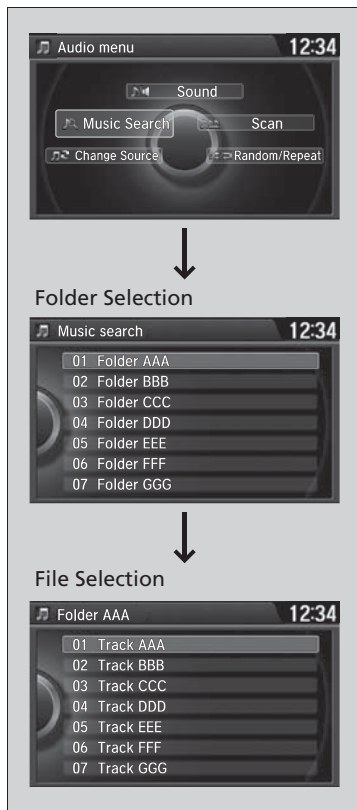

1. Press . Rotate to select **Music Search**, then press .

2. Rotate to select a folder.

3. Press to change the display to a list of files in that folder.

4. Rotate to select a file, then press .

▶▶ Playing a CD

NOTICE

Do not use CDs with adhesive labels. The label can cause the CD to jam in the unit.

WMA files protected by digital rights management (DRM) cannot be played.

The audio system displays **Unplayable File**, then skips to the next file.

Text data appears on the display under the following circumstances:

- When you select a new folder, file, or track.
- When you change the audio mode to CD.
- When you insert a CD.

If you eject the CD but do not remove it from the slot, the system reloads the CD automatically after several seconds.

Continued

How to Select a Play Mode

You can select scan, repeat, and random modes when playing a track or file.



Selector Knob

1. Press to switch to the **Audio menu** screen.
2. Rotate to select **Scan** or **Random/Repeat**, then press .
3. Rotate to select a mode, then press .

Audio with Touch Screen

1. Select **Scan** or **Random/Repeat**.
Playing a CD P. 220
2. Select a mode.

To turn off a play mode

Selector Knob

1. Press to switch to the **Audio menu** screen.
2. Rotate to select the mode you want to turn off, then press .

Audio with Touch Screen

1. Select **Scan** or **Random/Repeat**.
Playing a CD P. 220
2. Select the mode you want to turn off.

How to Select a Play Mode

Play Mode Menu Items

Scan

Scan Folders (MP3/WMA/AAC): Provides 10-second sampling of the first file in each of the main folders.

Scan Tracks: Provides 10-second sampling of all tracks on the CD (all files in the current folder in MP3, WMA, or AAC).

Random/Repeat

Repeat Folder (MP3/WMA/AAC): Repeats all files in the current folder.

Repeat Track: Repeats the current track/file.

Random in Folder (MP3/WMA/AAC): Plays all files in the current folder in random order.

Random All Tracks: Plays all tracks/files in random order.

Playing an iPod

Connect the iPod using your dock connector to the USB port, then select the iPod mode.

▶ USB Port P. 175

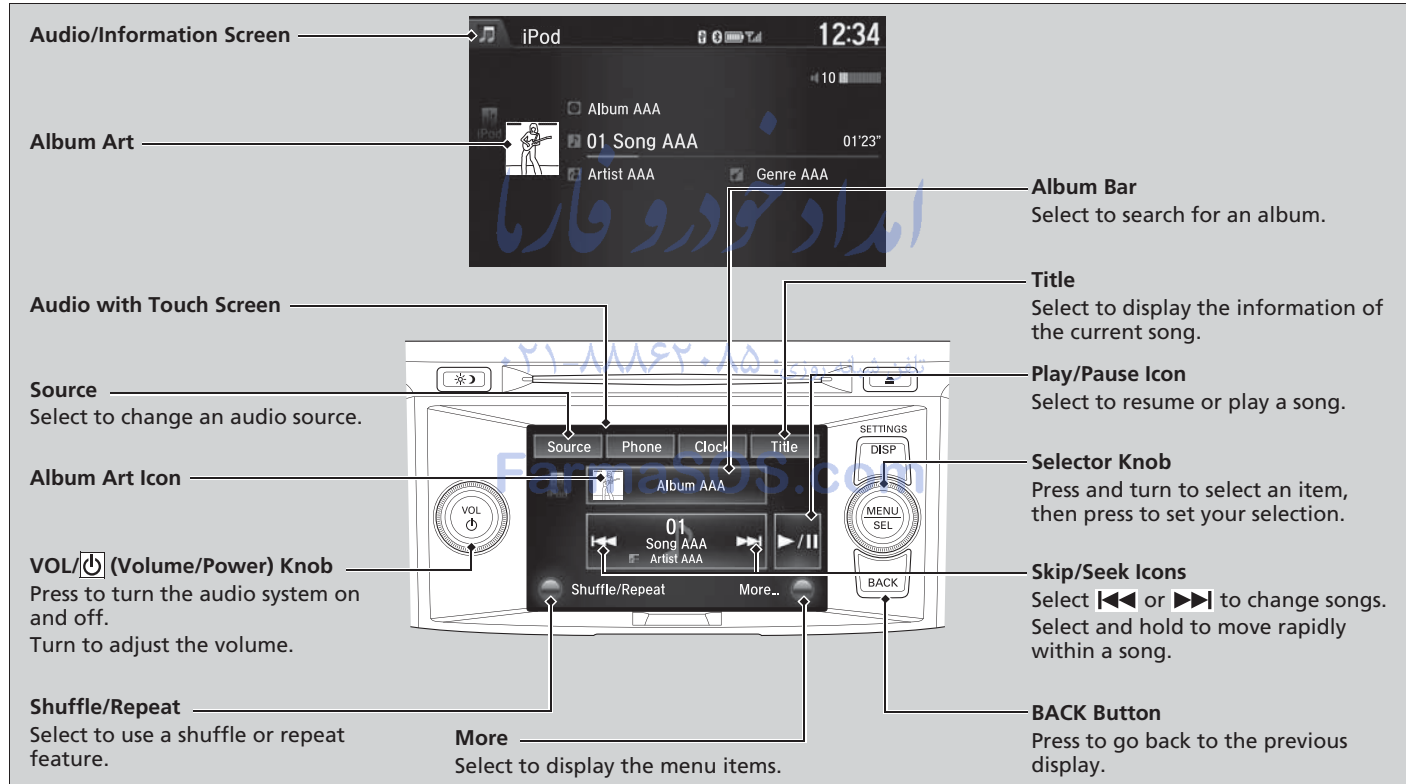

How to Select an Album

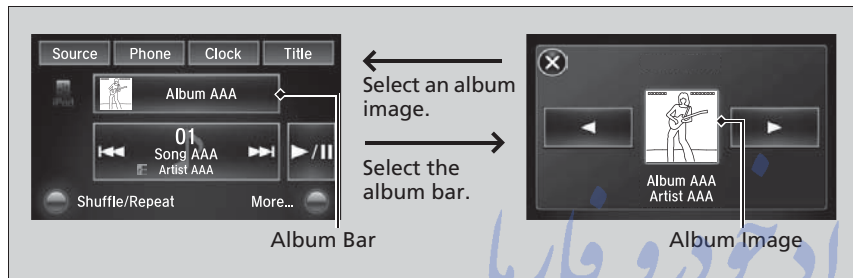

1. Select the album bar.

- ▶ The image of the current album is displayed.

2. Select ◀ or ▶ icon to search for an album.

- ▶ When the album image you are looking for appears, select it to play.

How to Select an Album

You cannot select an album while the vehicle is moving.

Select to go back to the previous screen.

How to Select a Song from the Music Search List



1. Press . Rotate to select **Music Search**, then press .
2. Rotate to select a menu.
3. Press to display the items on that menu.
4. Rotate to select an item, then press .

How to Select a Song from the Music Search List

Available operating functions vary on models or versions. Some functions may not be available on the vehicle's audio system.

If there is a problem, you may see an error message on the audio/information screen.

iPod/USB Flash Drive P. 290

امداد خودرو فارما

تلفن شبانه روزی: ۰۲۱-۸۸۸۶۲۰۸۵

FarmaSOS.com

How to Select a Play Mode

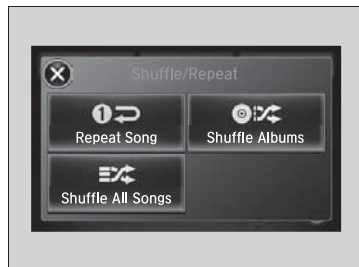

You can select repeat and shuffle modes when playing a file.

Selector Knob

1. Press to switch to the **Audio menu** screen.
2. Rotate to select **Shuffle/Repeat**, then press .
3. Rotate to select a mode, then press .

Audio with Touch Screen

1. Select **Shuffle/Repeat**.
▶ **Playing an iPod** P. 223
2. Select a mode.

How to Select a Play Mode

Play Mode Menu Items

Repeat Song: Repeats the current track.

Shuffle Albums: Plays all available albums in a selected list (playlists, artists, albums, songs, genres, or composers) in random order.

Shuffle All Songs: Plays all available files in a selected list (playlists, artists, albums, songs, genres, or composers) in random order.

To turn off a play mode

Selector Knob

1. Press to switch to the **Audio menu** screen.
2. Rotate to select the mode you want to turn off, then press .

Audio with Touch Screen

1. Select **Shuffle/Repeat**.
▶ **Playing an iPod** P. 223
2. Select the mode you want to turn off.

FarmaSOS.com

Compatible phones only

Playing Internet Radio

Connect a compatible phone through *Bluetooth*®.

iPhone

You can also connect the phone using your dock connector to the USB port. Select **Source** to select Pandora or Aha mode.

▶▶ Playing Internet Radio

Pandora®, the Pandora logo, and the Pandora trade dress are trademarks or registered trademarks of Pandora Media, Inc., used with permission. Pandora is currently available exclusively in the United States.

To find out if your phone is compatible with this feature, visit www.handshrink.honda.com, or call 1-888-528-7876.

To use this service in your vehicle, the Pandora® app must first be installed on your phone. Visit www.pandora.com for more information.

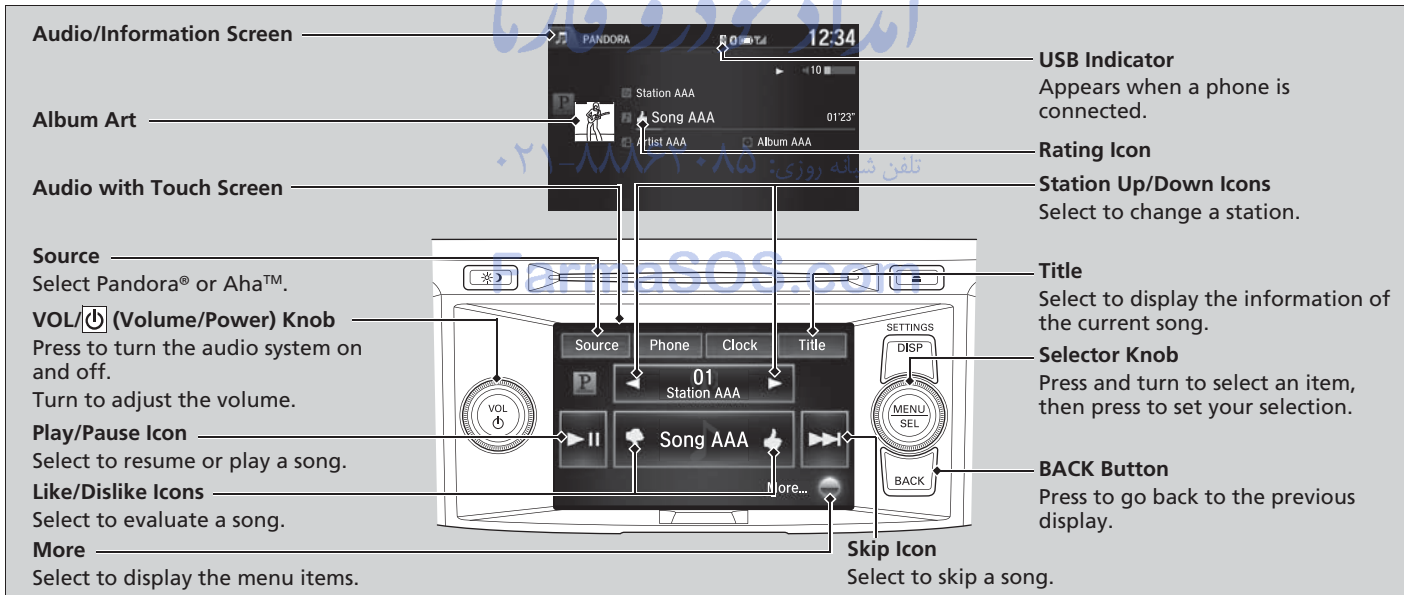

Continued



■ Pandora® Menu*

You can operate some of the Pandora® menu items from your vehicle's audio system. The available items are:

- **Like** (Thumbs-up)
- **Dislike** (Thumbs-down)
- **Station List**
- **Change Source**
- **Bookmark Track**
- **Bookmark Artist**
- **Play/Pause**
- **Sound**

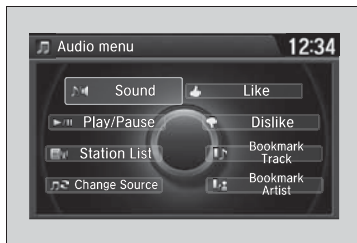
■ Operating a menu item



1. Press  to switch to the **Audio menu** screen. تلفن شبانه روزی: ۰۲۱-۸۸۸۶۳۰۸۵
2. Rotate  to select an item and press .

▶▶ Playing Internet Radio

Pandora® is free, personalized radio that plays music and comedy you'll love. Just start with the name of one of your favorite artists, songs, comedians or composers and Pandora® will create a custom station that plays similar tracks. Pandora® also features hundreds of genre stations ranging from Dubstep to Smooth Jazz to Power Workout.

If you cannot operate Pandora® through the audio system, it may be streaming through *Bluetooth®* Audio. Make sure Pandora® mode on your audio system is selected.

Changing Stations

To change stations, activate the Pandora® menu, select **Station List**, and then select a new station.

▶▶ Pandora® Menu*

Available operating functions vary on software versions. Some functions may not be available on the vehicle's audio system.

If there is a problem, you may see an error message on the audio/information screen.

 **Pandora®** P. 291

Pandora® may limit the total number of skips allowed on the service. If you dislike a track after the skip limit has been reached, your feedback will be saved but the current track will continue to play.



Aha™ Radio Menu

You can operate some of the Aha™ menu items from your vehicle's audio system. The available items are:

- Like
- Play/Pause
- Stations
- Change Source
- Dislike
- 15sec Back
- 30sec Skip
- View text
- View list
- Sound

Operating a menu item



1. Press  to switch to the **Audio menu** screen.
2. Rotate  to select an item and press .

Aha™ Radio Menu

Aha™ by Harman is a cloud-based service that organizes your favorite web content into live radio stations. You can access podcasts, internet radio, location-based services, and audio updates from social media sites.

Available operating functions vary on software versions. Some functions may not be available on the vehicle's audio system.

If there is a problem, you may see an error message on the audio/information screen.

 **Aha™ Radio*** P. 293

The menu items vary depending on the station you selected.

To use this service in your vehicle, the HondaLink app must be installed on your phone. Visit owners.honda.com/apps for more information.

You must have a previously set up Aha account prior to using the service in your vehicle. Visit www.aharadio.com for more information.

* Not available on all models

Playing a USB Flash Drive

Your audio system reads and plays sound files on a USB flash drive in either MP3, WMA or AAC*1 format.

Connect your USB flash drive to the USB port, then select the USB mode.

📌 **USB Port** P. 175

The diagram illustrates the audio system's interface for playing a USB flash drive. It is divided into two main sections: the **Audio/Information Screen** (top) and the **Audio with Touch Screen** (bottom).

Audio/Information Screen: Displays the source as 'USB' and the time as '12:34'. It shows a folder structure: '01 Folder AAA', '01 File AAA' (with a duration of '01'23"'), 'Artist AAA', and 'Album AAA'. A **USB Indicator** is shown in the top right corner.

Audio with Touch Screen: Features a central display showing '01 Folder AAA' and '01 File AAA' with 'Artist AAA' below it. Navigation options include 'Source', 'Phone', 'Clock', 'Title', and 'Scan'. At the bottom, there are 'Random/Repeat' and 'More...' buttons. The physical control panel includes a **VOL/Power Knob**, **Skip/Seek Icons**, **Selector Knob**, and a **BACK Button**.

Callouts and Descriptions:

- Audio/Information Screen:** Points to the top display area.
- USB Indicator:** Appears when a USB flash drive is connected.
- Folder Up/Down Icons:** Select ▶ to skip to the next folder, and ◀ to skip to the beginning of the previous folder.
- Source:** Select to change an audio source.
- Title:** Select to display the information of the current file.
- Scan:** Select to use a scan feature.
- Selector Knob:** Press and turn to select an item, then press to set your selection.
- BACK Button:** Press to go back to the previous display.
- More:** Select to display the menu items.
- VOL/Power Knob:** Press to turn the audio system on and off. Turn to adjust the volume.
- Skip/Seek Icons:** Select ◀◀ or ▶▶ to change files. Select and hold to move rapidly within a file.
- Random/Repeat:** Select to use a random or repeat feature.

*1: Only AAC format files recorded with iTunes are playable on this unit.

How to Select a File from the Music Search List

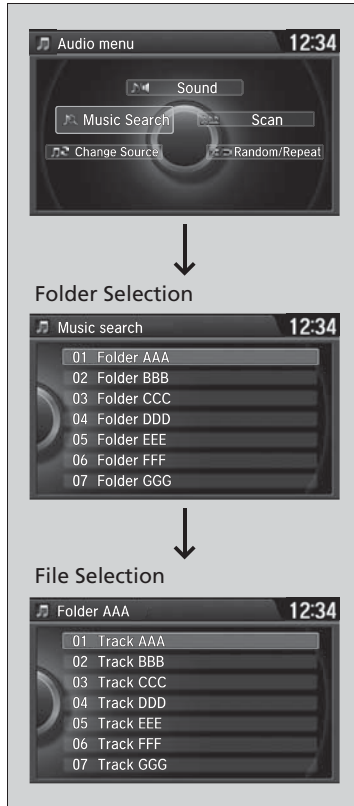

1. Press . Rotate to select **Music Search**, then press .
2. Rotate to select a folder.
3. Press to change the display to a list of files in that folder.
4. Rotate to select a file, then press .

امداد خودرو فارما

تلفن شبانه روزی: ۰۲۱-۸۸۸۶۲۰۸۵

FarmaSOS.com

▶▶ Playing a USB Flash Drive

Use the recommended USB flash drives.

- ▶ **General Information on the Audio System**
P. 294

Files in WMA format protected by digital rights management (DRM) cannot be played.

The audio system displays **Unplayable File**, and then skips to the next file.

If there is a problem, you may see an error message on the audio/information screen.

- ▶ **iPod/USB Flash Drive** P. 290

How to Select a Play Mode

You can select scan, repeat, and random modes when playing a file.



Selector Knob

1. Press to switch to the **Audio menu** screen.
2. Rotate to select **Scan** or **Random/Repeat**, then press .
3. Rotate to select a mode, then press .

Audio with Touch Screen

1. Select **Scan** or **Random/Repeat**.
Playing a USB Flash Drive P. 230
2. Select a mode.

How to Select a Play Mode

Play Mode Menu Items

Scan

Scan Folders: Provides 10-second sampling of the first file in each of the main folders.

Scan Tracks: Provides 10-second sampling of all files in the current folder.

Random/Repeat

Repeat Folder: Repeats all files in the current folder.

Repeat Track: Repeats the current file.

Random in Folder: Plays all files in the current folder in random order.

Random All Tracks: Plays all files in random order.

To turn off a play mode

Selector Knob

1. Press to switch to the **Audio menu** screen.
2. Rotate to select the mode you want to turn off, then press .

Audio with Touch Screen

1. Select **Scan** or **Random/Repeat**.
Playing a USB Flash Drive P. 230
2. Select the mode you want to turn off.

Playing *Bluetooth*® Audio

Your audio system allows you to listen to music from your *Bluetooth*-compatible phone.

This function is available when the phone is paired and connected to the vehicle's *Bluetooth*® HandsFreeLink® (HFL) system.

☒ **Phone Setup** P. 346

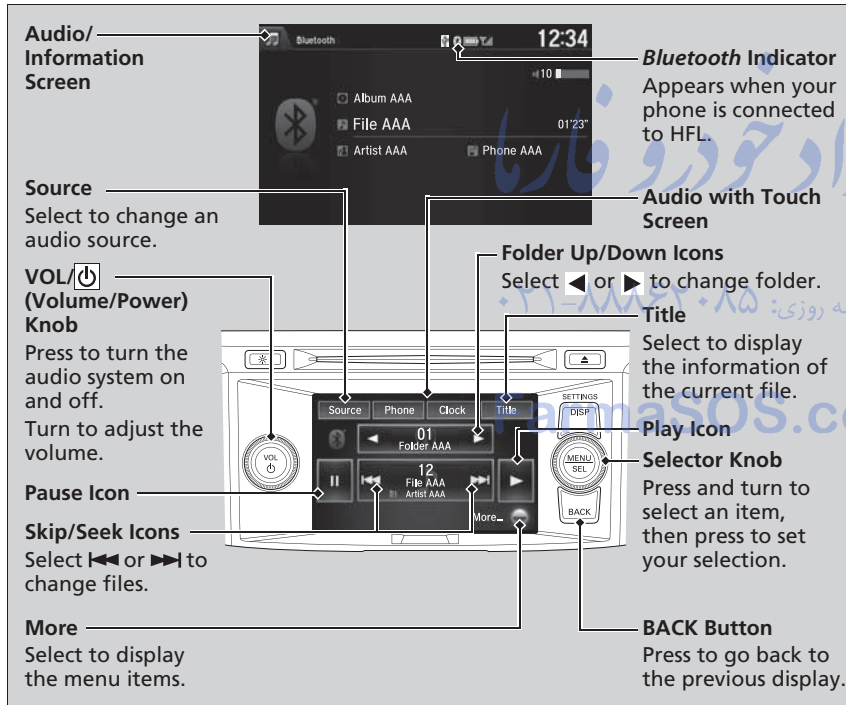

☒ Playing *Bluetooth*® Audio

Not all *Bluetooth*-enabled phones with streaming audio capabilities are compatible with the system. For a list of compatible phones:

- U.S.: Visit www.handsfreelink.honda.com, or call 1-888-528-7876.
- Canada: Visit www.handsfreelink.ca, or call 1-888-528-7876.

In some states, it may be illegal to perform some data device functions while driving.

If more than one phone is paired to the HFL system, there will be a delay before the system begins to play.

Continued

■ To Play *Bluetooth*® Audio Files

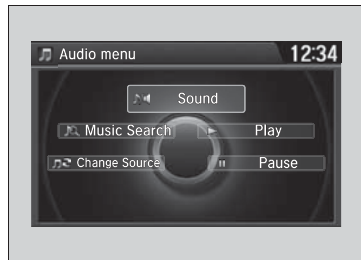



1. Make sure that your phone is paired and connected to HFL.
2. Select the *Bluetooth*® Audio mode.

If the phone is not recognized, another HFL-compatible phone, which is not compatible for *Bluetooth*® Audio, may already be connected.

■ To pause or resume a file

Selector knob

1. Press  to switch to the **Audio menu** screen.
2. Rotate  to select **Play** or **Pause**, then press . تلفن شبانه روزی: ۰۸۵-۸۸۸۶۲۰۸۵

Audio with Touch Screen

Select the play icon or pause icon.

▶▶ To Play *Bluetooth*® Audio Files

To play the audio files, you may need to operate your phone. If so, follow the phone maker's operating instructions.

The pause function may not be available on some phones.

Switching to another mode pauses the music playing from your phone.

امداد خودرو فارما

FarmaSOS.com

Models with navigation system

To use the audio system function, the power mode must be in ACCESSORY or ON.

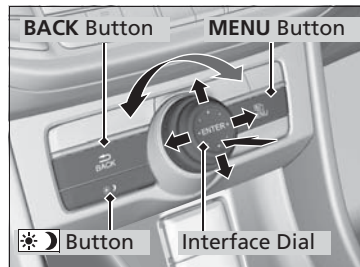

Use the interface dial or **MENU** button to access some audio functions.

Press to switch between the normal and extended display for some functions.

Interface dial: Rotate left or right to scroll through the available choices. Press to set your selection. Move right, left, up or down to select secondary menu.

MENU button: Press to select any mode. The available mode includes **Sound, Change Source, Refresh Station List, Save Preset, Radio Text, Music Search**, and play modes. Play modes can be also selected from **Scan, Random/Repeat**, and so on.

BACK button: Press to go back to the previous display.

button: Press to change the audio/information screen brightness.

Press once and make an adjustment.

- ▶ Each time you press , the mode switches between the daytime mode, nighttime mode and off mode.

Audio System Basic Operation

Voice Control System

The audio system is voice operable. See the navigation system manual for details.

These indications are used to show how to operate the interface dial.

Rotate to select.

Press to enter.

Move , , or to select secondary menu.

Audio Menu Items

- ▶ **Sound** P. 242
- ▶ **Refresh Station List** P. 254
- ▶ **Save Preset** P. 253, 258
- ▶ **Radio text** P. 255
- ▶ **Music Search** P. 260, 264, 274, 284
- ▶ **Scan** P. 255, 261, 265, 285
- ▶ **Random/Repeat** P. 261, 265, 275, 285

Audio with Touch Screen

Use the touch screen to operate the audio system.

Selecting an Audio Source

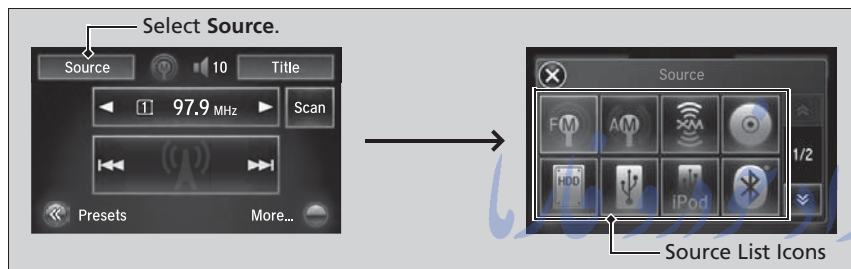

Select **Source**, then select an icon on the source list to switch the audio source.

Displaying the Menu Items

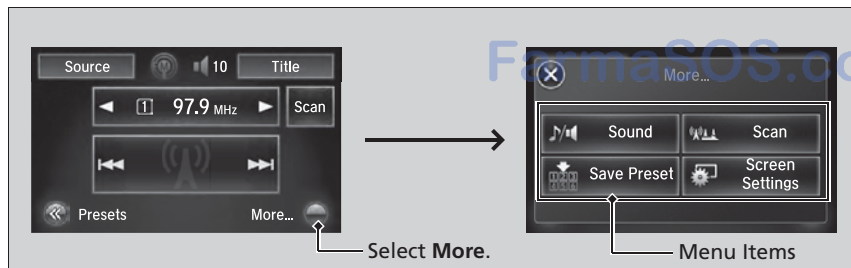

Select **More** to display the menu items.

▶▶ Audio with Touch Screen

Icons that appear on the screen vary by the source selected.

Select **X** to go back to the previous screen.

Use the **◀▶** **⏪⏩** **⏴⏵** icons to turn the page.

▶▶ Selecting an Audio Source

You can change the order of source icons displayed.

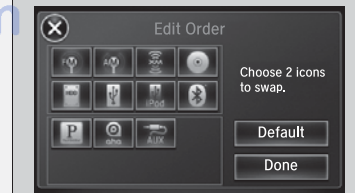
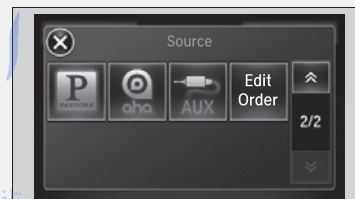

1. Select **Source**, **⏴**, then **Edit Order**.
2. Select two icons, then select **Done**.
The locations of these icons are switched.
To go back to the original display order, select **Default**.

Adjusting the Sound

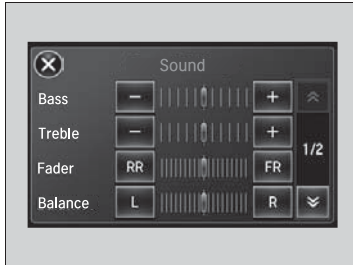

1. Select **More**, then **Sound**.
2. Use **+**, **-** or others to adjust the setting.

Changing the Screen Settings

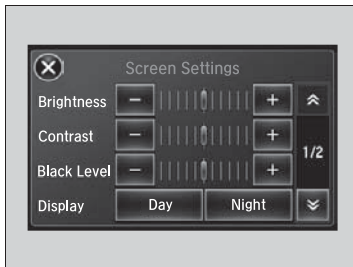

1. Select **More**, then **Screen Settings**.
2. Use **+**, **-** or others to adjust the setting.

Adjusting the Sound

Select **Off**, **Low**, **Mid** or **High** for the SVC setting.

▶ **Adjusting the Sound** P. 242

Changing the Screen Settings

The followings are adjustable screen settings:

- **Brightness**
- **Contrast**
- **Black Level**
- **Display**
Changes between the daytime or nighttime modes.
- **Beep**
Mutes a beep that sounds every time you touch the screen.
- **Keyboard**
Changes the on-screen keyboard from the alphabetical order to the qwerty type.
- **Fade Timer**
Sets the screen black out timing.

Audio/Information Screen

Displays the audio status and wallpaper. From this screen, you can go to various setup options.

Switching the Display

Press the  (display) button to change the display.

Switching the Display

You can also use the **AUDIO**, **NAV**, **PHONE** and **INFO** buttons to go to the corresponding display.

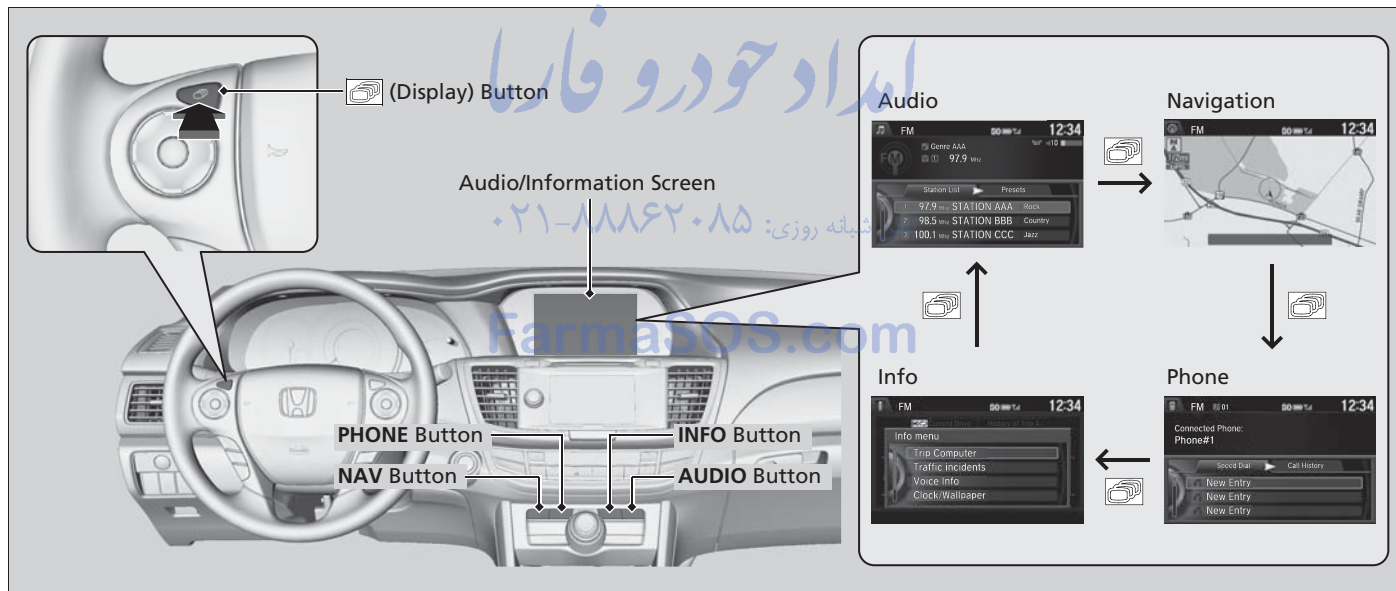

■ Audio

Shows the current audio information.

■ Navigation

Shows the navigation screen.  **Refer to the Navigation System Manual**

■ Phone

Shows the HFL information.  **Bluetooth® HandsFreeLink®** P. 375

■ Info

Shows the **Trip Computer** or **Clock/Wallpaper** and other information. Rotate  to select an item, then press .





■ Trip computer (Current Drive)

Shows the range, and instant and average fuel economy of the current trip, as well as the average fuel economy from your last trip.  تلفن شبانه روزی: ۰۲۱-۸۸۶۴۰۸۵

■ Trip computer (History of Trip A)

Shows the range, average fuel economy and distances traveled for the current trip, as well as the average fuel economy and distances traveled during the last three driving cycles.  www.papaya.ir
Each time you reset the trip meter A, the information on the display updates. The history of the previous three driving cycles is kept.

■ Deleting the history manually

1. Move  on the **History of Trip A** screen to select **Delete History**, then press .
2. You will receive a confirmation message on the screen. Rotate  to select **Yes**, then press .

■ Clock/Wallpaper

Shows a clock screen or an image you import.

Continued

Wallpaper Setup

You can change, store, and delete the wallpaper on the audio/information screen.

Import wallpaper

You can import up to three images, one at a time, for wallpaper from a USB flash drive.

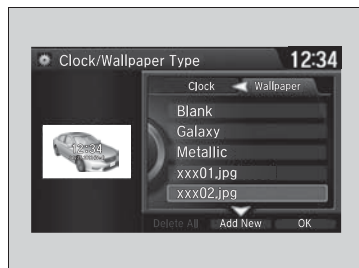
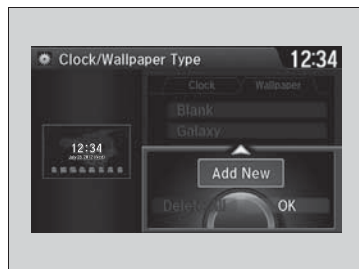











1. Connect the USB flash drive to the USB port.
 - ▶ **USB Port P. 175**
2. Press the **SETTINGS** button.
3. Rotate to select **System Settings**, then press .
4. Move or to select the **Clock** tab.
5. Rotate to select **Clock/Wallpaper Type**, then press .
6. Move to select **Wallpaper**.
 - ▶ The screen will change to the wallpaper list.
7. Move to select **Add New**, then press .
8. Rotate to select a desired picture.
 - ▶ The preview is displayed on the left side on the screen.
9. Press , then move to select **Start Import**.
 - ▶ The confirmation message will appear. Then the display will return to the wallpaper list.















Wallpaper Setup

- When importing wallpaper files, the image must be in the USB flash drive's root directory. Images in a folder cannot be imported.
- The file name must be fewer than 64 characters.
- The file format of the image that can be imported is BMP (bmp) or JPEG (jpg).
- The individual file size limit is 6 MB.
- The maximum image size is 1,680 x 936 pixels. If the image size is less than 420 x 234 pixels, the image is displayed in the middle of the screen with the extra area appearing in black.
- Up to 255 files can be selected.
- If the USB flash drive does not have any pictures, the **No files detected** message appears.



■ Select wallpaper

1. Press the **SETTINGS** button.
2. Rotate  to select **System Settings**, then press .
3. Move  or  to select the **Clock** tab.
4. Rotate  to select **Clock/Wallpaper Type**, then press .
5. Move  to select **Wallpaper**.
 - ▶ The screen changes to the wallpaper list.
6. Rotate  to select a desired wallpaper.
 - ▶ The preview is displayed on the left side on the screen.
7. Press .
- ▶ The pop-up menu appears on the screen.
8. Rotate  to select **Set**, then press .
 - ▶ The display will return to the wallpaper list.

■ Delete wallpaper

1. Press the **SETTINGS** button.
2. Rotate  to select **System Settings**, then press .
3. Move  or  to select the **Clock** tab.
4. Rotate  to select **Clock/Wallpaper Type**, then press .
5. Move  to select **Wallpaper**.
 - ▶ The screen changes to the wallpaper list.
6. Rotate  to select a wallpaper that you want to delete, then press .
 - ▶ The preview is displayed on the left side on the screen.
7. Press .
- ▶ The pop-up menu appears on the screen.
8. Rotate  to select **Delete**, then press .
 - ▶ The confirmation message will appear.
9. Rotate  to select **Yes**, then press  to delete completely.
 - ▶ The display will return to the wallpaper list.

Wallpaper Setup

From the pop-up menu, rotate  to select **Preview** and press  to see a preview at full-size screen.



To go back to the previous screen, press  to select **OK**, or press the **BACK** button.

When the file size is large, it takes a while to be previewed.

Adjusting the Sound

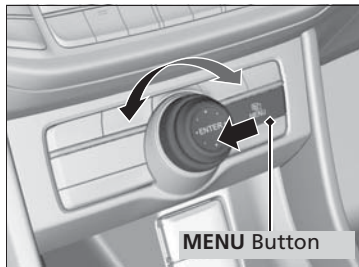

1. Press the **MENU** button.
2. Rotate to select **Sound**, then press .

▶▶ Adjusting the Sound

The SVC has four modes: **Off**, **Low**, **Mid**, and **High**. SVC adjusts the volume level based on the vehicle speed. As you go faster, audio volume increases. As you slow down, audio volume decreases.



Rotate to scroll through the following choices:

Bass



Treble



Fader



Balance



Subwoofer



SVC

Speed-sensitive
Volume
Compensation

Display Setup

You can change the brightness or color theme of the audio/information screen.

Changing the Screen Brightness

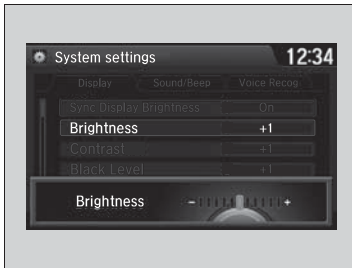

1. Press the **SETTINGS** button.
2. Rotate to select **System Settings**, then press .
3. Move or to select the **Display** tab.
4. Rotate to select **Brightness**, then press .
5. Rotate to adjust the setting, then press .

Changing the Screen Brightness

You can change the **Contrast** and **Black Level** settings in the same manner.



Changing the Screen's Color Theme



1. Press the **SETTINGS** button.
2. Rotate to select **System Settings**, then press .
3. Move or to select the **Others** tab.
4. Rotate to select **Background Color**, then press .
5. Rotate to select the setting you want, then press .

Voice Control Operation

Your vehicle has a voice control system that allows hands-free operation of most of the navigation system functions.

The voice control system uses the  (Talk) and  (hang-up/back) buttons on the steering wheel and a microphone near the map lights on the ceiling.



Voice Recognition

To achieve optimum voice recognition when using the navigation voice control system:

- Make sure the correct screen is displayed for the voice command that you are using.
- Close the windows and moonroof.
- Adjust the dashboard and side vents so air does not blow onto the microphone on the ceiling.
- Speak clearly in a clear, natural speaking voice without pausing between words.
- Reduce any background noise if possible. The system may misinterpret your command if more than one person is speaking at the same time.
- Refer to the Voice Help feature.

➤ Refer to the Navigation System Manual

Voice Control Operation

When you press the  button, a helpful prompt asks what you would like to do. Press and release the  button again to bypass this prompt and give a command.

Voice Recognition

The voice control system can only be used from the driver's seat because the microphone unit removes noises from the front passenger's side.

Voice Portal Commands

The system accepts these commands on the **Voice Portal** screen.

- *Call Your contact name*
- *Call Phone Number*
- *Find nearest POI category name*
- *Go home*
- *Route menu*
- *Cancel route*

Phone Commands

The system accepts these commands on any screen.

- *Call by number*
- *Call by name*
- *Call Phone Number*
- *Call your contact name*

Contacts that are imported from your phone to the vehicle are all made available by voice. Voice Tags can also be recorded for each of your Speed Dial entries.

Navigation Commands

☞ Refer to the Navigation System Manual

Info Commands

The system accepts these commands on any screen.

- *Trip computer*
- *Traffic information*
- *Display clock*
- *Display wallpaper*

On Screen Commands

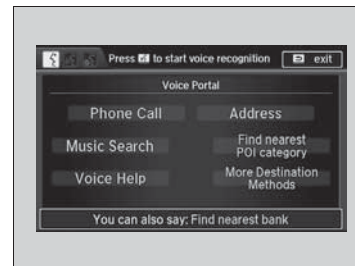

When the [Talk icon] (Talk) button is pressed, available voice commands appear on the screen.

For a complete list of commands, say "Voice Help" after the beep.

■ Climate Control Commands

The system accepts these commands on most screens.

- *Climate control automatic**¹
- *Climate control off*¹
- *Air conditioner on**¹
- *Air conditioner off*¹
- *Climate control defrost on**¹
- *Climate control defrost off**¹
- *Rear defrost on**¹
- *Rear defrost off**¹
- *Climate control fresh air*
- *Climate control recirculate*
- *Climate control vent*
- *Climate control bi-level*
- *Climate control floor*
- *Climate control floor and defrost*
- *Fan speed up*
- *Fan speed down*
- *Fan speed #* (#: 1 to 7)
- *Temperature # degrees* (#: 57 to 87°F, 15 to 29°C)
- *Driver temperature # degrees* (#: 57 to 87°F, 15 to 29°C)
- *Passenger temperature # degrees* (#: 57 to 87°F, 15 to 29°C)
- *Temperature up*
- *Temperature down*

- *Driver temperature up*
- *Driver temperature down*
- *Passenger temperature up*
- *Passenger temperature down*
- *Temperature max heat*
- *Temperature max cool*
- *Driver temperature max heat*
- *Driver temperature max cool*
- *Passenger temperature max heat*
- *Passenger temperature max cool*
- *Climate control sync on**¹
- *Climate control sync off**¹

*1: These commands toggle the function on and off, so the command may not match your intended action.

■ Audio Commands

The system accepts these commands on most screens.

■ Using Song By Voice™

Song By Voice™ is a feature that allows you to select music from your Hard Disk Drive or iPod device using your voice.

To activate this mode, you must press the  (Talk) button on the **Voice Portal** screen and say: "Music search."

■ Song By Voice™ commands

- *Music search*
- *List album* (specify album)
- *List artist* (specify artist)
- *List composer* (specify composer)
- *List genre* (specify genre)
- *List playlist* (specify playlist)
- *Play album* (specify album)
- *Play artist* (specify artist)
- *Play composer* (specify composer)
- *Play genre* (specify genre)
- *Play playlist* (specify playlist)
- *Play song* (specify song)
- *What am I listening to?*
- *Who am I listening to?*
- *Who is this?*
- *What's playing?*
- *Who's playing?*
- *What album is this?*

■ HDD commands

- *Hard Disk Drive play*
- *Hard Disk Drive play track #* (#: 1 to 30)
- *Hard Disk Drive skip forward*
- *Hard Disk Drive skip back*
- *Hard Disk Drive album up*^{*2}
- *Hard Disk Drive album down*^{*2}
- *Hard Disk Drive track up*
- *Hard Disk Drive track down*
- *Hard Disk Drive playlist up*^{*2}
- *Hard Disk Drive playlist down*^{*2}
- *Hard Disk Drive track random*^{*1}
- *Hard Disk Drive track repeat*^{*1}
- *Hard Disk Drive track scan*^{*1}
- *Hard Disk Drive normal play*
- *What am I listening to?*
- *Who am I listening to?*
- *Who is this?*
- *What's playing?*
- *Who's playing?*
- *What album is this?*

*1: These commands toggle the function on and off, so the command may not match your intended action.

*2: These commands are available only in the corresponding playback mode. For example, "Artist" commands are available only in "Artist" mode.

■ Radio commands

- *Audio on*^{*1}
- *Audio off*^{*1}
- *Radio on*^{*1}
- *Radio off*^{*1}
- *Radio select FM*
- *Radio select AM*
- *Radio tune to # FM*
(#: frequency from 87.7 to 107.9)
- *Radio tune to # AM*
(#: frequency from 530 [five thirty] to 1710 [seventeen ten])
- *Radio seek up*
- *Radio seek down*
- *Radio next station*
- *Radio preset #* (#: 1 to 12) *تلفن شبانه روزی*
- *Radio FM preset #* (#: 1 to 12)
- *Radio AM preset #* (#: 1 to 6)
- *Radio scan*^{*1}
- *Radio select XM*
- *XM channel #*
(#: 0 to 255 [two fifty five])
- *XM channel down*
- *XM category up*
- *XM category down*
- *XM preset #* (#: 1 to 12)
- *XM scan*^{*1}
- *XM category mode*
- *XM channel mode*

*1: These commands toggle the function on and off, so the command may not match your intended action.

NOTE:

Radio volume levels cannot be controlled using voice control.

■ Disc commands

- *Disc play*
- *Disc play track #* (#: 1 to 30)
- *Disc skip forward*
- *Disc skip back*
- *Disc track random*^{*1}
- *Disc track repeat*^{*1}
- *Disc track scan*^{*1}
- *Disc folder up*
- *Disc folder down*
- *Disc folder random*^{*1}
- *Disc folder repeat*^{*1}
- *Disc folder scan*^{*1}
- *Disc normal play*

*1: These commands toggle the function on and off, so the command may not match your intended action.

■ iPod commands

- *iPod play*
- *iPod play track # (#: 1 to 30)*
- *iPod skip forward*
- *iPod skip back*
- *iPod track shuffle**¹
- *iPod album shuffle**¹
- *iPod track repeat**¹
- *iPod normal play*
- *What am I listening to?*
- *Who am I listening to?*
- *Who is this?*
- *What's playing?*
- *Who's playing?*
- *What album is this?*

*1: These commands toggle the function on and off, so the command may not match your intended action.

■ USB commands

- *USB play*
- *USB play track # (#: 1 to 30)*
- *USB skip forward*
- *USB skip back*
- *USB track random**¹
- *USB track repeat**¹
- *USB track scan**¹
- *USB folder up*
- *USB folder down*
- *USB folder random**¹
- *USB folder repeat**¹
- *USB folder scan**¹
- *USB normal play*

*1: These commands toggle the function on and off, so the command may not match your intended action.

FarmaSOS.com

■ Bluetooth® Audio commands

- *Bluetooth Audio play*
- *Bluetooth Audio skip forward*
- *Bluetooth Audio skip back*
- *Bluetooth Audio group up*
- *Bluetooth Audio group down*
- *Bluetooth Audio pause*
- *Bluetooth Audio resume*
- *Bluetooth Audio track random*
- *Bluetooth Audio track repeat*

NOTE:

Bluetooth® Audio commands may not work on some phones or Bluetooth® Audio devices.

■ AUX commands

- *Auxiliary play*

■ Pandora® commands*

The system accepts these commands while the Pandora® is playing.

- *Pandora play*
- *Pandora skip forward*
- *Pandora station up*
- *Pandora station down*
- *Pandora pause*
- *Pandora resume*
- *Pandora thumbs up*
- *Pandora thumbs down*

■ Aha™ Radio commands

The system accepts these commands while the Aha™ is playing.

- *Aha radio play*
- *Aha radio skip forward*
- *Aha radio skip back*
- *Aha radio station up*
- *Aha radio station down*
- *Aha radio resume*
- *Aha radio pause*
- *Aha radio like*
- *Aha radio dislike*

تلفن شبانه روزی: ۰۲۱-۸۸۶۲۰۸۵

FarmaSOS.com

■ Internet service commands

- *Internet service play*
- *Internet service skip forward**1
- *Internet service skip back**1
- *Internet service station up**1
- *Internet service station down**1
- *Internet service resume**1
- *Internet service pause**1
- *Internet service like**1
- *Internet service dislike**1

*1: The system accepts these commands while the Internet service is playing.

* Not available on all models

Keyboard Entry Commands

In keyboard screen, letters can be selected by saying each individual letter or by saying a keyword phrase. These keyword phrases are:

Letters

Say . . .	Or say . . .
A	Apple/Alpha
B	Boy/Bravo
C	Charlie
D	Dog/Delta
E	Edward/Echo
F	Frank/Foxtrot
G	George/Golf
H	Henry/Hotel
I	Igloo/India
J	John/Juliet
K	King/Kilo
L	Larry/Lima
M	Mary/Mike
N	Nancy/November
O	Oscar
P	Paul/Papa
Q	Queen/Quebec
R	Robert/Romeo
S	Sam/Sierra
T	Tom/Tango
U	Uncle/Uniform
V	Victor
W	William/Whiskey
X	X-ray
Y	Yellow/Yankee
Z	Zebra/Zulu

Numbers

Number . . .	Or say . . .
0	Zero
1	One
2	Two
3	Three
4	Four
5	Five
6	Six
7	Seven
8	Eight
9	Nine

■ Symbols

Symbol . . .	Or say . . .
-	<i>Hyphen</i>
!	<i>Exclamation point</i>
"	<i>Double Quote</i>
#	<i>Pound</i>
\$	<i>Dollar</i>
%	<i>Percent</i>
&	<i>Ampersand</i>
'	<i>Apostrophe</i>
(<i>Open Parenthesis</i>
)	<i>Close Parenthesis</i>
~	<i>Tilde</i>
/	<i>Slash</i>
<	<i>Less than</i>
>	<i>Greater than</i>
{	<i>Open Brace</i>
}	<i>Close Brace</i>

■ Accented letters

Symbol . . .	Or say . . .
À	<i>A grave</i>
Â	<i>A circumflex</i>
Ä	<i>A umlaut</i>
Ç	<i>C cedilla</i>
È	<i>E grave</i>
É	<i>E acute</i>
Ê	<i>E circumflex</i>
Ë	<i>E umlaut</i>
Ì	<i>I grave</i>
Î	<i>I circumflex</i>
Ï	<i>I umlaut</i>
Ô	<i>O circumflex</i>
Ù	<i>U grave</i>
Û	<i>U circumflex</i>
Ü	<i>U umlaut</i>

FarmaSOS.com

■ Punctuation marks

Symbol . . .	Or say . . .
@	<i>At Sign</i>
^	<i>Caret</i>
*	<i>Asterisk</i>
_	<i>Underscore</i>
`	<i>Back Quote</i>
,	<i>Comma</i>
.	<i>Dot</i>
?	<i>Question mark</i>
:	<i>Colon</i>
;	<i>Semicolon</i>
+	<i>Plus</i>

Playing AM/FM Radio

Audio/Information Screen

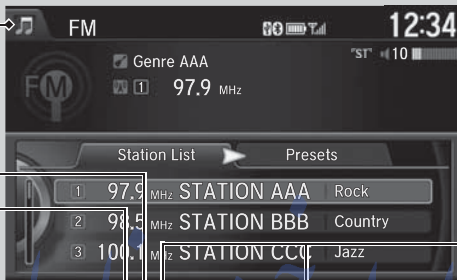

Audio with Touch Screen

Source

Select to change a band or change an audio source.

(Power) Button

Press to turn the audio system on and off.

VOL (Volume) Knob

Turn to adjust the volume.

Presets

Select to store a station.

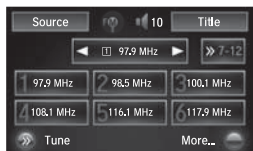

To listen to a stored channel, select 1-6 (AM) or 1-12 (FM).

BACK Button

Press to go back to the previous display.

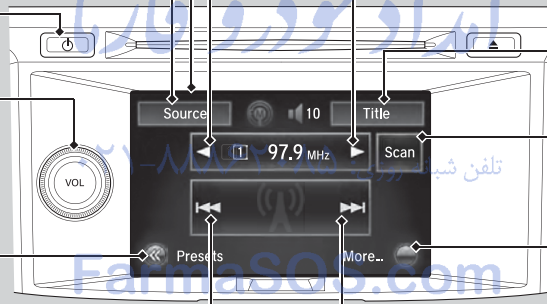

Tune Up/Down Icons

Select ◀ or ▶ to tune the radio frequency.

Title

Select to display the information of the current station.

Scan

Select to sample each of the strongest stations on the selected band for 10 seconds.

More

Select to display the menu items.

Skip/Seek Icons

Select ◀◀ or ▶▶ to search up and down the selected band for a station with a strong signal.

MENU Button

Press to display the menu items.

Interface Dial/ENTER Button

Press and turn to tune the radio frequency.

Move up, down, right and left to select secondary menu.

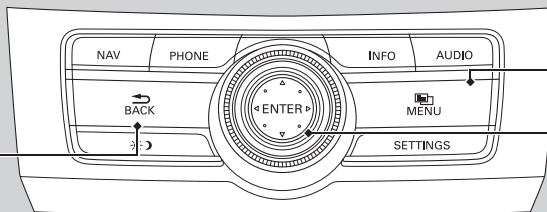





■ Preset Memory

To store a station:

1. Tune to the selected station.

Interface Dial

2. Press the **MENU** button.
3. Rotate  to select **Save Preset**, then press .
4. Rotate  to select the preset number you want to store that station, then press and hold .

Audio with Touch Screen

2. Select **More**.
3. Select **Save Preset**.
4. Select the preset number you want to store that station.

You can also store the station by pressing and holding a preset number.

▶▶ Playing AM/FM Radio

You can control the AM/FM radio using voice commands.

- ▶ **Voice Control Operation** P. 244

The **ST** indicator appears on the display indicating stereo FM broadcasts.

Stereo reproduction in AM is not available.

Switching the Audio Mode

Press the **SOURCE** button on the steering wheel.

- ▶ **Audio Remote Controls** P. 179

You can also switch the mode by pressing the **MENU** button and selecting **Change Source** on the **Audio menu** screen.

You can store 6 AM stations and 12 FM stations into the preset memory.

FarmaSOS.com

Radio Data System (RDS)

Provides text data information related to your selected RDS-capable FM station.

To find an RDS station from Station List



1. Move ◀ or ▶ to select the **Station List** tab.
2. Rotate ⌚ to select the station, then press ⌚.

Manual update

Updates your available station list at any time.

1. Press the **MENU** button while listening to an FM station.
2. Rotate ⌚ to select **Refresh Station List**, then press ⌚.

Radio Data System (RDS)

When you select an RDS-capable FM station, the RDS automatically turns on, and the frequency display changes to the station name. However, when the signals of that station become weak, the display changes from the station name to the frequency.

امداد خودرو فارما

تلفن شبانه روزی: ۰۲۱-۸۸۸۶۲۰۸۵

FarmaSOS.com

■ Radio text

Display the radio text information of the selected RDS station.

1. Press the **MENU** button.
2. Rotate  to select **Radio Text**, then press .

■ Scan

Samples each of the strongest stations on the selected band for 10 seconds.

Interface Dial

1. Press the **MENU** button.
 2. Rotate  to select **Scan**, then press .
- To turn off scan, press  to select **Cancel Scan**, or press the **BACK** button.

Audio with Touch Screen

▶ **Playing AM/FM Radio** P. 252

To turn off scan, select **Stop Scan**.

تلفن شبانه روزی: ۰۲۱-۸۸۸۶۲۰۸۵

FarmaSOS.com

Playing SiriusXM® Radio

Audio/Information Screen

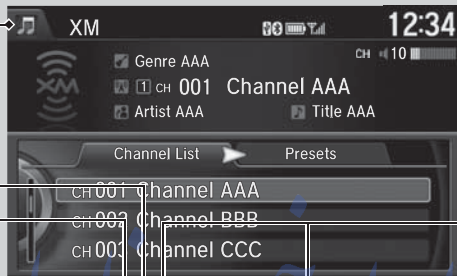

Audio with Touch Screen

Source

Select to change an audio source.

(Power) Button

Press to turn the audio system on and off.

VOL (Volume) Knob

Turn to adjust the volume.

Presets

Select to store a station.



To listen to a stored channel, select 1-12.

BACK Button

Press to go back to the previous display.

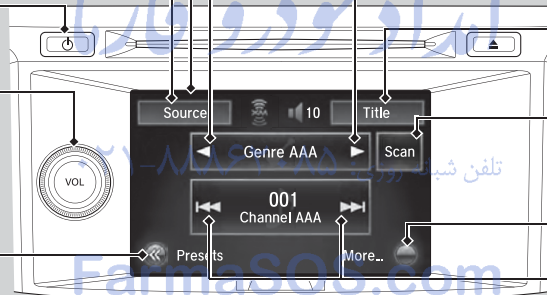

Category Up/Down Icons

Select ◀ or ▶ to display and select an SiriusXM® Radio category.

Title

Select to display the information of the current station.

Scan

Select to sample each of the strongest stations on the selected band for 10 seconds.

More

Select to display the menu items.

Skip/Seek Icons

Select |◀◀ or ▶▶| to the previous or next channel.

In channel mode, select and hold to change the channel rapidly.

MENU Button

Press to display the menu items.

Interface Dial/ENTER Button

Press and turn to tune the radio frequency.



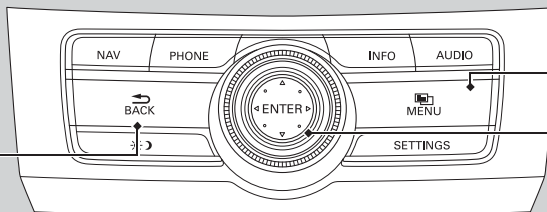





Move up, down, right and left to select secondary menu.







To Play the SiriusXM® Radio

1. Select the SiriusXM® mode.
 - ▶ **Audio Remote Controls** P. 179
 - ▶ **Audio with Touch Screen** P. 236

Interface Dial

2. Press the **MENU** button.
3. Rotate  to select **XM Tune Mode**, then press .
4. Rotate  to select **Channel Mode** or **Category Mode**, then press .
5. Rotate  to select **Channel List**, then press .
6. Rotate  to select a channel from a list, then press .

Audio with Touch Screen

2. Select **More**.
3. Select **Tune Mode**.
4. Select **CH Channel Mode** or **CAT Category Mode**.
5. Select a channel using the , , ,  icons on the tune mode screen or the preset numbers (1-12) on the preset mode screen.

▶▶ Playing SiriusXM® Radio

You can control the SiriusXM® radio using voice commands.

- ▶ **Voice Control Operation** P. 244

In the channel mode, all available channels are selectable. In the category mode, you can select a channel within a category (Jazz, Rock, Classical, etc.).

There may be instances when SiriusXM® Radio does not broadcast all the data fields (artist name, title). This does not indicate a problem with your audio system.





FarmaSOS.com

Preset Memory

To store a station:

1. Tune to the selected station.

Interface Dial

2. Press the **MENU** button.
3. Rotate  to select **Save Preset**, then press .
4. Rotate  to select the preset number you want to store that station, then press and hold .

Audio with Touch Screen

2. Select **More**.
3. Select **Save Preset**.
4. Select the preset number you want to store that station.

You can also store the station by pressing and holding a preset number.

▶▶ Playing SiriusXM® Radio

You can store 12 SiriusXM® stations into the preset memory.

امداد خودرو فارما

تلفن شبانه روزی: ۰۲۱-۸۸۸۶۲۰۸۵

FarmaSOS.com

Playing a CD

Your audio system supports audio CDs, CD-Rs and CD-RWs in either MP3, WMA, or AAC*1 format. With the CD loaded, select the CD mode.

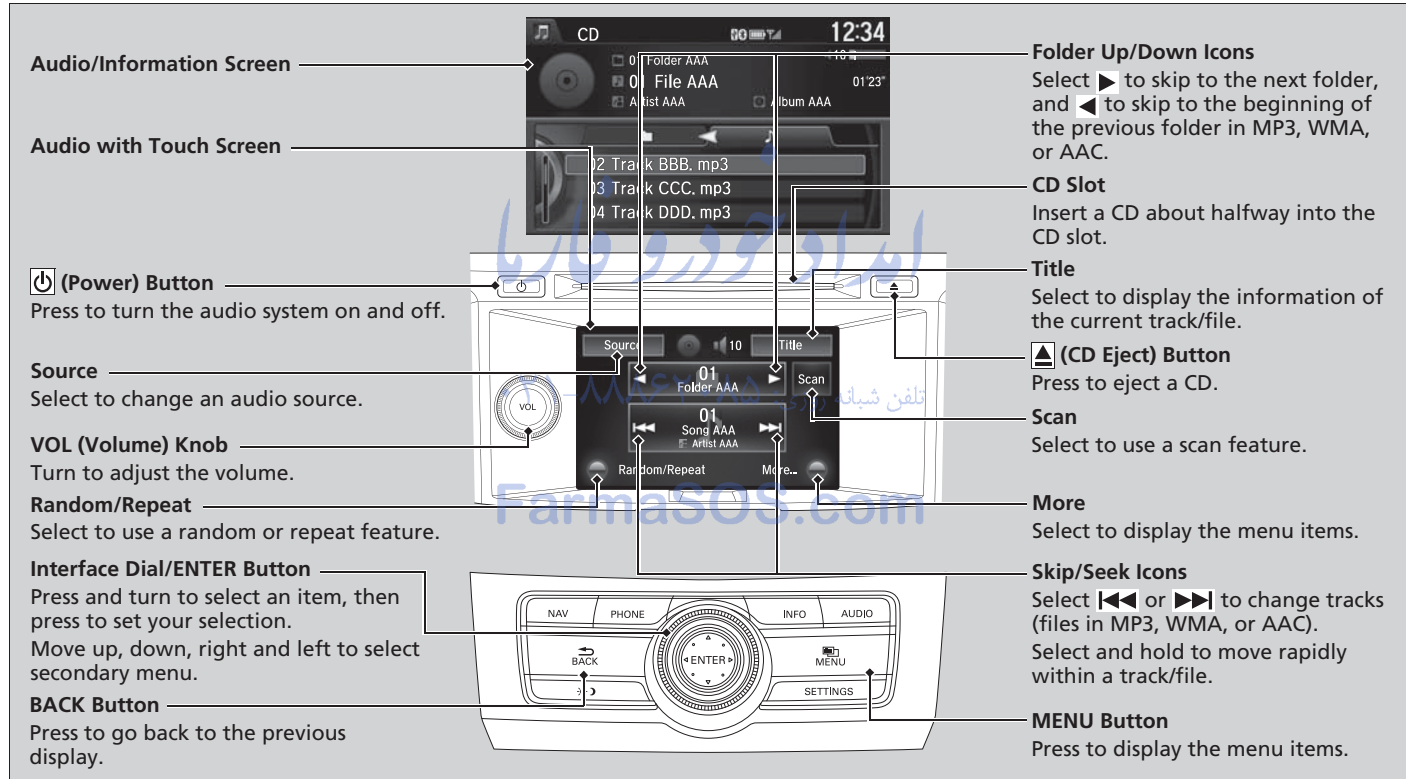

*1: Only AAC format files recorded with iTunes are playable on this unit.

How to Select a File from the Music Search List (MP3/WMA/AAC)

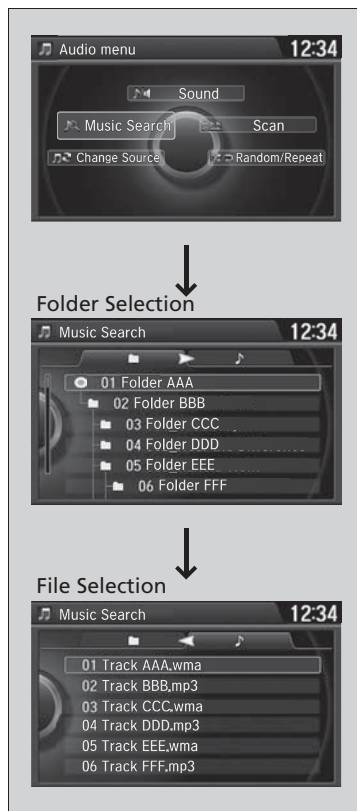

1. Press the **MENU** button.
2. Rotate to select **Music Search**, then press .

3. Rotate , move or , then press to select a file from the **Music Search** list.

▶▶ Playing a CD

NOTICE

Do not use CDs with adhesive labels. The label can cause the CD to jam in the unit.

WMA files protected by digital rights management (DRM) cannot be played.

The audio system displays **Unplayable File**, then skips to the next file.

Text data appears on the display under the following circumstances:

- When you select a new folder, file, or track.
- When you change the audio mode to CD.
- When you insert a CD.

If you eject the CD but do not remove it from the slot, the system reloads the CD automatically after several seconds.

You can control a CD audio using voice commands.

Voice Control Operation P. 244



How to Select a Play Mode

You can select scan, repeat, and random modes when playing a track or file.



To turn off a play mode

Interface Dial

1. Press the **MENU** button.
2. Rotate  to select the mode you want to turn off, then press .

Audio with Touch Screen

1. Select **Scan** or **Random/Repeat**.
▶ **Playing a CD** P. 259
2. Select the mode you want to turn off.

How to Select a Play Mode

Play Mode Menu Items

Scan

Scan Folders (MP3/WMA/AAC): Provides 10-second sampling of the first file in each of the main folders.

Scan Tracks: Provides 10-second sampling of all tracks on the CD (all files in the current folder in MP3, WMA, or AAC).

Random/Repeat

Repeat Folder (MP3/WMA/AAC): Repeats all files in the current folder.

Repeat Track: Repeats the current track/file.

Random in Folder (MP3/WMA/AAC): Plays all files in the current folder in random order.

Random All Tracks: Plays all tracks/files in random order.

تلفن شبانه روزی: ۰۲۱-۸۸۸۶۲۰۸۵

FarmaSOS.com

Playing Hard Disk Drive (HDD) Audio

The Hard Disk Drive (HDD) Audio function plays tracks from music CDs that have been recorded onto the built-in HDD. You can arrange the tracks in playlists or play the tracks using various search methods.

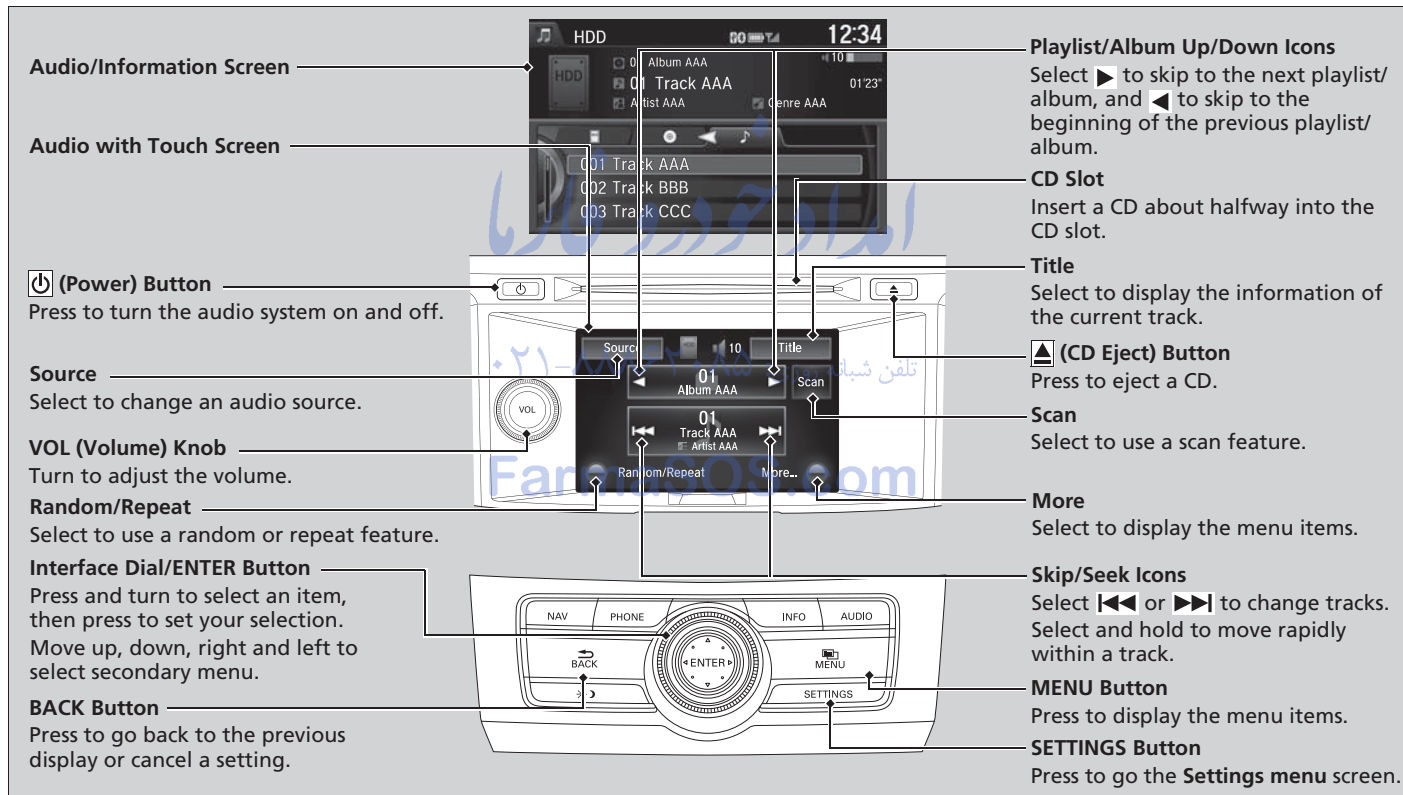

Recording a Music CD to HDD

When **Recording from CD** is set to **Auto**, the songs on music CDs are automatically recorded to the HDD the first time you play each disc. You can then play the songs directly from the HDD.

➤ **Customized Features** P. 298

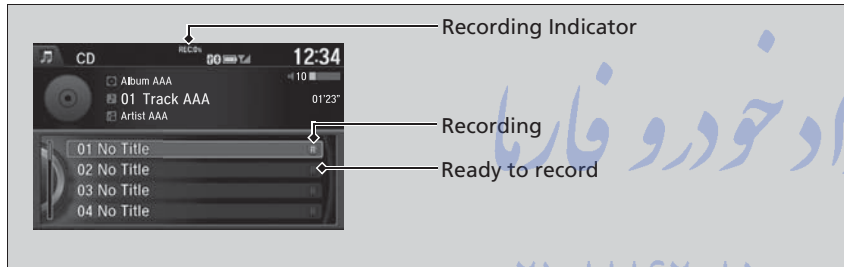

Stop Recording

1. Press the **MENU** button.
2. Rotate to select **Cancel Record to HDD**, then press .

Recording a CD Manually

When **Recording from CD** is set to **Manual**, the songs on music CDs can be manually recorded to the HDD.

1. Press the **MENU** button.
2. Rotate to select **Rec to HDD**, then press .

Recording a Music CD to HDD

You can add tracks to user playlists, where you can mix and match tracks from other CDs recorded on the HDD.

- **Editing an Album or Playlist** P. 266
- **Editing Track Information** P. 269

If you stop the engine or the power system is turned off while recording a CD, there may be pauses between songs when you play back from the HDD.

Repeat, random, and scan functions are not available during recording.

You can play music from other sources (e.g., SiriusXM®, HDD, etc.) while recording.

Please note that there is no compensation offered in the case of unsuccessful recording of audio data or the loss of audio data due to any cause whatsoever.

Clearing the HDD

Any music tracks stored on the HDD can be deleted.

- **Deleting All HDD Data** P. 335

How to Select a Track from the Music Search List

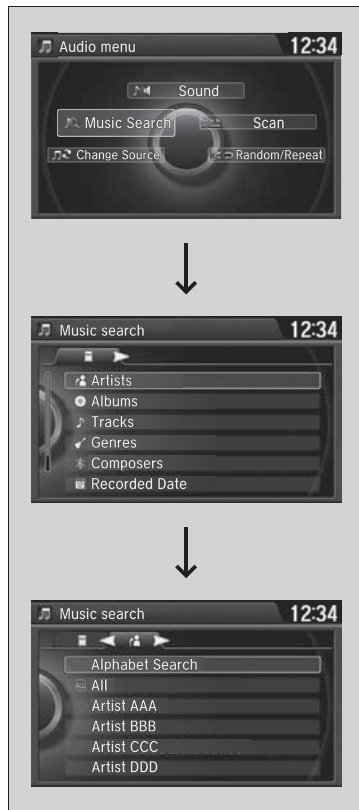

1. Press the **MENU** button.
2. Rotate to select **Music Search**, then press .
3. Rotate , move or , then press to select a track from the **Music Search** list.
 - ▶ Title information is displayed if found in the Gracenote® Album Info (Gracenote® Media Database) stored on the HDD.
 - ▶ The HDD has two types of playlists: original playlists and user playlists. An original playlist is automatically created for each album when a music CD is recorded. You can customize up to six user playlists provided on the HDD by adding tracks from your original playlists.

How to Select a Track from the Music Search List

You can control the HDD audio using voice commands.

- ▶ **Voice Control Operation** P. 244
- ▶ **Song By Voice™ (SBV)** P. 276

Music tracks recorded on HDD cannot be recorded onto CDs or other devices.

Tracks are recorded at four times the playback speed using ultra-efficient compression technology; therefore, sound quality may vary slightly from the original.

If the HDD is ever replaced, all music data is lost and cannot be recovered.

If there is a problem, you may see an error message on the display.

- ▶ **Hard Disk Drive (HDD) Audio** P. 289



FarmaSOS.com

How to Select a Play Mode

You can select scan, repeat, and random modes when playing a track.



Interface Dial

1. Press the **MENU** button.
2. Rotate  to select **Scan** or **Random/Repeat**, then press .
3. Rotate  to select a mode, then press .

Audio with Touch Screen

1. Select **Scan** or **Random/Repeat**.
▶ **Playing Hard Disk Drive (HDD) Audio**
P. 262
2. Select a mode.

How to Select a Play Mode

Play Mode Menu Items

Scan

Scan Albums: Provides 10-second sampling of the first track in each album.

Scan Tracks: Provides 10-second sampling of all tracks on HDD.

Random/Repeat

Repeat Album: Repeats all tracks in the current album.



Repeat Track: Repeats the current track.

Random in Album: Plays all tracks in the current album in random order.

Random All Tracks: Plays all tracks in random order.

To turn off a play mode

Interface Dial

1. Press the **MENU** button.
2. Rotate  to select the mode you want to turn off, then press .

Audio with Touch Screen

1. Select **Scan** or **Random/Repeat**.
▶ **Playing Hard Disk Drive (HDD) Audio** P. 262
2. Select the mode you want to turn off.

تلفن شبانه روزی: ۰۲۱-۸۸۸۶۲۰۸۵

FarmaSOS.com

Editing an Album or Playlist

Change the playlist name, album name, genre, and track order of the current playlist. You can also delete tracks, playlists, and albums.



Editing an album

1. Press the **MENU** button.
2. Rotate to select **Edit/Delete**, then press .
3. Rotate to select **Albums**, then press .
 - ▶ The pop-up menu appears on the screen.
4. To edit an album name:
 - Rotate to select **Edit name**, then press .
 - ▶ Enter the name using the interface dial or the audio with touch screen.

To delete an album:

Rotate to select **Delete**, then press .

To edit track information or delete a track:

Rotate to select **List Tracks**, then press .

▶ **Editing Track Information** P. 269

Editing an Album or Playlist

The maximum number of songs in each of the six user playlists is 999. Adding new songs overwrites the oldest songs.

The maximum number of original playlists is 999 with a maximum of 99 songs in each playlist.

Each album CD counts as an original playlist. Adding a track from a user playlist into the same user playlist will cause the track to appear twice in the playlist.

Deleting an album (original playlist) also deletes the album tracks you have stored in any user playlists.





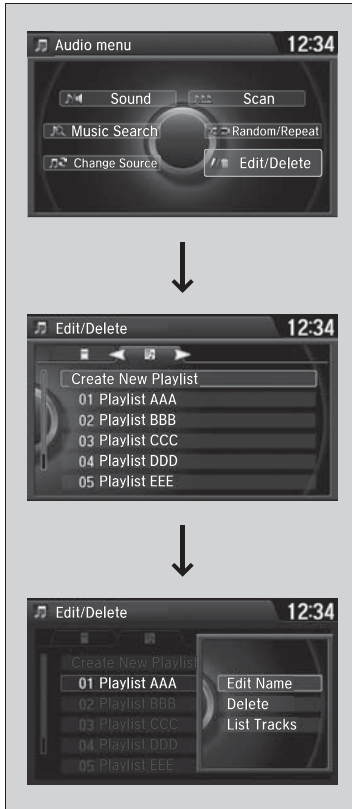

Deleting a user playlist or deleting all tracks from a user playlist does not remove the playlist folder. The folder retains the playlist name and artist information.



Select **[?%A]** to enter symbols.



■ Editing a playlist

1. Press the **MENU** button.
2. Rotate  to select **Edit/Delete**, then press .
3. Rotate  to select **Playlists**, then press .
 - ▶ The pop-up menu appears on the screen.
4. To edit a playlist name:
 - Rotate  to select **Edit name**, then press .
 - ▶ Enter the name using the interface dial or the audio with touch screen.

To delete a playlist:

Rotate  to select **Delete**, then press .





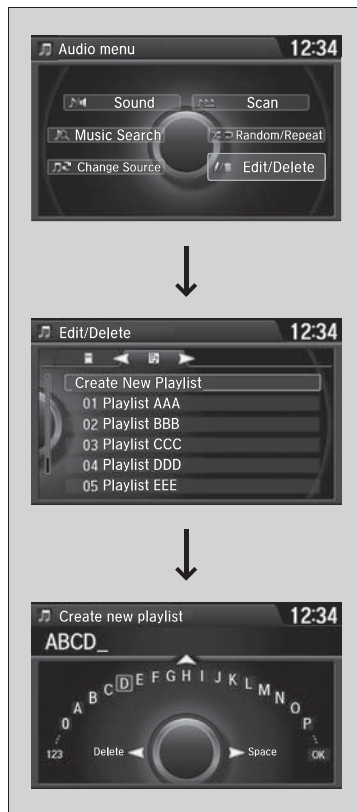

To edit track information or delete a track:

Rotate  to select **List Tracks**, then press .

▶ **Editing Track Information** P. 269



■ Creating a new playlist

1. Press the **MENU** button.
2. Rotate  to select **Edit/Delete**, then press .
3. Rotate  to select **Playlists**, then press .
4. Rotate  to select **Create New Playlist**, then press .
 - ▶ Enter the name using the interface dial or the audio with touch screen, then select tracks from the **Music Search** list.

تلفن شبانه روزی: ۰۲۱-۸۸۸۶۲۰۸۵

FarmaSOS.com

■ Editing Track Information

Change the track title, artist name, genre and composer. You can also delete tracks.













1. Press the **MENU** button.
2. Rotate to select **Edit/Delete**, then press .
3. Rotate to select **Tracks**, then press .
4. Rotate to select a track you want to edit or delete, then press .
 - ▶ The pop-up menu appears on the screen.
5. To edit track information:
 - ▶ Rotate to select **Edit name**, then press .
 - ▶ Enter the track name, track artist, etc. using the interface dial or the audio with touch screen. Move , rotate to select **OK**, then press .

To delete a track:
 Rotate to select **Delete**, then press .

■ Displaying Music Information

Music information (album name, artist name, genre) can be acquired by accessing the Gracenote® Album Info.



1. Press the **MENU** button.
2. Rotate  to select **Edit/Delete**, then press .
3. Rotate  to select **Albums**, then press .
4. Rotate  to select an album you want to edit, then press .
 - ▶ The pop-up menu appears on the screen.
5. Rotate  to select **Edit name**, then press .
6. Move  to select **Get Music Info**, then press .
 - ▶ The system starts to access the تلفن شبانه روزی: ۰۲۱ ۸۸۶۲۰۸۸ Gracenote® Album Info.

FarmaSOS.com

Updating Gracenote® Album Info

Update the Gracenote® Album Info (Gracenote® Media Database) that is included with the navigation system.



1. Insert the update disc into the disc slot or connect the USB flash drive that includes the update.
2. Press the **SETTINGS** button in the **HDD** mode.
3. Rotate to select **Audio Settings**, then press .
4. Move or to select the **CD/HDD** tab.
5. Rotate to select **Update Gracenote Album Info**, then press .
6. Rotate to select **Update by USB** or **Update by CD**, then press .
 - ▶ The system starts updating and the confirmation message appears on the screen. Press to finish.

Updating Gracenote® Album Info

To acquire updated files:

- Consult a dealer.
- U.S.: Visit automobiles.honda.com.
- Canada: Visit www.hondanavi.ca.

Once you perform an update, any information you edited before will be overwritten or erased.

Playing an iPod

Connect the iPod using your dock connector to the USB port, then select the iPod mode.

📖 **USB Port** P. 175

The diagram illustrates the audio system's interface for playing an iPod. It is divided into three main sections: the iPod screen, the main audio display, and the physical control panel.

- iPod Screen:** Shows the 'iPod' source selected. It displays album art, song title '01 Song AAA', artist 'Artist AAA', and genre 'Genre AAA'. A 'USB Indicator' is shown in the top right corner.
- Main Audio Display:** Features a 'Source' button, a track counter '10', and a 'Title' button. The current track '01 Song AAA' by 'Artist AAA' is shown with album art. Below the track are 'Shuffle/Repeat' and 'More...' options.
- Physical Control Panel:** Includes a 'NAV' button, 'PHONE' button, 'INFO' button, 'AUDIO' button, a central 'ENTER' button, 'BACK' and 'MENU' buttons, and a 'SETTINGS' button.

Audio/Information Screen — Points to the iPod screen.

Album Art — Points to the album art on the iPod screen.

Audio with Touch Screen — Points to the main audio display.

Source — Select to change an audio source.

(Power) Button — Press to turn the audio system on and off.

Album Art Icon — Points to the album art icon on the main display.

VOL (Volume) Knob — Turn to adjust the volume.

Shuffle/Repeat — Select to use a shuffle or repeat feature.

Interface Dial/ENTER Button — Press and turn to select an item, then press to set your selection. Move up, down, right and left to select secondary menu.

BACK Button — Press to go back to the previous display.

USB Indicator — Appears when an iPod is connected.

Album Bar — Select to search for an album.

Title — Select to display the information of the current song.

Play/Pause Icon — Select to resume or play a song.

More — Select to display the menu items.

Skip/Seek Icons — Select |◀◀ or ▶▶| to change songs. Select and hold to move rapidly within a song.

MENU Button — Press to display the menu items.

How to Select an Album

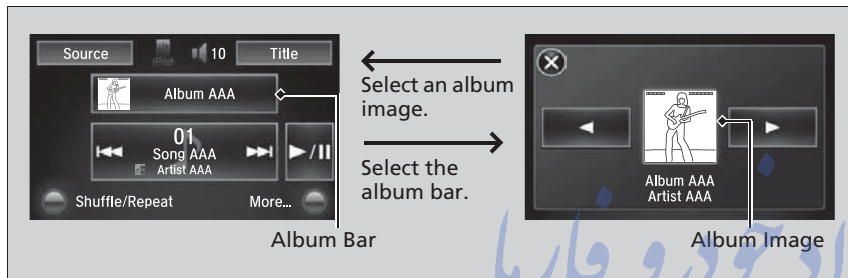

1. Select the album bar.
 - ▶ The image of the current album is displayed.
2. Select ◀ or ▶ icon to search for an album.
 - ▶ When the album image you are looking for appears, select it to play.

FarmaSOS.com

How to Select an Album

You cannot select an album while the vehicle is moving.

Select to go back to the previous screen.

How to Select a Song from the Music Search List



1. Press the **MENU** button.
2. Rotate to select **Music Search**, then press .

3. Rotate , move or , then press to select a song from the **Music Search** list.

How to Select a Song from the Music Search List

You can control an iPod using voice commands.

- **Voice Control Operation** P. 244
- **Song By Voice™ (SBV)** P. 276

Available operating functions vary on models or versions. Some functions may not be available on the vehicle's audio system.

If there is a problem, you may see an error message on the audio/information screen.

- **iPod/USB Flash Drive** P. 290

امداد خودرو فارما

تلفن شبانه روزی: ۰۲۱-۸۸۸۶۲۰۸۵





FarmaSOS.com

How to Select a Play Mode



You can select repeat and shuffle modes when playing a file.

Interface Dial

1. Press the **MENU** button.
2. Rotate  to select **Shuffle/Repeat**, then press .
3. Rotate  to select a mode, then press .

Audio with Touch Screen

1. Select **Shuffle/Repeat**.
▶ **Playing an iPod** P. 272
2. Select a mode.

How to Select a Play Mode

Play Mode Menu Items

Repeat Song: Repeats the current track.

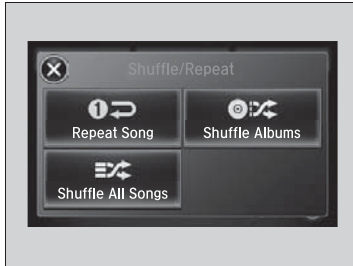

Shuffle Albums: Plays all available albums in a selected list (playlists, artists, albums, songs, genres, or composers) in random order.

Shuffle All Songs: Plays all available files in a selected list (playlists, artists, albums, songs, genres, or composers) in random order.



To turn off a play mode

Interface Dial

1. Press the **MENU** button.
2. Rotate  to select the mode you want to turn off, then press .

Audio with Touch Screen

1. Select **Shuffle/Repeat**.
▶ **Playing an iPod** P. 272
2. Select the mode you want to turn off.

FarmaSOS.com

Song By Voice™ (SBV)

Use SBV to search for and play music from your HDD or iPod using voice commands.

■ To enable SBV

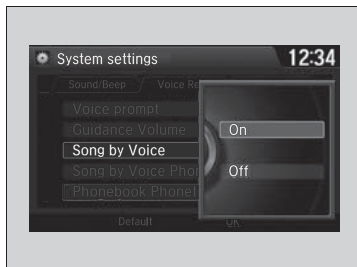

1. Press the **SETTINGS** button.
2. Rotate to select **System Settings**, then press .
3. Move or to select the **Voice Reco** tab.
4. Rotate to select **Song by Voice**, then press .
5. Rotate to select **On** or **Off**, then press .



▣ Song By Voice™ (SBV)

Setting options:

- **On** (factory default): Song By Voice commands are available.
- **Off**: Disable the feature.

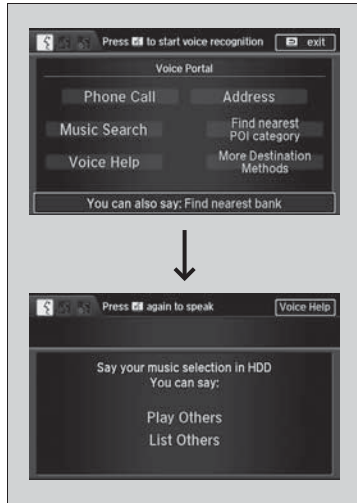
■ Searching for music using SBV



1. Press the  (Talk) button and say "Music Search" to activate the SBV feature for the HDD and iPod.
2. Press the  button and say a command.
 - ▶ Example 1: Say "(List) 'Artist A'" to view a list of songs by that artist. Select the desired song to start playing.
 - ▶ Example 2: Say "Play 'Artist A'" to start playing songs by that artist.
3. To cancel SBV, press the  (hang-up/back) button on the steering wheel. The selected song continues playing.

Once you have canceled this mode, you need to press the  button and say "Music Search" تلفن شب again to re-activate this mode.

FarmaSOS.com

▶▶ Searching for music using SBV

Song By Voice™ Commands List

▶ **Song By Voice™ commands** P. 246

NOTE:

Song By Voice™ commands are available for tracks stored on the HDD or iPod.

You can add phonetic modifications of difficult words so that it is easier for SBV to recognize artists, songs, albums, and composers in voice commands.

▶ **Phonetic Modification** P. 278

Phonetic Modification

Add phonetic modifications of difficult or foreign words so that it is easier for SBV to recognize artists, songs, albums, and composers in voice commands when searching for music on the HDD or iPod.



1. Press the **SETTINGS** button.
2. Rotate to select **System Settings**, then press .
3. Move or to select the **Voice Reco** tab.
4. Rotate to select **Song by Voice Phonetic Modification**, then press .
5. Move and rotate to select **New Modification**, then press .
6. Rotate to select **HDD** or **iPod**, then press .

Phonetic Modification

Phonetic Modification is grayed out when Song By Voice is set to **Off**.

You can store up to 2,000 phonetic modification items.

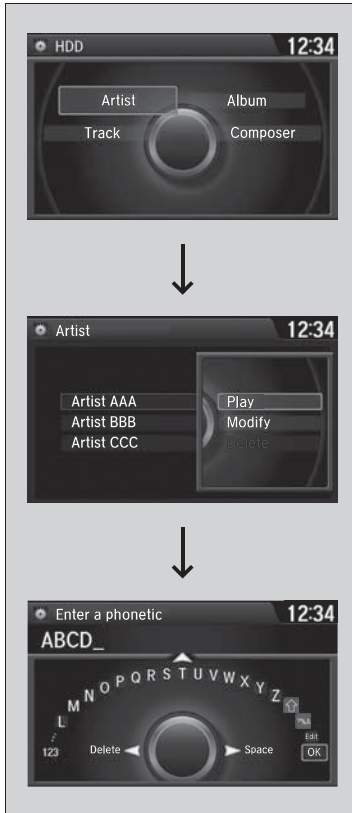

7. Rotate to select the item to modify (e.g., **Artist**), then press .
 - ▶ The list of the selected item appears on the screen.
8. Rotate to select an entry (e.g., **No Name**), then press .
 - ▶ The pop-up menu appears on the screen.
 - ▶ To listen to the current phonetic modification, rotate to select **Play**, then press .
 - ▶ To delete the current phonetic modification, rotate to select **Delete**, then press .
9. Rotate to select **Modify**, then press .
10. Enter the phonetic spelling you wish to use (e.g., "Artist A") when prompted.
11. Move to select **OK** to exit.
 - ▶ The artist "No Name" is phonetically modified to "Artist A." When in the SBV mode, you can press the (Talk) button and use the voice command "Play 'Artist A'" to play songs by the artist "No Name."

Compatible phones only

Playing Internet Radio

Connect a compatible phone through *Bluetooth*®.

iPhone

You can also connect the phone using your dock connector to the USB port. Select **Source** to select Pandora or Aha mode.

▶▶ Playing Internet Radio

Pandora®, the Pandora logo, and the Pandora trade dress are trademarks or registered trademarks of Pandora Media, Inc., used with permission. Pandora is currently available exclusively in the United States.

To find out if your phone is compatible with this feature, visit www.handsfreelink.honda.com, or call 1-888-528-7876.

To use this service in your vehicle, the Pandora® app must first be installed on your phone. Visit www.pandora.com for more information.

The diagram shows the car's audio system interface with callouts for various features:

- Audio/Information Screen**: Points to the top display area showing Pandora station and song information.
- Album Art**: Points to the album art display area.
- Audio with Touch Screen**: Points to the touch-sensitive control area.
- Source**: Points to the Source button on the touch screen.
- (Power) Button**: Points to the power button on the physical control panel.
- VOL (Volume) Knob**: Points to the volume knob on the physical control panel.
- Play/Pause Icon**: Points to the play/pause icon on the touch screen.
- BACK Button**: Points to the back button on the physical control panel.
- Interface Dial/ENTER Button**: Points to the central dial/enter button on the physical control panel.
- USB Indicator**: Points to the USB indicator light on the physical control panel.
- Rating Icon**: Points to the rating icon on the touch screen.
- Title**: Points to the title display area on the touch screen.
- Station Up/Down Icons**: Points to the station up/down icons on the touch screen.
- Skip Icon**: Points to the skip icon on the touch screen.
- More**: Points to the more options icon on the touch screen.
- Like/Dislike Icons**: Points to the like/dislike icons on the touch screen.

Pandora® Menu *



You can operate some of the Pandora® menu items from your vehicle's audio system. The available items are:



- **Skip Forward**
- **Play/Pause**
- **Station List**
- **Like** (Thumbs-up)
- **Dislike** (Thumbs-down)
- **Bookmark This Song**
- **Bookmark This Artist**
- **Change Source**
- **Sound**

Operating a menu item



The menu items are shown in the lower half of the audio/information screen.

Rotate  to select an item and press .

To select **Change Source** or **Sound**, press the **MENU** button, rotate  to select an item, then press .

▶▶ Playing Internet Radio

Pandora® is free, personalized radio that plays music and comedy you'll love. Just start with the name of one of your favorite artists, songs, comedians or composers and Pandora® will create a custom station that plays similar tracks. Pandora® also features hundreds of genre stations ranging from Dubstep to Smooth Jazz to Power Workout.

If you cannot operate Pandora® through the audio system, it may be streaming through *Bluetooth®* Audio. Make sure Pandora® mode on your audio system is selected.

Changing Stations

To change stations, activate the Pandora® menu, select **Station List**, and then select a new station.

▶▶ Pandora® Menu *

You can control Pandora® using voice commands.

▶ **Voice Control Operation** P. 244

Available operating functions vary on software versions. Some functions may not be available on the vehicle's audio system.

If there is a problem, you may see an error message on the audio/information screen.

▶ **Pandora®** P. 291

Pandora® may limit the total number of skips allowed on the service. If you dislike a track after the skip limit has been reached, your feedback will be saved but the current track will continue to play.

* Not available on all models

Aha™ Radio Menu

You can operate some of the Aha™ menu items from your vehicle's audio system. The available items are:

- Like
- Dislike
- Play/Pause
- 15sec Back
- 30sec Skip
- Sound
- View text
- View list
- Reply
- Change Source
- Stations

Operating a menu item

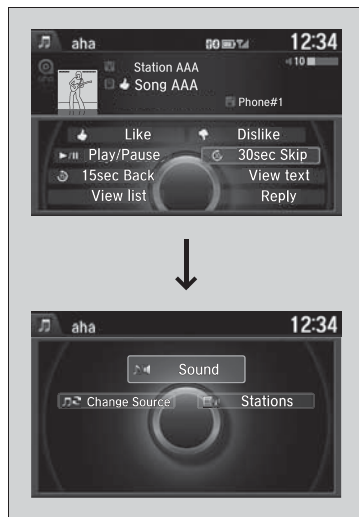

The menu items are shown in the lower half of the audio/information screen.

Rotate to select an item and press .

To select **Sound**, **Change Source** or **Stations**, press the **MENU** button, rotate to select an item, then press .

Aha™ Radio Menu

Aha™ by Harman is a cloud-based service that organizes your favorite web content into live radio stations. You can access podcasts, internet radio, location-based services, and audio updates from social media sites.

You can control Aha™ Radio using voice commands.

Voice Control Operation P. 244

Available operating functions vary on software versions. Some functions may not be available on the vehicle's audio system.

If there is a problem, you may see an error message on the audio/information screen.

Aha™ Radio* P. 293

The menu items vary depending on the station you selected.

To use this service in your vehicle, the HondaLink app must be installed on your phone. Visit owners.honda.com/apps for more information.

You must have a previously set up Aha account prior to using the service in your vehicle. Visit www.aharadio.com for more information.

Playing a USB Flash Drive

Your audio system reads and plays sound files on a USB flash drive in either MP3, WMA, or AAC*1 format.

Connect your USB flash drive to the USB port, then select the USB mode.

➤ **USB Port** P. 175

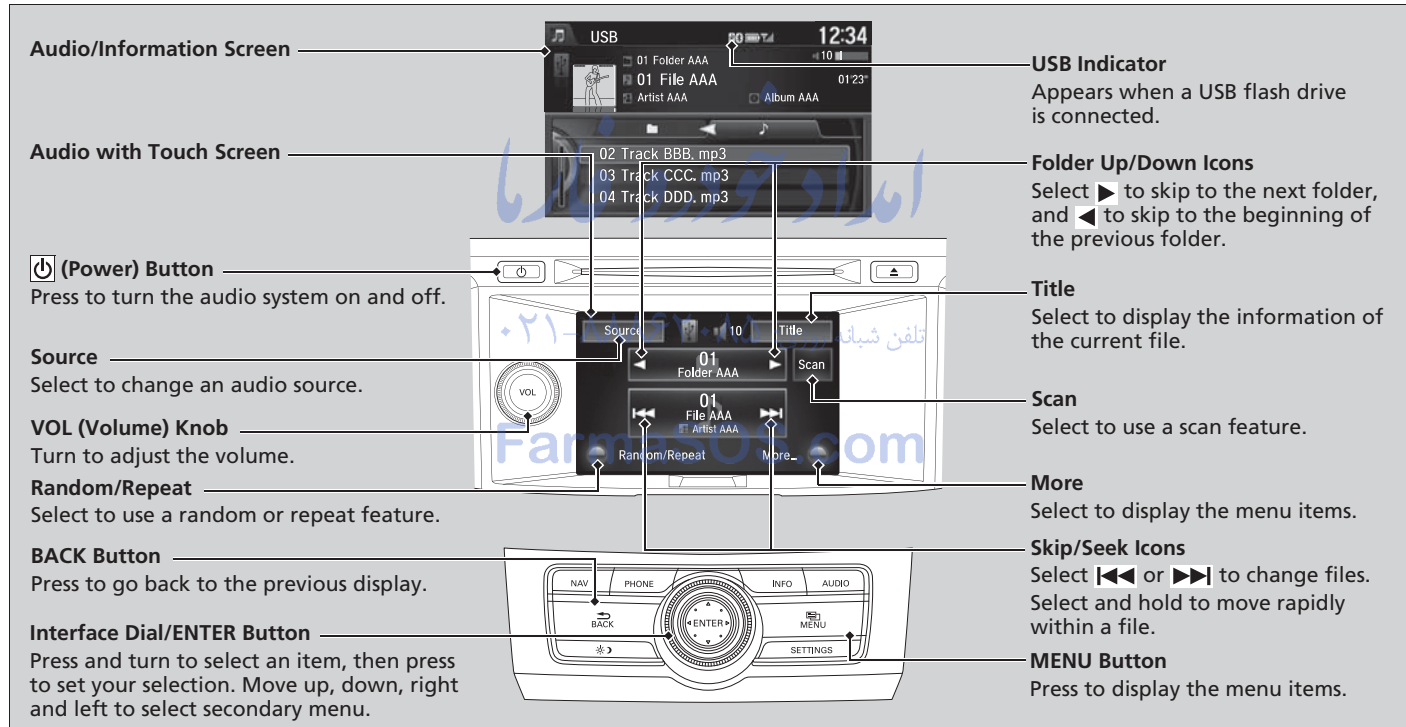

*1: Only AAC format files recorded with iTunes are playable on this unit.

How to Select a File from the Music Search List

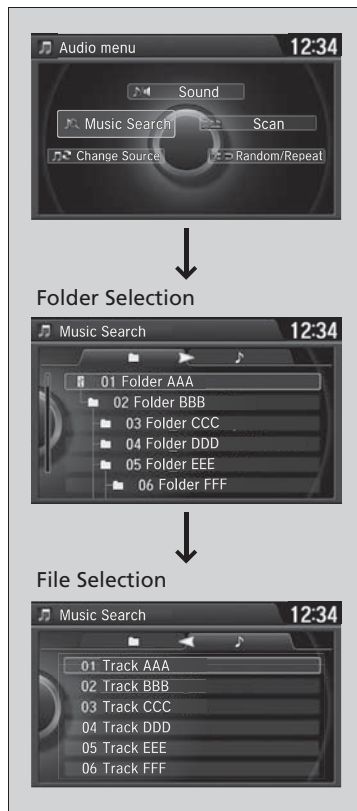

1. Press the **MENU** button.
2. Rotate  to select **Music Search**, then press .

3. Rotate , move  or , then press  to select a file from the **Music Search** list.

▶▶ Playing a USB Flash Drive

You can control a USB flash drive using voice commands.

▶ **Voice Control Operation** P. 244

Use the recommended USB flash drives.

▶ **General Information on the Audio System**
P. 294

Files in WMA format protected by digital rights management (DRM) cannot be played.

The audio system displays **Unplayable File**, and then skips to the next file.

If there is a problem, you may see an error message on the audio/information screen.

▶ **iPod/USB Flash Drive** P. 290

امداد خودرو فارما

تلفن شبانه روزی: ۰۲۱-۸۸۸۶۲۰۸۵

FarmaSOS.com

How to Select a Play Mode

You can select scan, repeat, and random modes when playing a file.



Interface Dial



1. Press the **MENU** button.
2. Rotate  to select **Scan** or **Random/Repeat**, then press .
3. Rotate  to select a mode, then press .

Audio with Touch Screen

1. Select **Scan** or **Random/Repeat**.
▶ **Playing a USB Flash Drive** P. 283
2. Select a mode.

To turn off a play mode

Interface Dial

1. Press the **MENU** button.
2. Rotate  to select the mode you want to turn off, then press .

Audio with Touch Screen

1. Select **Scan** or **Random/Repeat**.
▶ **Playing a USB Flash Drive** P. 283
2. Select the mode you want to turn off.

How to Select a Play Mode

Play Mode Menu Items

Scan

Scan Folders: Provides 10-second sampling of the first file in each of the main folders.

Scan Tracks: Provides 10-second sampling of all files in the current folder.

Random/Repeat

Repeat Folder: Repeats all files in the current folder.

Repeat Track: Repeats the current file.

Random in Folder: Plays all files in the current folder in random order.

Random All Tracks: Plays all files in random order.

تلفن شبانه روزی: ۰۲۱-۸۸۸۶۲۰۸۵

FarmaSOS.com

Playing *Bluetooth*® Audio

Your audio system allows you to listen to music from your *Bluetooth*-compatible phone.

This function is available when the phone is paired and connected to the vehicle's *Bluetooth*® HandsFreeLink® (HFL) system.

➤ **Phone Setup** P. 381

▶▶ Playing *Bluetooth*® Audio

Not all *Bluetooth*-enabled phones with streaming audio capabilities are compatible with the system.

For a list of compatible phones:

- U.S.: Visit www.handsfreelink.honda.com, or call 1-888-528-7876.
- Canada: Visit www.handsfreelink.ca, or call 1-888-528-7876.

In some states, it may be illegal to perform some data device functions while driving.

If more than one phone is paired to the HFL system, there will be a delay before the system begins to play.

You can control *Bluetooth*® Audio using voice commands.

➤ **Voice Control Operation** P. 244

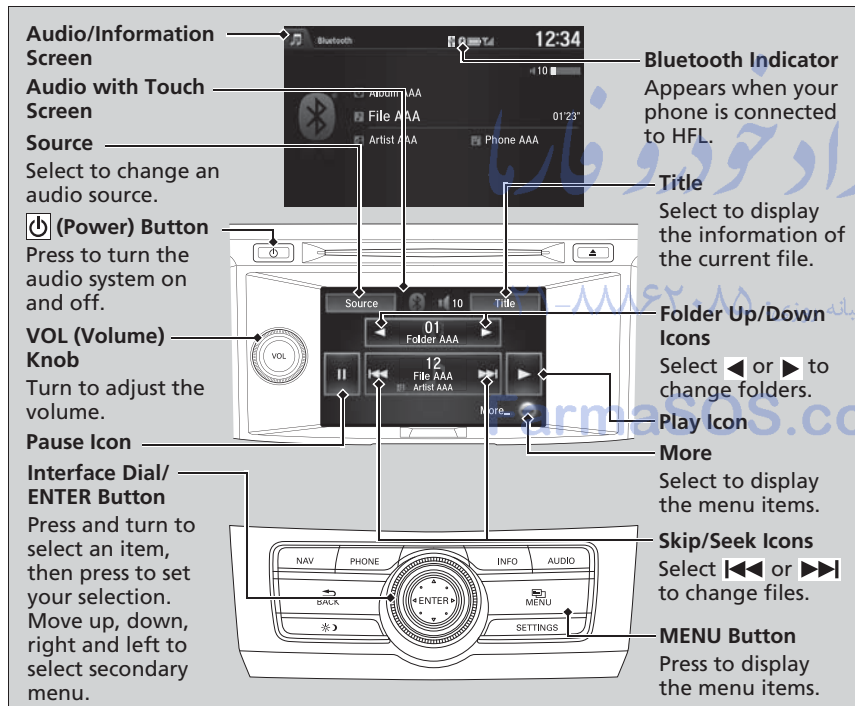

To Play *Bluetooth*® Audio Files

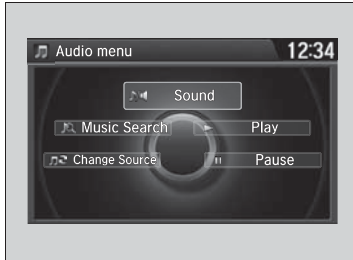

1. Make sure that your phone is paired and connected to HFL.
2. Select the *Bluetooth*® Audio mode.

If the phone is not recognized, another HFL-compatible phone, which is not compatible for *Bluetooth*® Audio, may already be connected.

To Play *Bluetooth*® Audio Files



To play the audio files, you may need to operate your phone. If so, follow the phone maker's operating instructions.

The pause function may not be available on some phones.

Switching to another mode pauses the music playing from your phone.

To pause or resume a file

Interface Dial

1. Press the **MENU** button.
2. Rotate  to select **Play** or **Pause**, then press . تلفن شبانه روزی: ۰۸۵-۱۸۸۶۲۰۸۵





Audio with Touch Screen

Select the play icon or pause icon.

FarmaSOS.com

CD Player

If a disc error occurs, you may see the following error messages.

Error Message	Cause	Solution
Unplayable File	Track/file format not supported	<ul style="list-style-type: none"> Current track/file will be skipped. The next supported track/file plays automatically.
Bad Disc Please Check Owner's Manual Push Eject	Mechanical error	<ul style="list-style-type: none"> Press the  (eject) button and remove the disc, and check that the error message is cleared. Check that the disc is not damaged or deformed, and insert the disc again.
Mecha Error		<ul style="list-style-type: none">  Protecting CDs P. 296
Bad Disc Please Check Owner's Manual	Servo error	<ul style="list-style-type: none"> If the error message reappears, press the  button, and pull out the disc. Insert a different disc. If the new disc plays, there is a problem with the first disc. If the error message repeats, or the disc cannot be removed, contact a dealer. Do not try to force the disc out of the player.
Check Disc	Disc error	<ul style="list-style-type: none"> Check that the disc is not damaged or deformed.  Protecting CDs P. 296
Heat Error	High temperature	<ul style="list-style-type: none"> Turn the audio system off and allow the player to cool down until the error message is cleared.

Models with navigation system

Hard Disk Drive (HDD) Audio

If an error occurs while playing the Hard Disk Drive (HDD) Audio, you may see the following error messages. If you cannot clear the error message, contact a dealer.

Error Message	Solution
HDD access error. Please consult your dealer.	—
The navigation system temperature is too high. For protection, the system will shut off until it cools down.	Turn the audio system off and allow the player to cool down until the error message is cleared.
The navigation system temperature is too low. For protection, the system will shut off until it warms up.	The navigation system has difficulty reading the HDD when the temperature is below approximately -22°F (-30°C). The navigation system starts up automatically when the display warms up.
Unplayable File	Appears when a file format not supported. Current track will be skipped. The next supported track plays automatically.

FarmaSOS.com

iPod/USB Flash Drive

If an error occurs while playing an iPod or USB flash drive, you may see the following error messages. If you cannot clear the error message, contact a dealer.

Error Message	Solution
USB Error	Appears when there is a problem with the USB adapter unit. Check if the device is compatible with the USB adapter unit.
Incompatible USB Device Please Check Owner's Manual	Appears when an incompatible device is connected. Disconnect the device. Then turn the audio system off, and turn it on again. Do not reconnect the device that caused the error.
Unsupported Version	Appears when an unsupported iPod is connected. If it appears when a supported iPod is connected, update the iPod software to the newer version.
Connect Retry	Appears when the system does not acknowledge the iPod. Reconnect the iPod.
Unplayable File	Appears when the files in the USB flash drive are DRM or an unsupported format. This error message appears for about 3 seconds, then plays the next song.
No Data	<p>iPod Appears when the iPod is empty.</p> <p>USB flash drive Appears when the USB flash drive is empty or there are no MP3, WMA, or AAC files in the USB flash drive.</p> <p>iPod and USB flash drive Check that compatible files are stored on the device.</p>
Unsupported	Appears when an unsupported device is connected. If it appears when a supported device is connected, reconnect the device.

U.S. models

Pandora®

If an error occurs while playing Pandora®, you may see the following error messages. If you cannot clear the error message, contact a dealer.

Error Message	Solution
Incompatible USB Device Please Check Owner's Manual	Appears when an incompatible device is connected. Disconnect the device. Then turn the audio system off, and turn it again. Do not reconnect the device that caused the error.
<div style="border: 1px solid black; padding: 2px; margin-bottom: 5px;">Audio/Information Screen</div> There is no station list in the device. Please add the station list to your device.	Appears when there is no station list on the device. Use the device to create a station.
<div style="border: 1px solid black; padding: 2px; margin-bottom: 5px;">Audio with Touch Screen</div> No stations have been created. Please create a station on the device.	
Music licenses force us to limit the number of tracks you may skip each hour.	Appears when you try to skip a song or select Dislike over the predetermined number of times in an hour.

FarmaSOS.com

Error Message	Solution
Unable to save rating. Unable to save bookmark or Unable to skip	Appears when the commanded operation is failed. Try again later.
No data	Appears when no data is available with Pandora® activated. Reboot the app and reconnect the device.
PANDORA ver unsupported	Appears when Pandora® version is not supported. Update Pandora® to the latest version.
PANDORA system maintenance	Appears when the Pandora® server is in maintenance. Try again later.
Cannot connect to PANDORA when stopped. Check your mobile phone	Appears when Pandora® is unable to play music. Check your device. <small>تلفن شبانه روز</small>

Aha™ Radio *

If an error occurs while playing Aha™ Radio, you may see the following error messages.

If you cannot clear the error message, contact a dealer.

Error Message	Solution
Cannot connect to HondaLink. When stopped, check your mobile device.	Appears when the Aha™ app is not activated. Check your device.
Incompatible USB Device Please Check Owner's Manual	Appears when an incompatible device is connected. Disconnect the device. Then turn the audio system off, and turn it on again. Do not reconnect the device that caused the error.

تلفن شبانه روزی: ۰۲۱-۸۸۶۲۰۸۵

FarmaSOS.com

SiriusXM® Radio Service*

Subscribing to SiriusXM® Radio

1. You need your radio ID ready before registering for subscription. To see the ID in the display: Turn the selector knob or the interface dial until **0** appears.
2. Have your radio ID and credit card number ready, and either call or visit the SiriusXM® website to subscribe.

Receiving SiriusXM® Radio

Switch to the SiriusXM® mode by using the **SOURCE** button, or through the audio with touch screen, and stay in this mode for about 30 minutes until the service is activated. Make sure your vehicle is in an open area with good reception.

SiriusXM® Radio Display Messages

Loading:

SiriusXM® is loading the audio or program information.

Ch off air:

The channel is not currently broadcasting.

Ch unauthorized:

SiriusXM® radio is receiving information update from the network.

No signal:

The signal is too weak in the current location.

Ch unavailable:

No such channel exists, the channel is not part of your subscription, or the artist or title information is unavailable.

Check antenna:

There is a problem with the SiriusXM® antenna. Contact a dealer.

Subscribing to SiriusXM® Radio

Contact Information for SiriusXM® Radio:

US: SiriusXM® Radio at www.siriusxm.com or (800) 852-9696

Canada: SiriusXM® Canada at www.xmradio.ca, or (877) 209-0079

Receiving SiriusXM® Radio

The SiriusXM® satellites are in orbit over the equator; therefore, objects south of the vehicle may cause satellite reception interruptions. Satellite signals are more likely to be blocked by tall buildings and mountains the farther north you travel from the equator.

You may experience reception problems under the following circumstances:

- In a location with an obstruction to the south of your vehicle.
- In tunnels
- On the lower level of a multi-tiered road
- Large items carried on the roof rack

Recommended CDs

- Use only high-quality CD-R or CD-RW discs labeled for audio use.
- Use only CD-R or CD-RW discs on which the recordings are closed.
- Play only standard round-shaped CDs.

The CD packages or jackets should have one of these marks.



Also includes:



CDs with MP3, WMA, or AAC files

- Some software files may not allow for audio play or text data display.
- Some versions of MP3, WMA, or AAC formats may be unsupported.

FarmaSOS.com

Recommended CDs

A Dual-disc cannot play on this audio unit. If recorded under certain conditions, a CD-R or CD-RW may not play either.

Manufactured under license under U.S. Patent Nos: 5,956,674; 5,974,380; 6,487,535 & other U.S. and worldwide patents issued & pending. DTS, the Symbol, & DTS and the Symbol together are registered trademarks & DTS 2.0 Channel is a trademark of DTS, Inc. Product includes software. ©DTS, Inc. All Rights Reserved.

■ Protecting CDs

Follow these precautions when handling or storing CDs:

- Store a CD in its case when it is not being played.
- When wiping a CD, use a soft clean cloth from the center to the outside edge.
- Handle a CD by its edge. Never touch either surface.
- Never insert foreign objects into the CD player.
- Keep CDs out of direct sunlight and extreme heat.
- Do not place stabilizer rings or labels on the CD.
- Avoid fingerprints, liquids, and felt-tip pens on the CD.

►► Protecting CDs

NOTICE

Do not insert a damaged CD. It may be stuck inside and damage the audio unit.

Examples:

- Bubbled, wrinkled, labeled, and excessively thick CDs



Bubbled/
Wrinkled



With Label/
Sticker



Using
Printer Label
Kit



Sealed



With Plastic Ring

- Damaged CDs



Chipped/
Cracked



Warped



Burrs

- Poor quality CDs

- Small CDs



3-inch
(8-cm)
CD

Compatible iPod, iPhone, and USB Flash Drives

■ iPod and iPhone Model Compatibility

Model
iPod (5th generation)
iPod classic 80GB/160GB (launch in 2007)
iPod classic 120GB (launch in 2008)
iPod classic 160GB (launch in 2009)
iPod nano (1st to 7th generation) launch in 2012 ^{*1}
iPod nano (1st to 6th generation) launch in 2010 ^{*2}
iPod touch (1st to 5th generation) launch in 2012 ^{*1}
iPod touch (1st to 4th generation) launch in 2010 ^{*2}
iPhone 3G/iPhone 3GS/iPhone 4/iPhone 4S/iPhone 5 ^{*1}
iPhone 3G/iPhone 3GS/iPhone 4/iPhone 4S ^{*2}

*1: Models with one display

*2: Models with two displays or the navigation system

■ USB Flash Drives

- Use a recommended USB flash drive of 256 MB or higher.
- Some digital audio players may not be compatible.
- Some USB flash drives (e.g., a device with security lockout) may not work.
- Some software files may not allow for audio play or text data display.
- Some versions of MP3, WMA, or AAC formats may be unsupported.

☒ iPod and iPhone Model Compatibility

This system may not work with all software versions of these devices.

☒ USB Flash Drives



Files on the USB flash drive are played in their stored order. This order may be different from the order displayed on your PC or device.

Use the audio/information screen to customize certain features.

Models without navigation system

How to customize

Models with one display

While the vehicle is at a complete stop with the ignition switch in ON **II***1, press the **SETTINGS** button, rotate  to select a setting item, and press .

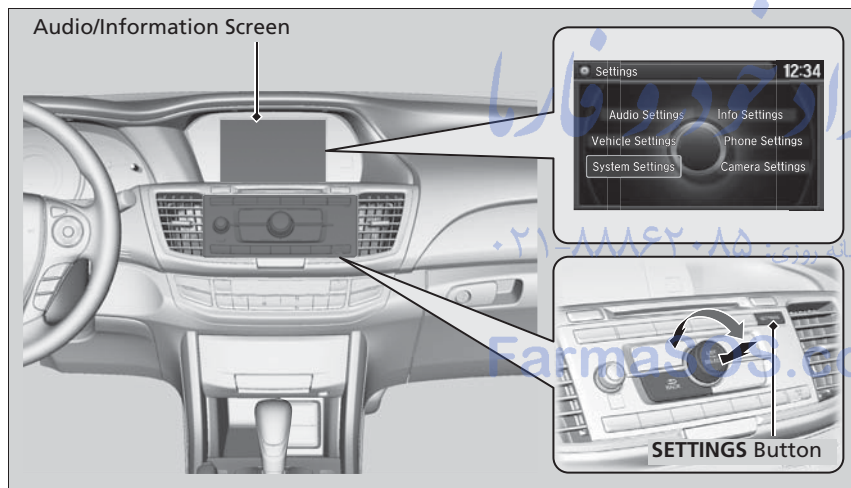

*1: Models with the smart entry system have an **ENGINE START/STOP** button instead of an ignition switch.

Customized Features

When you customize settings:

- Make sure that the vehicle is at a complete stop.

Automatic transmission/CVT models

- Shift to **P**.

Manual transmission models



- Set the parking brake.

How to customize

To customize other features, rotate , and press .

➔ **List of customizable options** P. 305

Models with two displays

While the vehicle is at a complete stop with the power mode in ON, press and hold the **DISP** button, rotate  to select a setting item, and press .

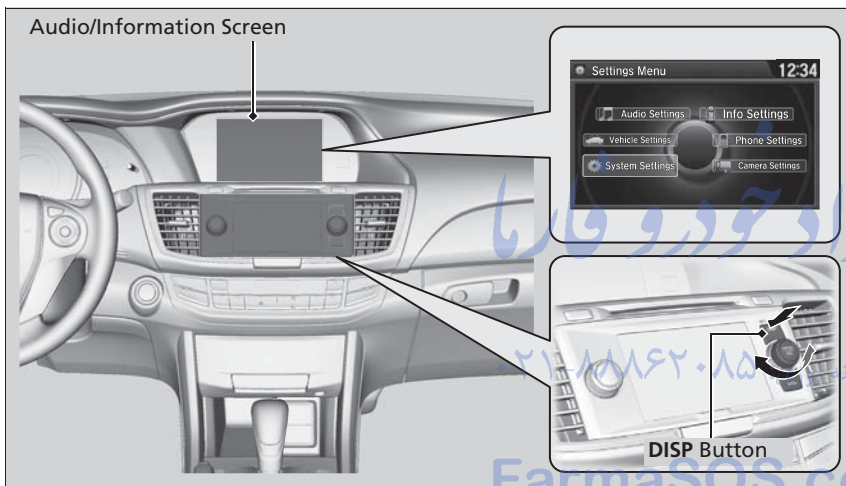

Models without navigation system

■ Customization flow

Models with one display

Press the **SETTINGS** button.

Models with two displays

Press and hold the **DISP** button.



Features

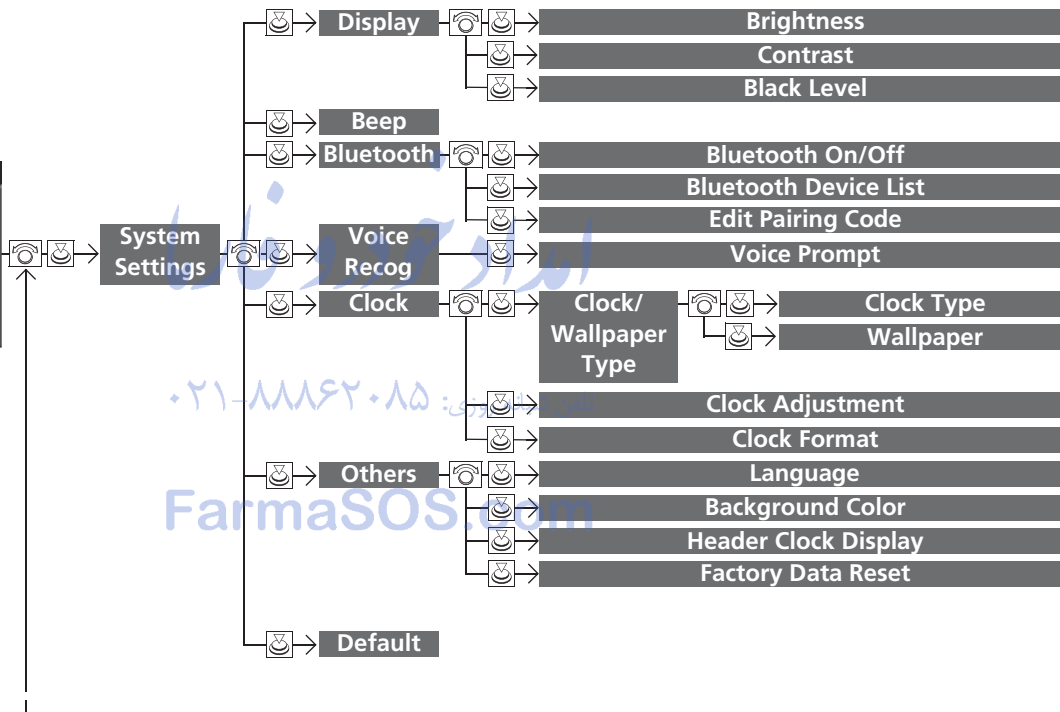

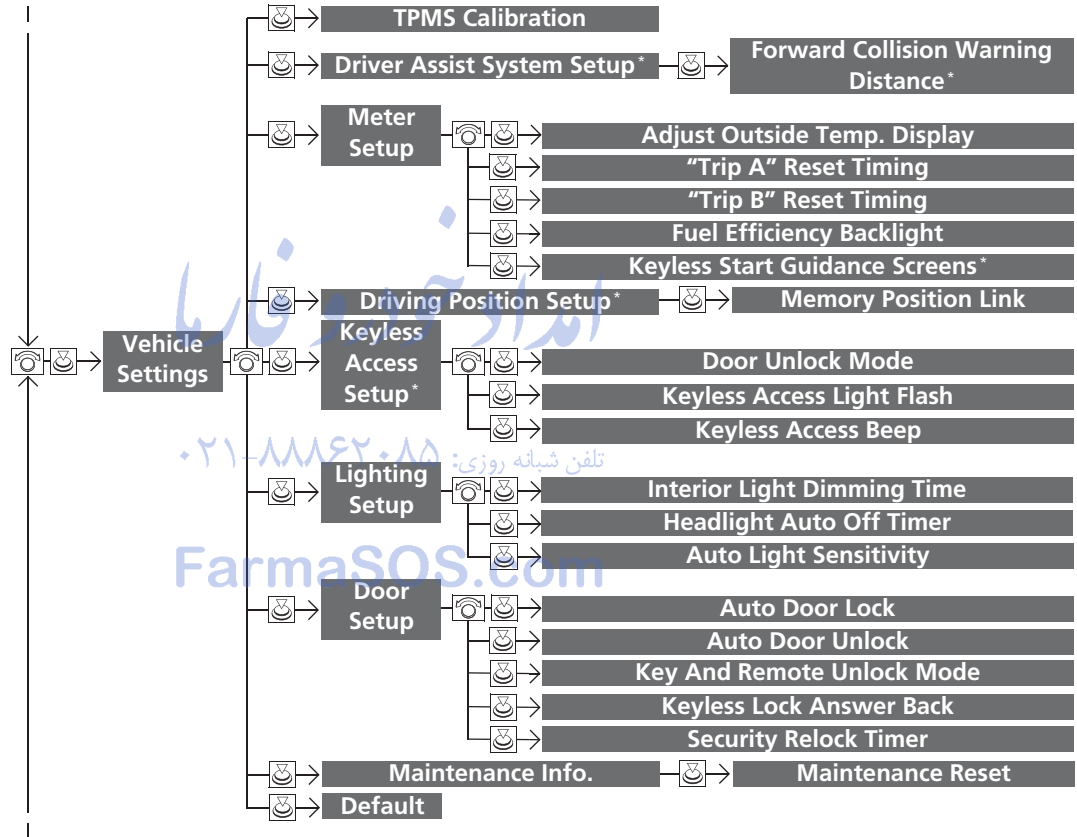

Features

* Not available on all models

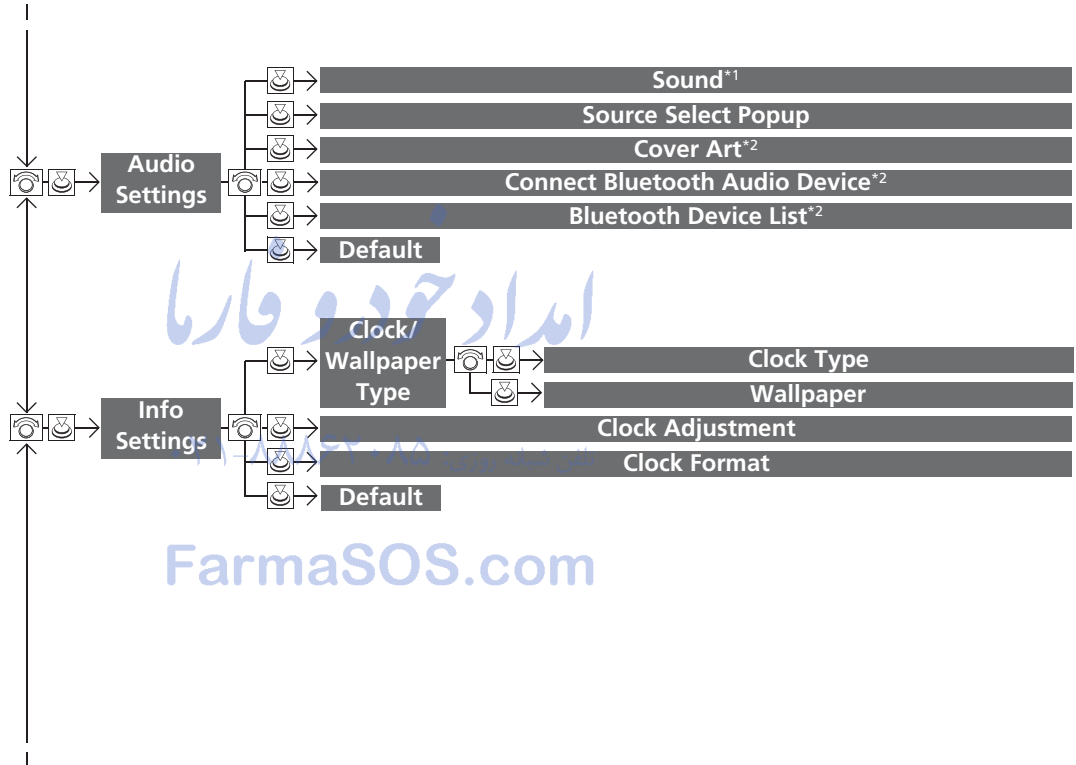

*1: Models with one display

*2: May change depending on your currently selected source.

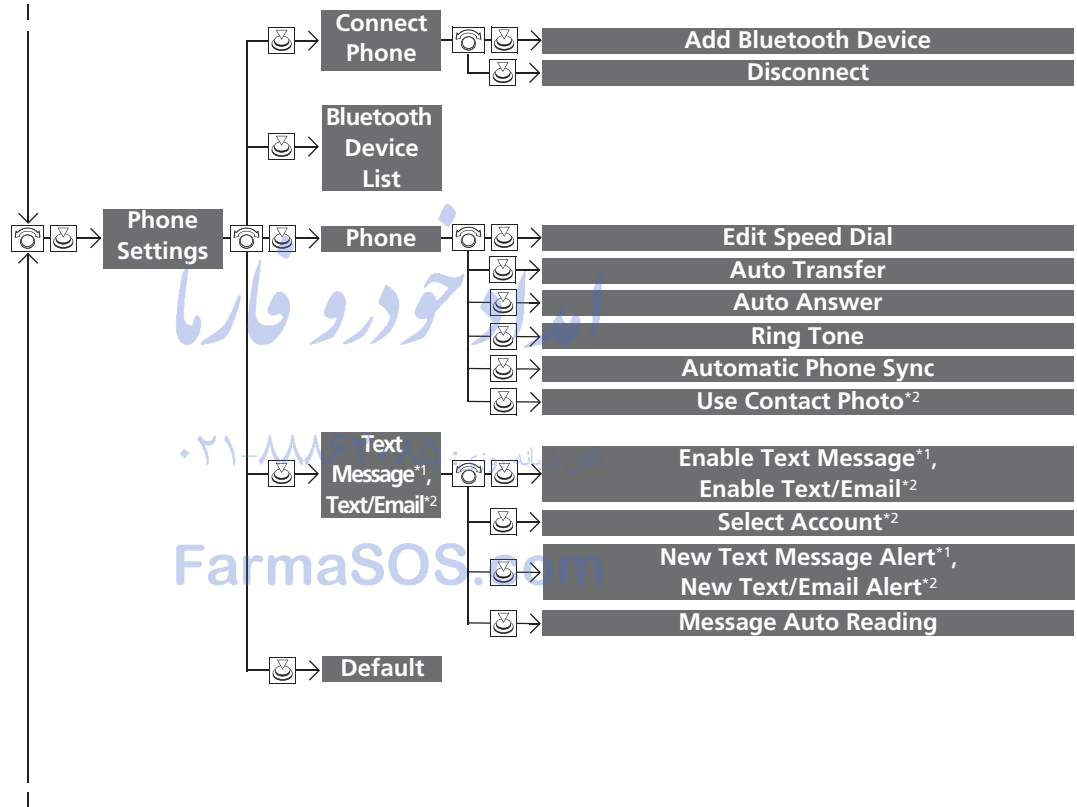

Features

*1: Models with one display
 *2: Models with two displays

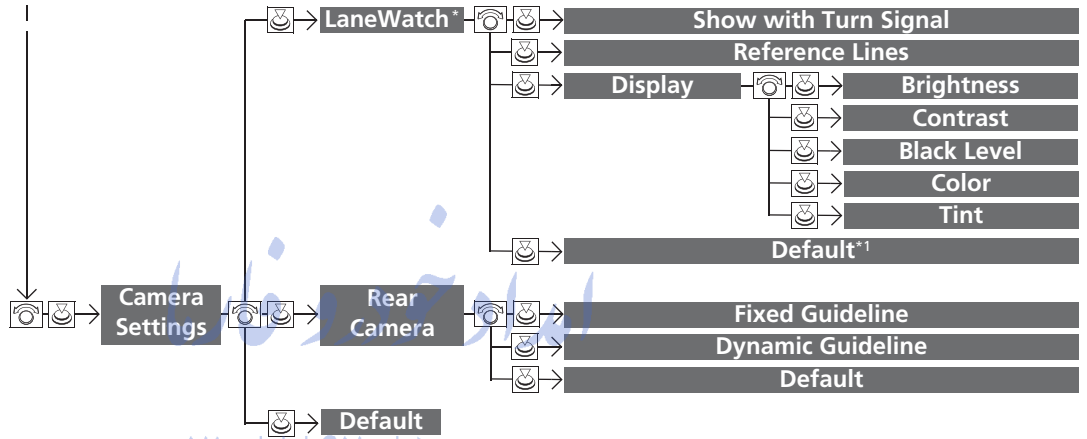

تلفن شبانه روزی: ۰۲۱-۸۸۶۳۰۸۵

FarmaSOS.com

*1: Models with two displays

Models without navigation system

■ List of customizable options

Setup Group	Customizable Features	Description	Selectable Settings	
System Settings	Brightness	Changes the brightness of the audio/information screen.	—	
	Display	Contrast	Changes the contrast of the audio/information screen.	—
		Black Level	Changes the black level of the audio/information screen.	—
		Beep	Selects whether a beeper sounds when you operate the selector knob.	On*¹/Off
	Blue-tooth	Bluetooth On/Off	Turns the <i>Bluetooth</i> ® on and off.	On*¹/Off
		Bluetooth Device List	Pairs a new phone to HFL, edits and deletes a paired phone, and create a security PIN. ☑ Phone Setup P. 346	—
		Edit Pairing Code	Changes a pairing code. ☑ To change the pairing code setting P. 348	Random/Fixed*¹
		Voice Recog	Voice Prompt	Turns the voice prompt on and off.

*1:Default Setting

Setup Group	Customizable Features	Description	Selectable Settings	
System Settings	Clock	Clock Type	Changes the clock display type.	Analog/Digital*¹/ Small Digital/Off
		Clock/ Wallpaper Type	<ul style="list-style-type: none"> Changes the wallpaper type. Imports an image file for a new wallpaper. Deletes an image file for a wallpaper. ➤ Wallpaper Setup P. 183, 209	Blank/Galaxy*¹/ Metallic/Add New
		Wallpaper	Adjusts Clock. ➤ Clock P. 106	—
		Clock Adjustment	Adjusts Clock. ➤ Clock P. 106	—
		Clock Format	Selects the digital clock display from 12H to 24H.	12H*¹/24H
		Language	Changes the display language.	English*¹/French/ Spanish
		Others	Changes the background color of the audio/ information screen and the audio with touch screen*.	Blue*¹/Amber/Red/ Green
		Header Clock Display	Selects whether the clock display comes on.	On*¹/Off
		Factory Data Reset	Resets all the settings to their factory default. ➤ Defaulting All the Settings P. 333	Yes/No
		Default	Cancels/Resets all customized items in the System Settings group as default.	Yes/No

*1:Default Setting

Setup Group	Customizable Features	Description	Selectable Settings	
Vehicle Settings	TPMS Calibration	Cancels/Calibrates the TPMS.	Cancel^{*1}/Calibrate	
	Driver Assist System Setup[*]	Forward Collision Warning Distance[*]	Changes at which distance FCW alerts, or turns FCW on and off.	Long/Normal^{*1}/Short/Off
		Adjust Outside Temp. Display	Adjusts the temperature reading by a few degrees.	-5°F ~ ±0°F^{*1} ~ +5°F (U.S.) -3°C ~ ±0°C^{*1} ~ +3°C (Canada)
	Meter Setup	"Trip A" Reset Timing	Changes the setting of how to reset trip meter A and average fuel economy A.	With Refuel/IGN Off/Manually Reset^{*1}
		"Trip B" Reset Timing	Changes the setting of how to reset trip meter B and average fuel economy B.	With Refuel/IGN Off/Manually Reset^{*1}
		Fuel Efficiency Backlight	Turns the ambient meter feature on and off.	On^{*1}/Off
		Keyless Start Guidance Screens	Displays the push button start guidance when conditions are met to change power mode.	On^{*1}/Off
	Driving Position Setup[*]	Memory Position Link	Changes the driver's seat position to a stored setting.	On^{*1}/Off

*1:Default Setting

* Not available on all models

Setup Group	Customizable Features	Description	Selectable Settings	
Vehicle Settings	Door Unlock Mode	Changes which doors unlock when you grab the driver's door handle.	Driver Door Only^{*1}/ All Doors	
	Keyless Access Setup[*]	Keyless Access Light Flash	Causes some exterior lights to blink when you unlock/lock the doors.	On^{*1}/Off
		Keyless Access Beep	Sets the beeper sound or not when you grab either front door handle.	On^{*1}/Off
		Interior Light Dimming Time	Changes the length of time the interior lights stay on after you close the doors.	60seconds/ 30seconds^{*1}/ 15seconds
	Lighting Setup	Headlight Auto Off Timer	Changes the length of time the exterior lights stay on after you close the driver's door.	60seconds/ 30seconds/ 15seconds^{*1}/ 0seconds
		Auto Light Sensitivity	Changes the timing for the headlights to come on.	Max/High/Mid^{*1}/ Low/Min

*1:Default Setting

Setup Group	Customizable Features	Description	Selectable Settings
Vehicle Settings	Auto Door Lock	Changes the setting for when the doors automatically lock.	With Vehicle Speed*¹/ Shift from P*²/Off
	Auto Door Unlock	Changes the setting for when the doors automatically unlock.	All Doors When Driver's Door Opens*¹/ All Doors When Shifted to Park*²/All Doors When Ignition Switched Off/Off
	Key And Remote Unlock Mode	Sets up either the driver's door or all doors to unlock on the first push of the remote.	Driver Door*¹/All Doors
	Keyless Lock Answer Back	LOCK/UNLOCK- The exterior lights flash. LOCK (2nd push)- The beeper sounds.	On*¹/Off
	Security Relock Timer	Changes the time it takes for the doors to relock and the security system to set after you unlock the vehicle without opening any door.	90seconds/ 60seconds/ 30seconds*¹
	Maintenance Info.	Maintenance Reset	Resets the engine oil life display when you have performed the maintenance service.
	Default	Cancels/Resets all customized items in the Vehicle Settings group as default.	Yes/No

*1:Default Setting

*2:Automatic transmission/CVT models

Setup Group	Customizable Features	Description	Selectable Settings
Audio Settings	Sound*2	Adjusts the settings of the audio speaker's sound. ➤ Adjusting the Sound P. 185	-6 ~ C*1 ~ +6 (Bass, Treble and SUBW*), -9 ~ C*1 ~ +9 (Fader and Balance), Off/Low/Mid*1/High (SVC)
	Source Select Popup	Models with one display Selects whether the list of selectable audio sources comes on when the AUDIO button is pressed. Models with two displays Selects whether the list of selectable audio sources comes on when Audio is selected on the Function Change screen.	On/Off*1
	Cover Art	iPod, USB, Pandora®* or Aha™* mode Turns on and off the cover art display.	On*1/Off
	Connect Bluetooth Audio Device	Bluetooth® Audio, Pandora®* or Aha™* mode Connects, disconnects or pairs a <i>Bluetooth</i> ® Audio device to HFL.	—
	Bluetooth Device List	Bluetooth® Audio, Pandora®* or Aha™* mode Edits or deletes a <i>Bluetooth</i> ® Audio device paired to HFL.	—
	Default	Cancels/Resets all customized items in the Audio Settings group as default.	Yes/No

*1:Default Setting

*2:Models with one display

* Not available on all models

Setup Group	Customizable Features	Description	Selectable Settings
Info Settings	Clock/ Wall- paper type	Clock Type	
		Wallpaper	
	Clock Adjustment		See System Settings on P. 305 to P. 306
	Clock Format		
	Default	Cancels/Resets all customized items in the Info Settings group as default.	Yes/No

تلفن شبانه روزی: ۰۲۱-۸۸۸۶۲۰۸۵

FarmaSOS.com

Setup Group	Customizable Features	Description	Selectable Settings
Phone Settings	Connect Phone	Pairs a new phone to HFL, connects or disconnects a paired phone. ➤ Phone Setup P. 346	—
	Bluetooth Device List	Pairs a new phone to HFL, edits or deletes a paired phone, or creates a security PIN. ➤ Phone Setup P. 346	—
	Edit Speed Dial	Edits, adds or deletes a speed dial entry. ➤ Speed Dial P. 357	—
	Auto Transfer	Sets calls to automatically transfer from your phone to HFL when you enter the vehicle.	On *1/ Off
	Auto Answer	Sets whether to automatically answer an incoming call after about four seconds.	On/Off *1
	Ring Tone	Selects the ring tone.	Fixed/Mobile Phone *1/ Off
	Automatic Phone Sync	Sets a phonebook data to be automatically imported when a phone is paired to HFL.	On *1/ Off
Phone	Use Contact Photo *2	Displays a caller's picture on an incoming call screen.	On *1/ Off

*1:Default Setting

*2:Models with two displays

Setup Group	Customizable Features	Description	Selectable Settings
Phone Settings	Enable Text Message ^{*2} , Enable Text/Email ^{*3}	Turns the text/e-mail message function on and off.	On ^{*1} / Off
	Select Account ^{*3}	Selects a text/e-mail message account.	—
	New Text Message Alert ^{*2} , New Text/Email Alert ^{*3}	Selects whether a pop-up alert comes on the screen when HFL receives a new text/e-mail message.	On/Off ^{*1}
	Message Auto Reading	Sets the system to automatically read an incoming text/e-mail message. <ul style="list-style-type: none"> • On- A text/e-mail message is always read aloud. • Off- A text/e-mail message is not read aloud. • Auto- A text/e-mail message is read aloud only when driving. 	On/Off/Auto ^{*1}
	Default	Cancels/Resets all customized items in the Phone Settings group as default.	Yes/No

*1:Default Setting

*2:Models with one display

*3:Models with two displays

Setup Group	Customizable Features	Description	Selectable Settings		
Camera Settings	Lane-Watch*	Show with Turn Signal	Select whether the LaneWatch display comes on when you move the turn signal lever to the passenger side.	On* ¹ /Off	
		Reference Lines	Selects whether the reference lines come on the LaneWatch monitor.	On* ¹ /Off	
		Display	Brightness	Adjusts the LaneWatch display settings.	—
			Contrast		
			Black Level		
	Color				
	Tint				
	Default ^{*2}	Cancels/Resets all customized items in the LaneWatch group as default.	Yes/No		
	Rear Camera	Fixed Guideline	Selects whether the fixed guidelines come on the rear camera monitor.	On* ¹ /Off	
		Dynamic Guideline	Selects whether the dynamic guidelines come on the rear camera monitor.	On* ¹ /Off	
Default		Cancels/Resets all customized items in the Rear Camera group as default.	Yes/No		
Default	Cancels/Resets all customized items in the Camera Settings group as default.	Yes/No			



*1:Default Setting

*2:Models with two displays

* Not available on all models





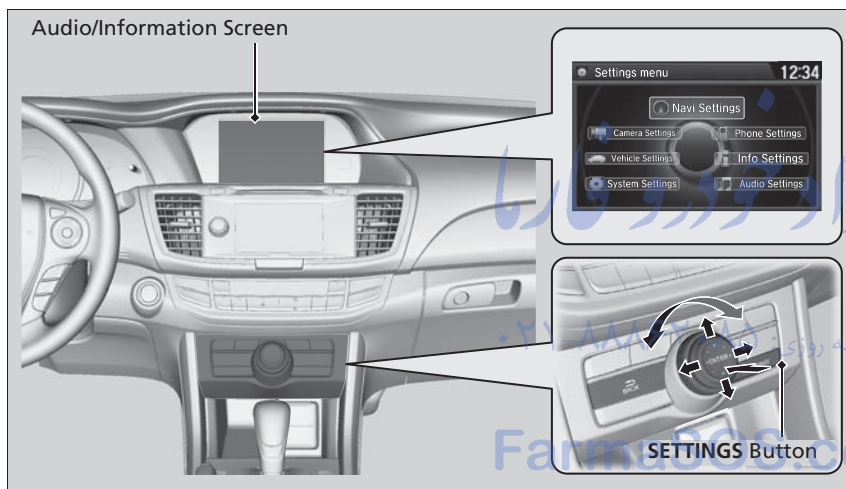

Models with navigation system

■ How to customize

While the vehicle is at a complete stop with the power mode in ON, press the **SETTINGS** button, rotate  to select a setting item, and press .



▶ How to customize

To customize other features, rotate , move , , , , or , and press .

▶ **List of customizable options** P. 322

Models with navigation system

■ Customization flow

Press the **SETTINGS** button.

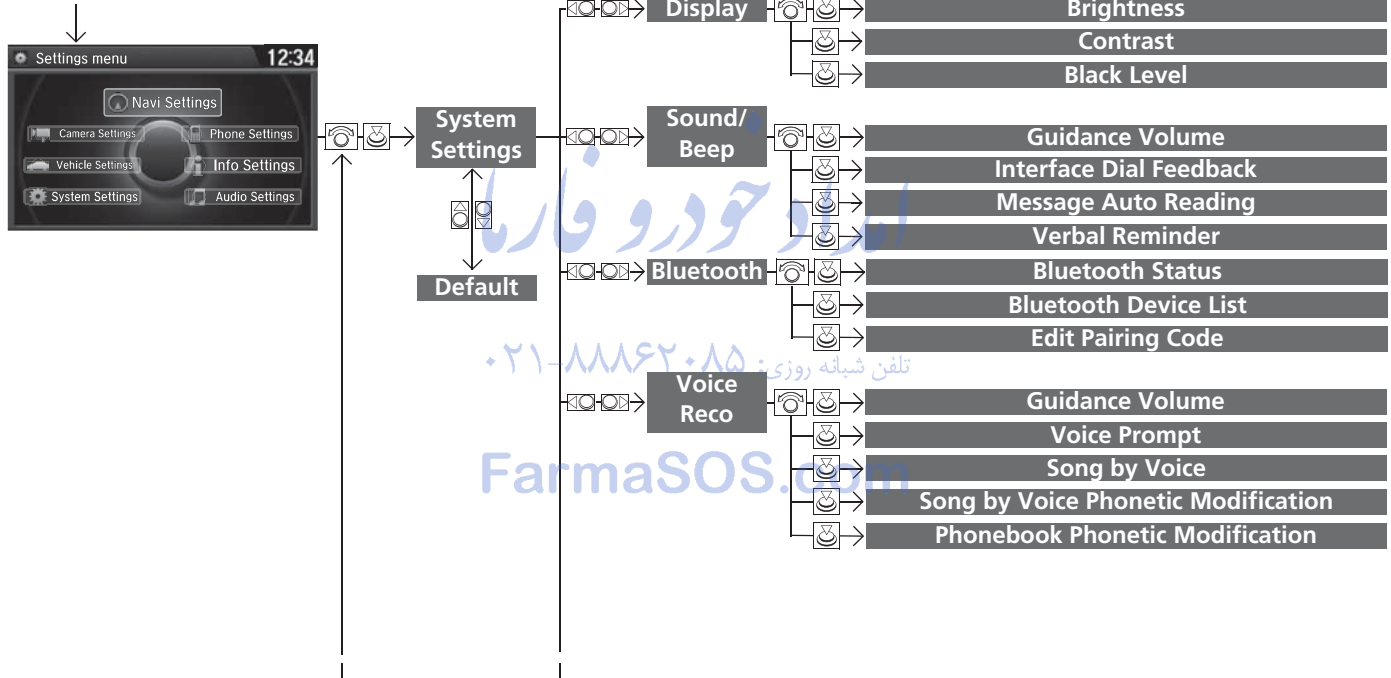

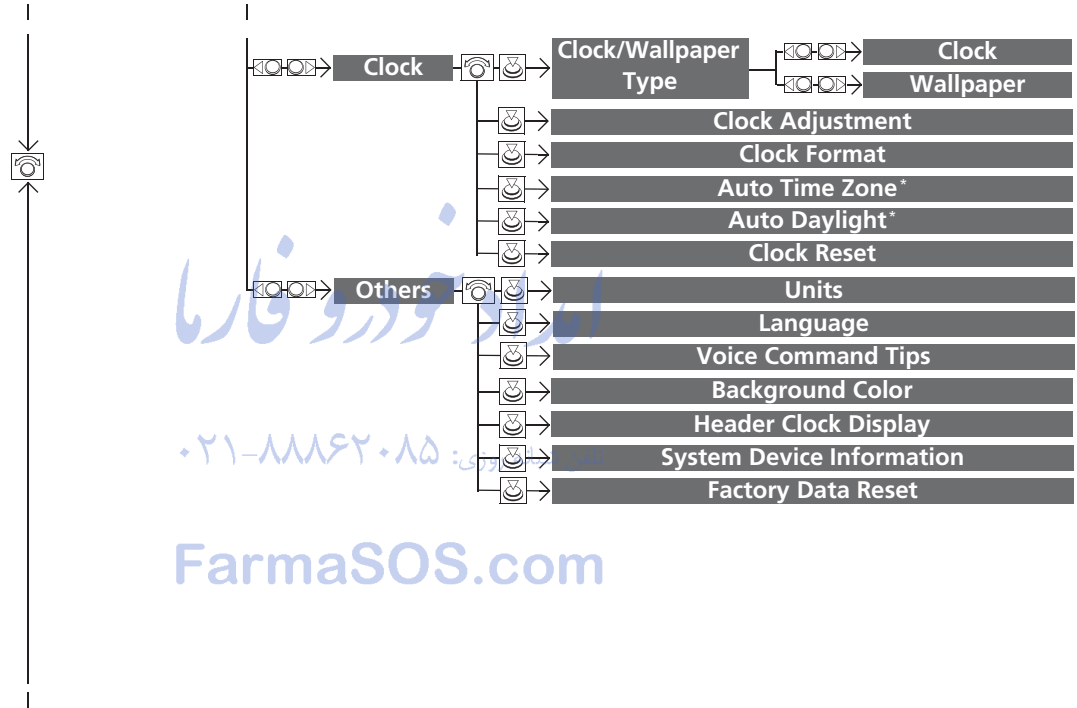

Features

* Not available on all models

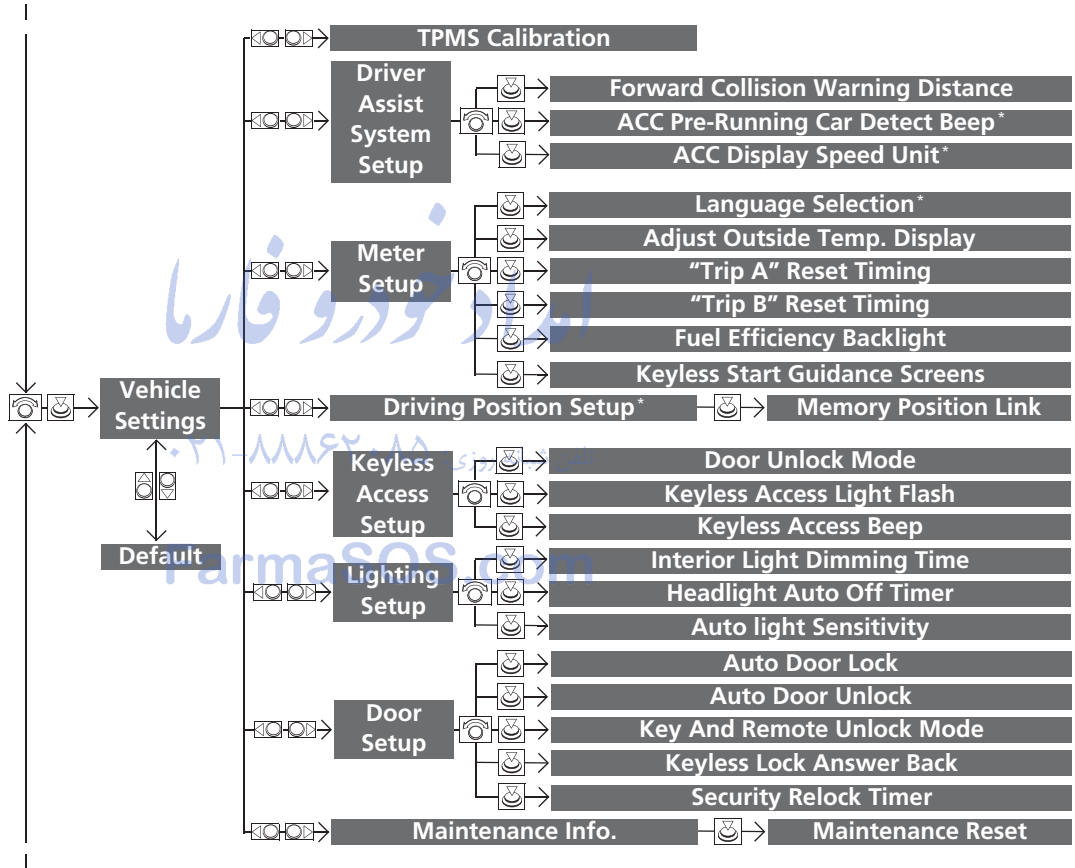

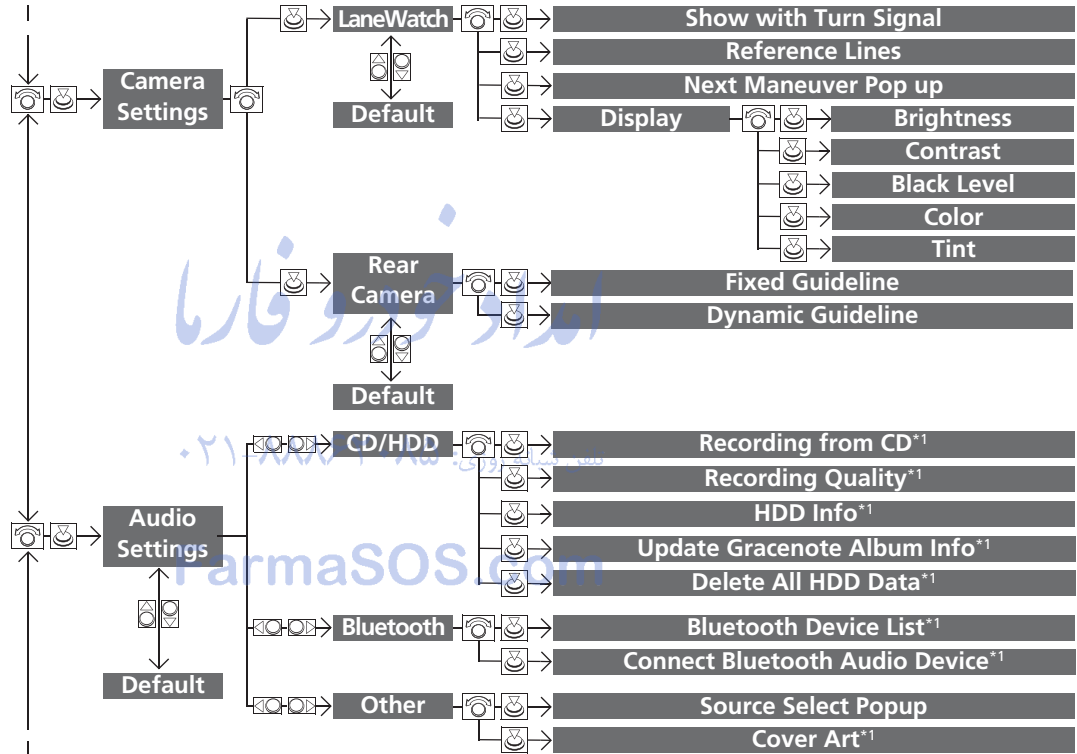

Features

*1: May change depending on your currently selected source.

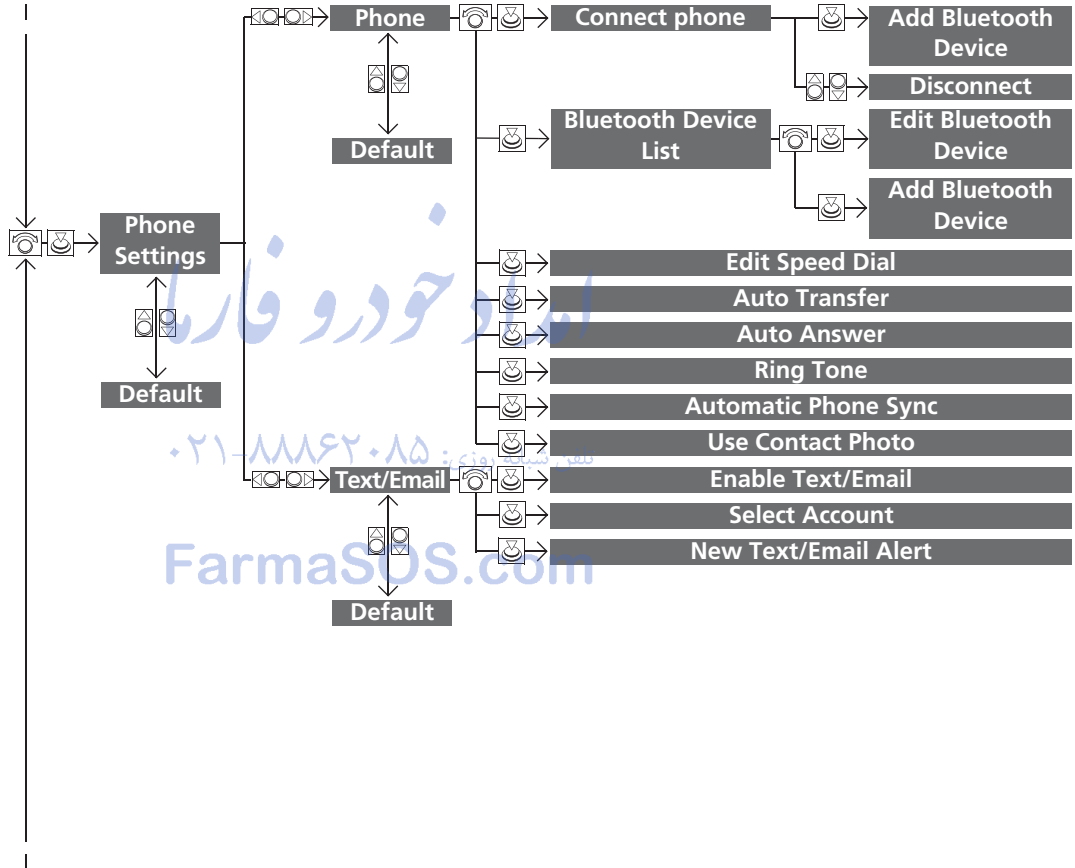

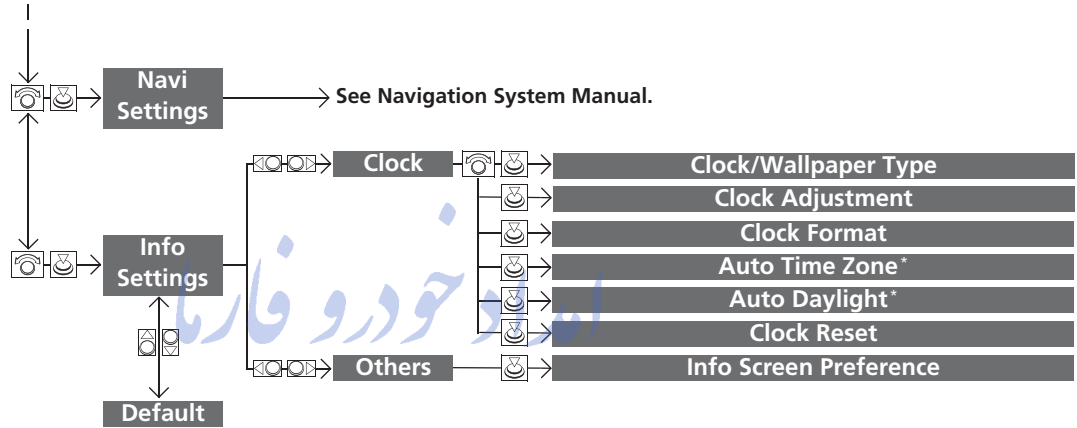

تلفن شبانه روزی: ۰۲۱-۸۸۸۶۲۰۸۵

FarmaSOS.com

Features

* Not available on all models

Models with navigation system

■ List of customizable options

Setup Group	Customizable Features	Description	Selectable Settings	
System Settings	Display	Brightness	Changes the brightness of the audio/information screen.	—
		Contrast	Changes the contrast of the audio/information screen.	—
		Black Level	Changes the black level of the audio/information screen.	—
	Sound/Beep	Guidance Volume	Changes the volume of the audio speakers.	—
		Interface Dial Feedback	Sets if and when the system reads aloud a selection made using the Interface Dial.	On* ¹ /Off/Auto
		Message Auto Reading	Selects whether the system automatically read out message, does not read, or read out only when driving.	On/Off/Auto* ¹
		Verbal Reminder	Turns the verbal reminders on and off.	On* ¹ /Off
	Blue-tooth	Bluetooth Status	Turns the <i>Bluetooth</i> ® on and off.	On* ¹ /Off
		Bluetooth Device List	Pairs a new phone to HFL, edits and deletes a paired phone, and create a security PIN. ➤ Phone Setup P. 381	—
Edit Pairing Code		Changes a pairing code. ➤ To change the pairing code setting P. 383	Random/Fixed* ¹	

*1:Default Setting

Setup Group	Customizable Features	Description	Selectable Settings	
Voice Reco	Guidance Volume	Changes the volume of the voice prompt.	—	
	Voice Prompt	Turns the voice prompt on and off.	On*¹/Off	
	Song by Voice	Turns the Song By Voice™ on and off. ▶ Song By Voice™ (SBV) P. 276	On*¹/Off	
	Song by Voice Phonetic Modification	Modifies a voice command for music stored in the HDD or an iPod. ▶ Phonetic Modification P. 278	—	
	Phonebook Phonetic Modification	Modifies a voice command for the phonebook. ▶ Phonebook Phonetic Modification P. 396	—	
System Settings	Clock/ Wallpaper Type	Clock	Changes the clock display type.	Analog/Digital*¹/ Small Digital/Off
		Wallpaper	<ul style="list-style-type: none"> Changes the wallpaper type. Imports an image file for a new wallpaper. Deletes an image file for a wallpaper. ▶ Wallpaper Setup P. 240	Blank/Galaxy*¹/ Metallic
	Clock	Clock Adjustment	Adjusts Clock. ▶ Clock P. 106	—
		Clock Format	Selects the digital clock display from 12H to 24H.	12H*¹/24H
		Auto Time Zone*	Sets the navigation system to automatically adjust the clock when driving through different time zones.	On*¹/Off

*1: Default Setting

* Not available on all models

Setup Group	Customizable Features	Description	Selectable Settings	
System Settings	Clock	Auto Daylight*	Sets the navigation system to automatically adjust the clock ("spring ahead" or "fall back" by one hour) when a daylight saving time change occurs.	On*¹/Off
		Clock Reset	Resets the settings of all items in the Clock group.	—
		Units	Changes the distance unit on the navigation map screen.	mile*¹/km (U.S.) mile/km*¹ (Canada)
		Language	Changes the display language.	English*¹/French/Spanish
	Others	Voice Command Tips	Alerts you when manual control of the system is disabled to prevent distraction while driving. Only voice commands are available.	On*¹/Off
		Background Color	Changes the background color of the audio/information screen and the audio with touch screen.	Blue*¹/Amber/Red/Green
		Header Clock Display	Selects whether the clock display comes on.	On*¹/Off
		System Device Information	Displays the system/Device information.	—
		Factory Data Reset	Resets all the settings to their factory default.  Defaulting All the Settings P. 334	—
	Default		Cancels /Resets all customized items in the System Settings group as default.	Default/OK

*1:Default Setting

Setup Group	Customizable Features	Description	Selectable Settings	
Vehicle Settings	TPMS Calibration	Cancels/Calibrates the TPMS.	Cancel^{*1}/Calibrate	
	Driver Assist System Setup[*]	Forward Collision Warning Distance	Changes at which distance FCW alerts, or turns FCW on and off.	Long/Normal^{*1}/Short/Off
		ACC Pre-Running Car Detect Beep[*]	Causes the system to beep when the system detects a vehicle, or when the vehicle goes out of ACC range.	On^{*1}/Off
		ACC Display Speed Unit[*]	Changes the speed unit for ACC on the multi-information display [*] .	mph^{*1}/km/h
	Language Selection[*]	Changes the displayed language on the multi-information display [*] .	English^{*1}/French/Spanish	
	Adjust Outside Temp. Display	Adjusts the temperature reading by a few degrees.	-5°F ~ ±0°F^{*1} ~ +5°F (U.S.) -3°C ~ ±0°C^{*1} ~ +3°C (Canada)	
	Meter Setup	"Trip A" Reset Timing	Changes the setting of how to reset trip meter A, average fuel economy A, average speed A [*] , and elapsed time A [*] .	With Refuel/IGN Off/Manually Reset^{*1}
		"Trip B" Reset Timing	Changes the setting of how to reset trip meter B, average fuel economy B, average speed B [*] , and elapsed time B [*] .	With Refuel/IGN Off/Manually Reset^{*1}
		Fuel Efficiency Backlight	Turns the ambient meter feature on and off.	On^{*1}/Off
		Keyless Start Guidance Screens	Displays the push button start guidance when conditions are met to change power mode.	On^{*1}/Off

*1: Default Setting

* Not available on all models

Continued

Setup Group	Customizable Features	Description	Selectable Settings	
Vehicle Settings	Driving Position Setup*	Memory Position Link	Changes the driver's seat position to a stored setting.	On^{*1}/Off
	Keyless Access Setup	Door Unlock Mode	Changes which doors unlock when you grab the driver's door handle.	Drivers Door Only^{*1}/ All Doors
		Keyless Access Light Flash	Causes some exterior lights to blink when you unlock/lock the doors.	On^{*1}/Off
		Keyless Access Beep	Causes the beeper to sound when you unlock/lock the doors.	On^{*1}/Off
	Lighting Setup	Interior Light Dimming Time	Changes the length of time the interior lights stay on after you close the doors.	60seconds/ 30seconds^{*1}/ 15seconds
		Headlight Auto Off Timer	Changes the length of time the exterior lights stay on after you close the driver's door.	60seconds/ 30seconds/ 15seconds^{*1}/ 0seconds
		Auto Light Sensitivity	Changes the timing for the headlights to come on.	Max/High/Mid^{*1}/ Low/Min

*1:Default Setting

Setup Group	Customizable Features	Description	Selectable Settings
Vehicle Settings	Auto Door Lock	Changes the setting for when the doors automatically lock.	With Vehicle Speed*1/ Shift from P/Off
	Auto Door Unlock	Changes the setting for when the doors automatically unlock.	All Doors When Driver's Door Opens*1/ All Doors When Shifted to Park/All Doors When Ignition Switched Off/Off
	Key And Remote Unlock Mode	Sets up either the driver's door or all doors to unlock on the first push of the remote.	Driver Door*1/All Doors
	Keyless Lock Answer Back	LOCK/UNLOCK- The exterior lights flash. LOCK (2nd push)- The beeper sounds.	On*1/Off
	Security Relock Timer	Changes the time it takes for the doors to relock and the security system to set after you unlock the vehicle without opening any door.	90seconds/ 60seconds/ 30seconds*1
	Maintenance Info.	Maintenance Reset	Resets the engine oil life display when you have performed the maintenance service.
Default		Cancels/Resets all customized items in the Vehicle Settings group as default.	Default/OK

*1:Default Setting

Setup Group	Customizable Features	Description	Selectable Settings	
Camera Settings	Lane-Watch	Show with Turn Signal	Selects whether the LaneWatch display comes on when you move the turn signal lever to the passenger side.	On*1/Off
		Reference Lines	Selects whether the reference lines come on the LaneWatch monitor.	On*1/Off
		Next Maneuver Pop up	Selects whether a turn direction screen of the navigation system interrupts on the LaneWatch display.	On*1/Off
		Brightness	Adjusts the LaneWatch display settings.	—
		Contrast		
	Display	Black Level	Adjusts the LaneWatch display settings.	—
		Color		
		Tint		
		Default	Cancels/Resets all customized items in the LaneWatch group as default.	Default/OK
	Rear Camera	Fixed Guideline	Selects whether the fixed guidelines come on the rear camera monitor.	On*1/Off
Dynamic Guideline		Selects whether the dynamic guidelines come on the rear camera monitor.	On*1/Off	
Default		Cancels/Resets all customized items in the Rear Camera group as default.	Default/OK	

*1:Default Setting

Setup Group	Customizable Features	Description	Selectable Settings
Audio Settings	CD mode Recording from CD	Selects whether the songs on music CDs are automatically recorded to the HDD.	Auto/Manual *1
	CD mode Recording Quality	Selects the quality of the music files recorded to the HDD.	Standard *1/ High
	HDD mode HDD Info	Displays the HDD capacity.	—
	CD or HDD mode Update Gracenote Album Info	Updates the Gracenote® Album Info (Gracenote® Media Database).	Update by USB *1/ Update by CD
	HDD mode Delete All HDD Data	 Deleting All HDD Data P. 335	—
	Bluetooth® Audio, Pandora®* or Aha™ mode Bluetooth Device List	Edits or deletes a <i>Bluetooth</i> ® Audio device paired to HFL.	—
	Bluetooth Connect Bluetooth Audio Device	Connects, disconnects or pairs a <i>Bluetooth</i> ® Audio device to HFL.	—

*1:Default Setting

* Not available on all models

Setup Group	Customizable Features	Description	Selectable Settings
Audio Settings	Other	Source Select Popup Selects whether the list of selectable audio sources comes on when the AUDIO button is pressed.	On/Off* ¹
		CD (MP3/WMA/AAC), iPod, USB, Pandora®* or Aha™ mode Cover Art Turns on and off the cover art display.	On* ¹ /Off
	Default	Cancels/Resets all customized items in the Audio Settings group as default.	Default/OK
Phone Settings	Phone	Connect phone Pairs a new phone to HFL, connects or disconnects a paired phone. ➤ Phone Setup P. 381	—
		Bluetooth Device List Pairs a new phone to HFL, edits or deletes a paired phone, or creates a security PIN. ➤ Phone Setup P. 381	—
		Edit Speed Dial Edits, adds or deletes a speed dial entry. ➤ Phone Setup P. 381	—

*1:Default Setting

Setup Group	Customizable Features	Description	Selectable Settings
Phone Settings	Auto Transfer	Sets calls to automatically transfer from your phone to HFL when you enter the vehicle.	On*1/Off
	Auto Answer	Sets whether to automatically answer an incoming call after about four seconds.	On/Off*1
	Phone Ring Tone	Selects the ring tone.	Fixed/Mobile Phone*1/Off
	Automatic Phone Sync	Sets a phonebook data to be automatically imported when a phone is paired to HFL.	On*1/Off
	Use Contact Photo	Displays a caller's picture on an incoming call screen.	On*1/Off
	Enable Text/Email	Turns the text/e-mail message function on and off.	On*1/Off
	Text/Email Select Account	Selects a text/e-mail message account.	—
	New Text/Email Alert	Selects whether a pop-up alert comes on the screen when HFL receives a new text/e-mail message.	On/Off*1
	Default	Cancels/Resets all customized items in the Phone Settings group as default.	Yes/No

*1:Default Setting

Features

Setup Group	Customizable Features	Description	Selectable Settings	
Info Settings	Clock/ Wallpaper type	Clock Wallpaper		
		Clock Adjustment		
	Clock	Clock Format	See System Settings on P. 322 to P. 324.	
		Auto Time Zone*		
		Auto Daylight*		
		Clock Reset		
	Others	Info Screen Preference	<p>Selects any of the following to be displayed when you press the INFO button.</p> <ul style="list-style-type: none"> • Info Top: Some of the available menu items pop up. • Info Menu: All available menu items pop up. • Off: The menu item you selected last time is displayed. 	Info Top/Info Menu* ¹ /Off
Default		<p>Cancels/Resets all customized items in the Info Settings group as default.</p>	Default/OK	

*1: Default Setting

Models without navigation system

Defaulting All the Settings

Reset all the menu and customized settings as the factory defaults.

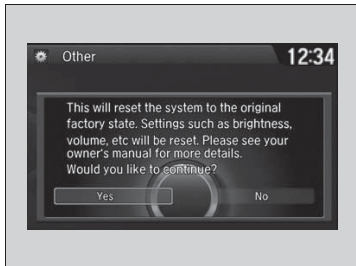

Models with one display

1. Press the **SETTINGS** button.

Models with two displays

1. Press and hold the **DISP** button.

All models

2. Rotate to select **System Settings**, then press .
 - Repeat the procedure to select **Other**, then **Factory Data Reset**.
 - The confirmation message will appear.
3. Rotate to select **Yes**, then press to reset the settings.
4. Rotate to select **Yes**, then press again to reset the settings.
 - The confirmation message will appear.
 - Press to select **OK**.

► Defaulting All the Settings

When you transfer the vehicle to a third party, reset all settings to default and delete all personal data.

The following settings will be reset:

- Audio preset settings
- Phonebook entries
- Other display and each item settings.

FarmaSOS.com

Models with navigation system

Defaulting All the Settings

Reset all the menu and customized settings as the factory defaults.

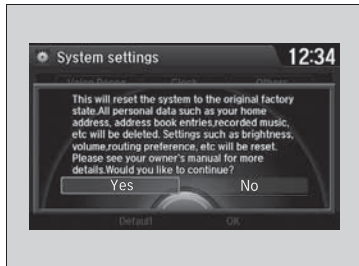

1. Press the **SETTINGS** button.
2. Rotate to select **System Settings**, then press .
3. Move or to select the **Others** tab.
4. Rotate to select **Factory Data Reset**, then press .
 - The pop-up menu appears on the screen.
5. Rotate to select **Yes**, then press .
 - The confirmation message will appear.
6. Rotate to select **Yes**, then press again to reset the settings.
 - The confirmation message will appear.

تلفن شبانه روزی: ۰۸۵-۲۸۸۶۲۰۱-۱

FarmaSOS.com

►► Defaulting All the Settings

When you transfer the vehicle to a third party, reset all settings to default and delete all personal data.

The following settings will be reset:

- Routing & Guidance: Rerouting, Unverified Area Routing, Traffic Rerouting, Edit Waypoint Search Area, Guidance Mode, Street Name Guidance
- Route Preference
- Audio preset settings
- Phonebook entries
- Other display and each item settings.

Models with navigation system

Deleting All HDD Data

Reset all the menu and customized settings, and delete all music data on the HDD.



1. Turn on the audio system and select the HDD mode.
2. Press the **SETTINGS** button.
3. Rotate to select **Audio Settings**, then press .
4. Move or to select the **CD/HDD** tab.
5. Rotate to select **Delete All HDD Data**, then press .
 - ▶ The confirmation message will appear.
6. Rotate to select **Yes**, then press .

تلفن شبانه روزی: ۰۲۱-۸۸۸۶۲۰۸۵

FarmaSOS.com

The HomeLink® Universal Transceiver can be programmed to operate up to three remote controlled devices around your home, such as garage doors, lighting, or home security systems.

Important Safety Precautions

Refer to the safety information that came with your garage door opener to test that the safety features are functioning properly. If you do not have the safety information, contact the manufacturer.

Before programming HomeLink, make sure that people and objects are out of the way of the garage or gate to prevent potential injury or damage.

When programming a garage door opener, park just outside the garage door's path.

Training HomeLink

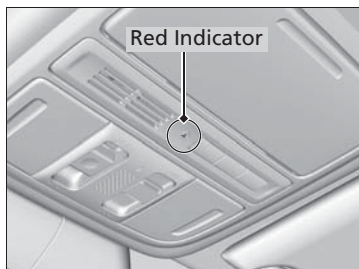

If you have not trained any of the buttons in HomeLink before, you should erase any previously learned codes. To do this:

- Press and hold the two outside buttons for about 20 seconds, until the red indicator blinks. Release the buttons, and proceed to step 1.
- If you are training the second or third button, go directly to step 1.

HomeLink® Universal Transceiver*

HomeLink® is a registered trademark of Johnson Controls., Inc.

Before programming HomeLink to operate a garage door opener, confirm that the opener has an external entrapment protection system, such as an "electronic eye," or other safety and reverse stop features. If it does not, HomeLink may not be able to operate it.

Training a Button

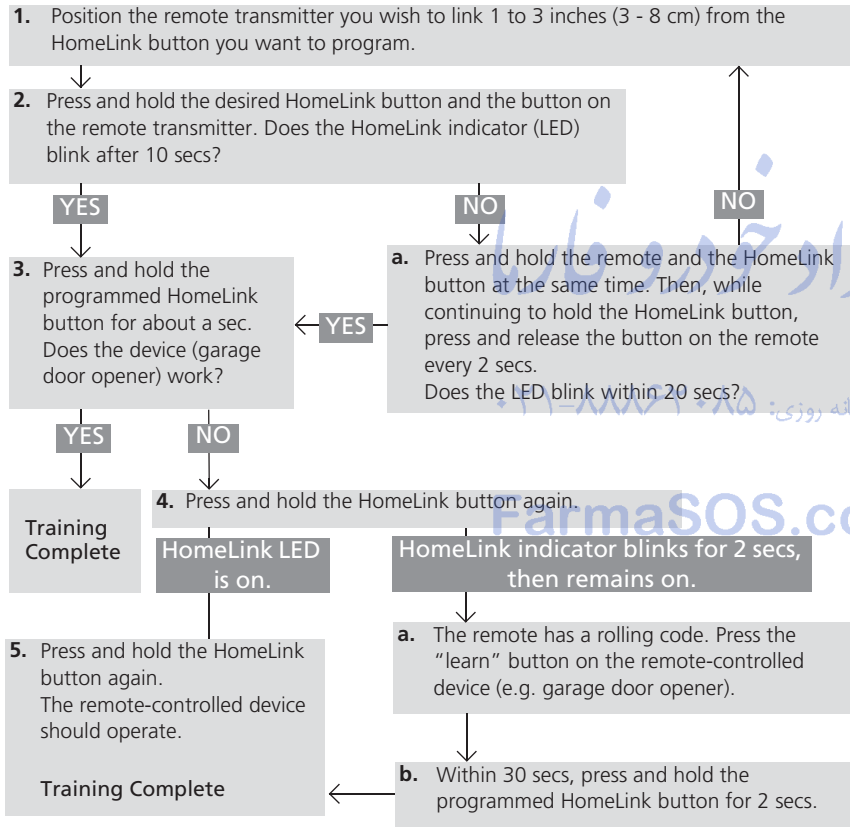

Training HomeLink

Retraining a Button
 If you want to retrain a programmed button for a new device, you do not have to erase all button memory. You can replace the existing memory code using this procedure:

- Press and hold the desired HomeLink button until the HomeLink indicator begins to blink.
 - Standard transmitter**
Indicator remains on for about 25 secs.
 - Rolling code transmitter**
Indicator blinks rapidly for 2 secs, then remains on for about 23 secs.
- Continue to hold the HomeLink button and follow steps 1 - 3 under "Training a Button."

Erasing Codes
 To erase all the codes, press and hold the two outside buttons until the HomeLink indicator begins to blink (about 10 to 20 secs). You should erase all codes before selling the vehicle.

If you have any problems, see the device's instructions, visit www.homelink.com, or call HomeLink at (800) 355-3515.

Features

Models without navigation system

Bluetooth® HandsFreeLink® (HFL) allows you to place and receive phone calls using your vehicle's audio system, without handling your cell phone.

Using HFL

HFL Buttons

Models with one display





 **(Pick-up) button:** Press to answer an incoming call.

 **(Hang-up/back) button:** Press to end a call or to cancel a command.

 **(Talk) button:** Press to call a number with a stored voice tag, a phonebook name, or a number.

PHONE button: Press to go directly to the Phone screen.

Selector knob: Rotate  to select an item on the screen, then press .

Bluetooth® HandsFreeLink®

To use HFL, you need a *Bluetooth*-compatible cell phone. For a list of compatible phones, pairing procedures, and special feature capabilities:

- U.S.: Visit www.handsfreelink.honda.com, or call 1-888-528-7876.
- Canada: Visit www.handsfreelink.ca, or call 1-888-528-7876.

To use HFL, the **Bluetooth On/Off** setting must be **On**.

Customized Features P. 298

Voice control tips

- Aim the vents away from the ceiling and close the windows, as noise coming from them may interfere with the microphone.
- Press and release the  button when you want to call a number using a stored voice tag, a phonebook name, or a number. Speak clearly and naturally after a beep.
- If the microphone picks up voices other than yours, the command may be misinterpreted.
- To change the volume level, use the audio system's volume knob or the remote audio controls on the steering wheel.

State or local laws may prohibit the operation of handheld electronic devices while operating a vehicle.

If you receive a call while using the audio system, the system resumes its operation after ending the call.

Models with two displays

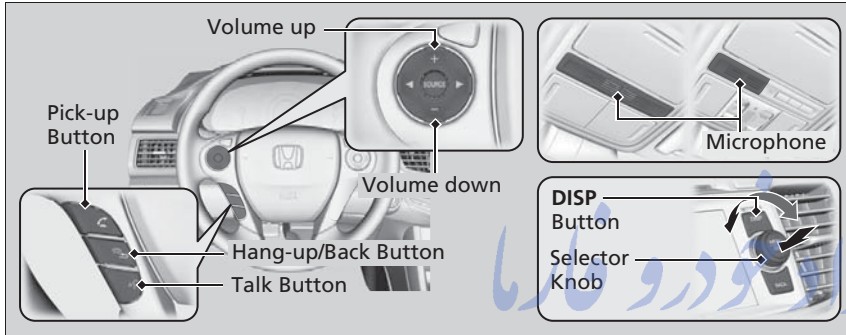

▶ Bluetooth® HandsFreeLink®

Bluetooth® Wireless Technology

The Bluetooth® word mark and logos are registered trademarks owned by Bluetooth SIG, Inc., and any use of such marks by Honda Motor Co., Ltd., is under license. Other trademarks and trade names are those of their respective owners.



HFL Limitations

An incoming call on HFL will interrupt the audio system when it is playing. It will resume when the call is ended.



 **(Pick-up) button:** Press to display the phone menu on half of the screen, or to answer an incoming call.

 **(Hang-up/back) button:** Press to end a call or to cancel a command.

 **(Talk) button:** Press to call a number with a stored voice tag, a phonebook name, or a number.

Selector knob: Rotate  to select an item on the screen, then press .

To go to the Phone screen:

1. Press the **DISP** button to switch the display to the **Function Change** screen.
2. Rotate  to select **Phone**, then press .

تلفن شبانه روزی: ۰۲۱-۸۸۶۲۰۸۵
FarmSOS.com

HFL Status Display

The audio/information screen notifies you when there is an incoming call.

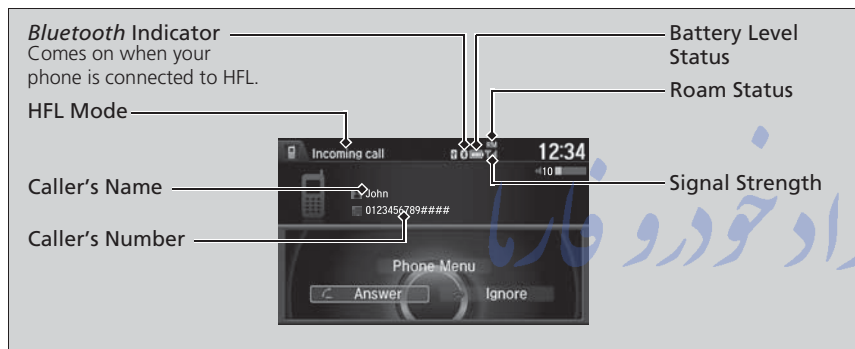

HFL Status Display

The information that appears on the audio/information screen varies between phone models.

You can change the system language to English, French, or Spanish.

▶ **Customized Features** P. 298

Limitations for Manual Operation



Certain manual functions are disabled or inoperable while the vehicle is in motion.

You cannot select a grayed-out option until the vehicle is stopped.

Only previously stored speed dial entries with voice tags, phonebook names, or numbers can be called using voice commands while the vehicle is in motion.

▶ **Speed Dial** P. 357

HFL Menus

The ignition switch must be in ACCESSORY **I** or ON **II***1 to use HFL.

■ Phone Settings screen



☒ HFL Menu

To use HFL, you must first pair your *Bluetooth*-compatible cell phone to the system while the vehicle is parked.

Some functions are limited while driving. A message appears on the screen when the vehicle is moving and the operation is canceled.

Models with one display

1. Press the **SETTINGS** button.

Models with two displays

1. Press and hold the **DISP** button.

All models

2. Rotate to select **Phone Settings**, then press .

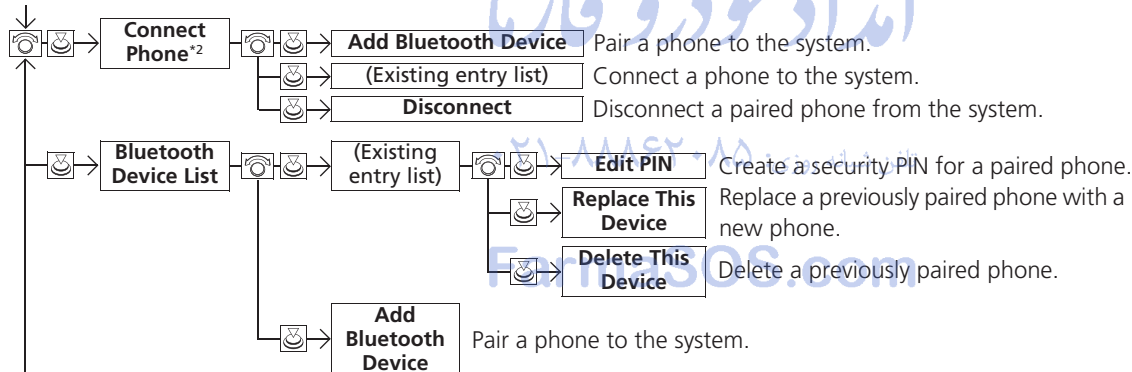

*1: Models with the smart entry system have an **ENGINE START/STOP** button instead of an ignition switch.

*2: Appears when a phone has already been paired to HFL.

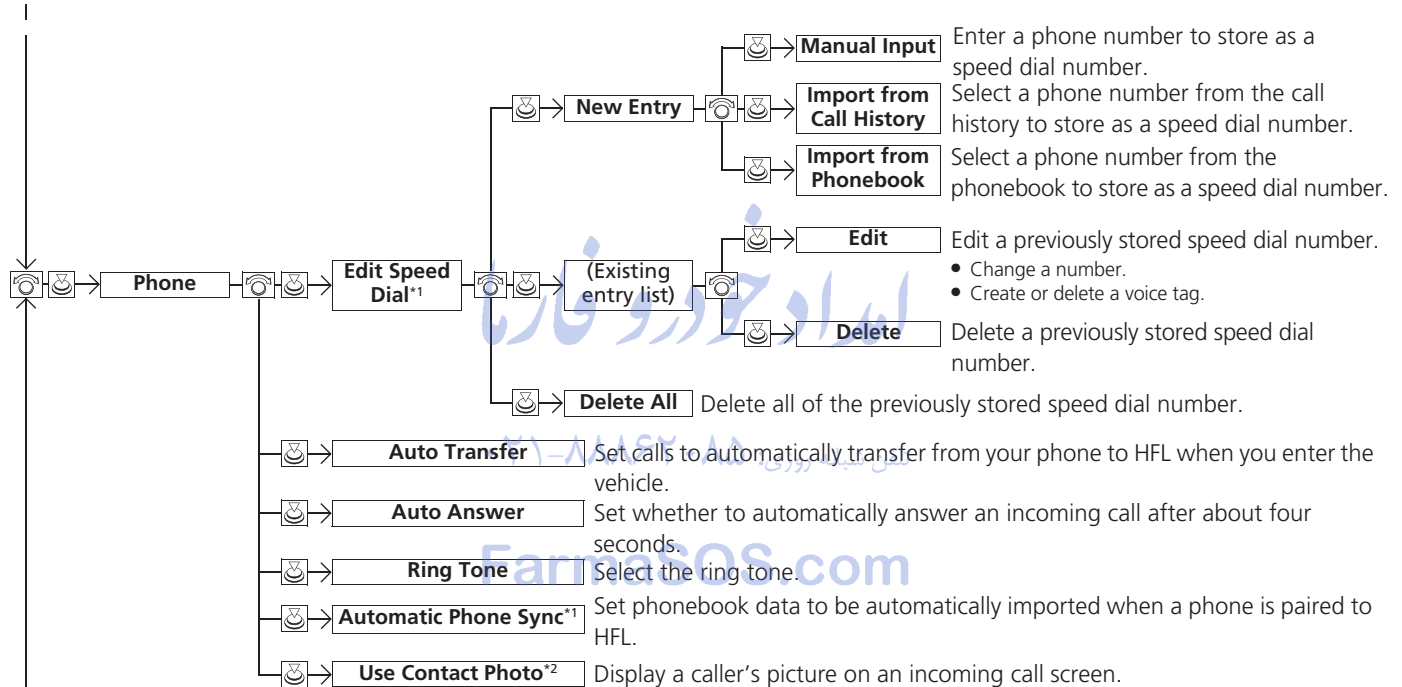

*1: Appears only when a phone is connected to HFL.

*2: Models with two displays

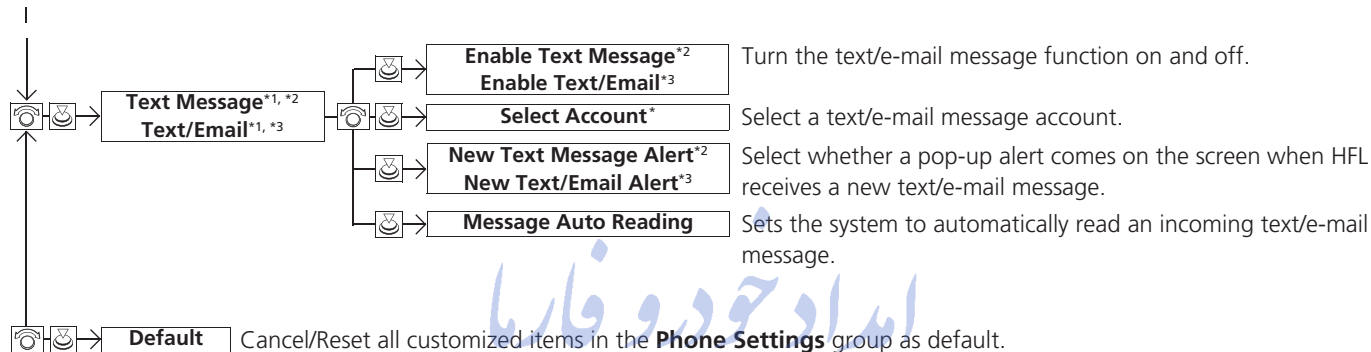

تلفن شبانه روزی: ۰۲۱-۸۸۸۶۲۰۸۵

FarmaSOS.com

* 1: Appears only when a phone is connected to HFL.

* 2: Models with one display

* 3: Models with two displays

* Not available on all models

■ Phone screen



Models with one display

1. Press the **PHONE** button.
2. Press the **MENU** button to display the menu items.

Models with two displays

1. Press the **DISP** button.
2. Rotate  to select **Phone**, then press .

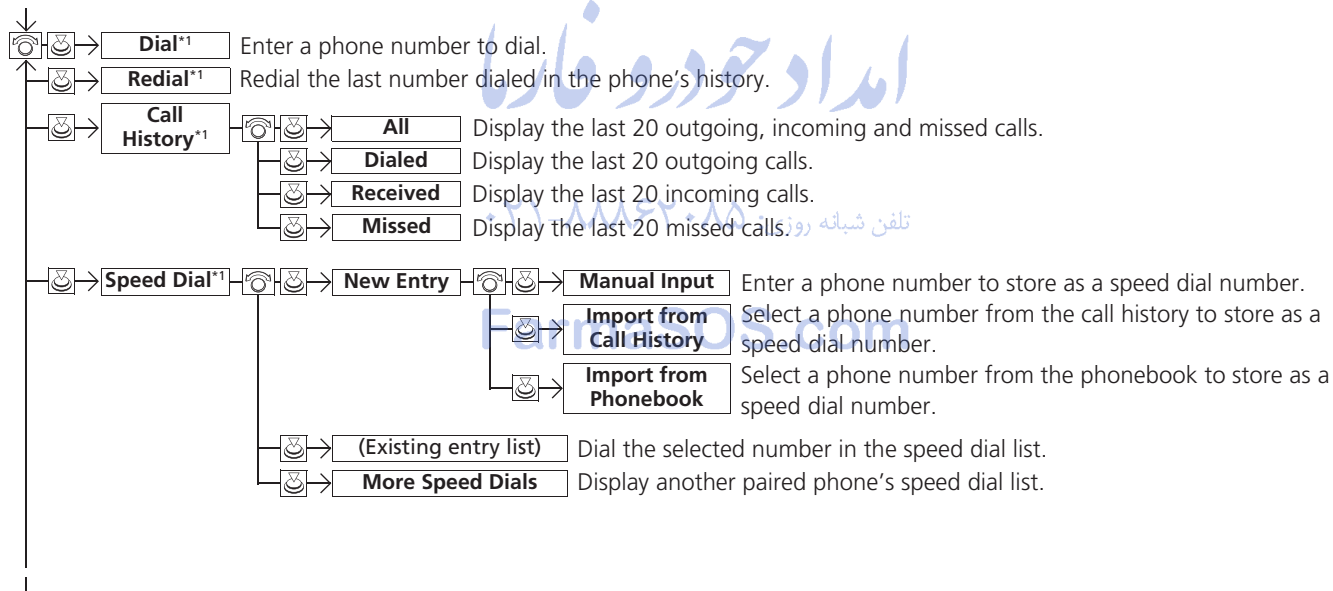

*1: Appears only when a phone is connected to HFL.

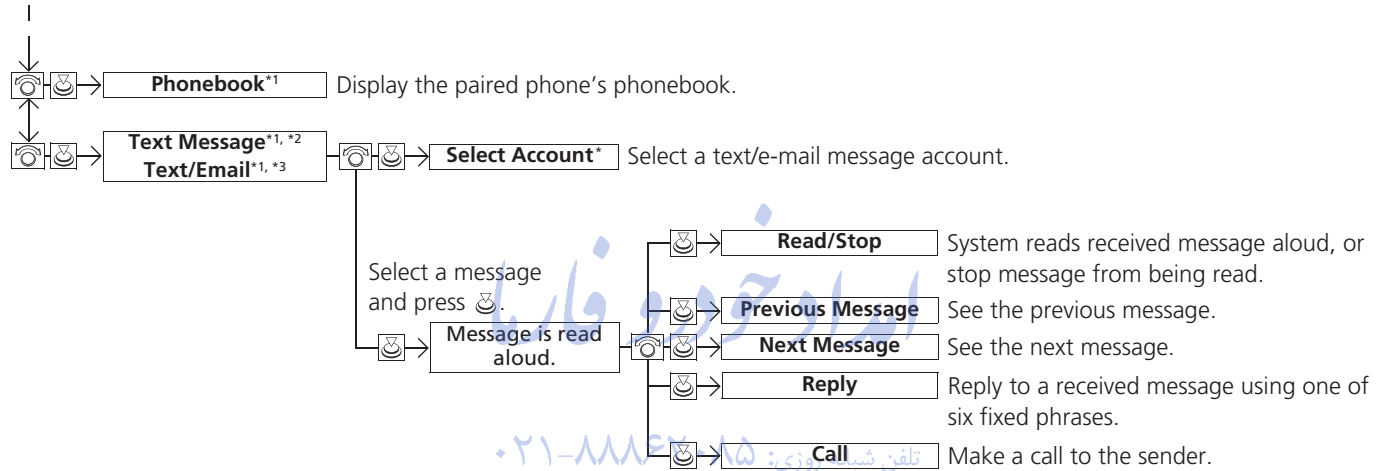

FarmaSOS.com

*1: Appears only when a phone is connected to HFL.

*2: Models with one display

*3: Models with two displays

* Not available on all models

Phone Setup

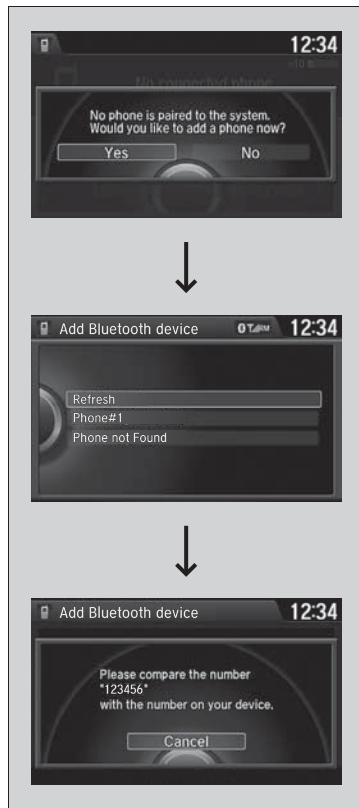

■ To pair a cell phone (when there is no phone paired to the system)

1. Go to the Phone screen.
 - ▶ **Phone screen** P. 344
2. Rotate to select **Yes**, then press .
3. Make sure your phone is search or discoverable mode, then press .
 - ▶ HFL automatically searches for a **Bluetooth** device.
4. When your phone appears on the list, select it by pressing .
 - ▶ If your phone does not appear, you can select **Refresh** to search again.
 - ▶ If your phone still does not appear, select **Phone Not Found** and search for **Bluetooth** devices using your phone. From your phone, select **HandsFreeLink**.
5. HFL gives you a pairing code on the audio/information screen.
 - ▶ Confirm if the pairing code on the screen and your phone match. This may vary by phone.
6. You will receive a notification on the screen if pairing is successful.

▶▶ Phone Setup

Your **Bluetooth**-compatible phone must be paired to HFL before you can make and receive hands-free calls.

Phone Pairing Tips:

- You cannot pair your phone while the vehicle is moving.
- Up to six phones can be paired.
- Your phone's battery may drain faster when it is paired to HFL.
- If your phone is not ready for pairing or not found by the system within three minutes, the system will time out and returns to idle.

Once you have paired a phone, you can see it displayed on the screen with one or two icons on the right side.

These icons indicate the following:

- : The phone can be used with HFL.
- : The phone is compatible with **Bluetooth**® Audio.

When pairing is completed, an **Automatic Phone Sync** prompt appears. Select **On** if you want your call history and phonebook automatically imported to HFL.

- ▶ **Changing the Automatic Phone Sync setting** P. 356

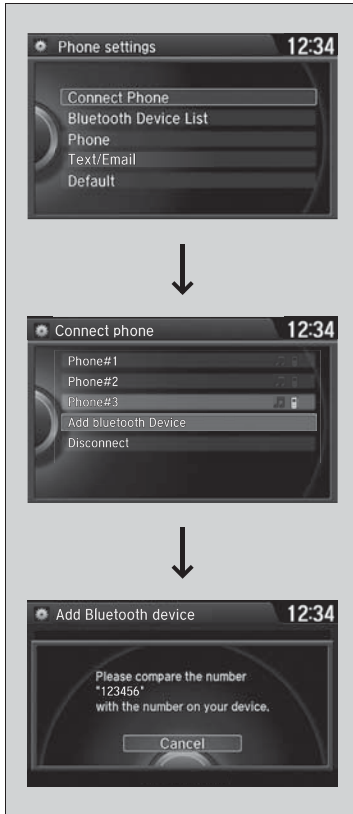

■ **To pair a cell phone (when a phone has already been paired to the system)**

1. Go to the **Phone Settings** screen.
 - ▶ **Phone Settings screen** P. 341
2. Rotate to select **Connect Phone**, then press .
- ▶ Repeat the procedure to select **Add Bluetooth Device**.
3. Make sure your phone is in search or discoverable mode, then press .
 - ▶ HFL automatically searches for a *Bluetooth* device.
4. When your phone appears on the list, select it by pressing .
 - ▶ If your phone does not appear, you can select **Refresh** to search again. *تلفن شبانه روزی*
 - ▶ If your phone still does not appear, select **Phone Not Found** and search for *Bluetooth* devices using your phone. *فایلی.303.com*
From your phone, select **HandsFreeLink**.
5. HFL gives you a pairing code on the audio/information screen.
 - ▶ Confirm if the pairing code on the screen and your phone match.
This may vary by phone.
6. You will receive a notification on the screen if pairing is successful.

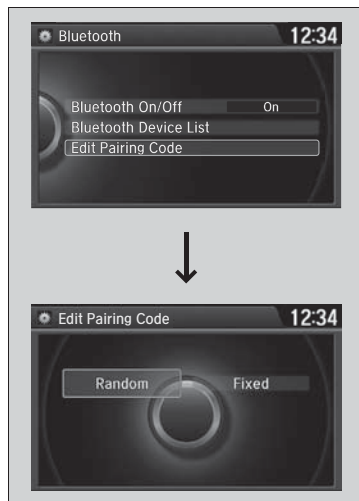

■ To change the pairing code setting

Models with one display

1. Press the **SETTINGS** button.

Models with two displays

1. Press and hold the **DISP** button.

All models

2. Rotate to select **System Settings**, then press .
- ▶ Repeat the procedure to select **Bluetooth**, then **Edit Pairing Code**.
3. Rotate to select **Fixed** or **Random**, then press .

▶▶ To change the pairing code setting

The pairing code may be six or four digits depending on your phone.

The default pairing code is **0000** until you change the setting.

To create your own, select **Fixed**, and delete the current code, then enter a new one.

For a randomly generated pairing code each time you pair a phone, select **Random**.

تلفن شبانه روزی: ۰۲۱-۸۸۸۶۲۰۸۵

FarmaSOS.com



■ **To replace an already-paired phone with a new phone**

1. Go to the **Phone Settings** screen.

▶ **Phone Settings screen** P. 341

2. Rotate to select **Bluetooth Device List**, then press .

3. Rotate to select a paired phone you want to replace, then press .

4. Rotate to select **Replace This Device**, then press .

5. HFL enters the pairing process and searches a new phone.

▶ Follow the prompts to pair a new phone.

6. You will receive a notification on the screen if pairing is successful.

▶▶ To replace an already-paired phone with a new phone









The replaced phone will keep the same speed dial entries, call history, and security PIN information from the previously paired phone.

امداد خودروفا
تلفن شبانه روزی: ۰۸۵-۸۸۶۲۰۸۵-۲۲

FarmaSOS.com



■ To delete a paired phone

1. Go to the **Phone Settings** screen.
 ▶ **Phone Settings screen** P. 341
2. Rotate  to select **Bluetooth Device List**, then press .
3. Rotate  to select a phone you want to delete, then press .
4. Rotate  to select **Delete This Device**, then press .
5. You will receive a confirmation message on the screen. Rotate  to select **Yes**, then press .
6. You will receive a notification on the screen if it is successful.

تلفن شبانه روزی: ۰۲۱-۸۸۸۶۲۰۸۵

FarmaSOS.com

To Set Up a Text/E-Mail Message Options

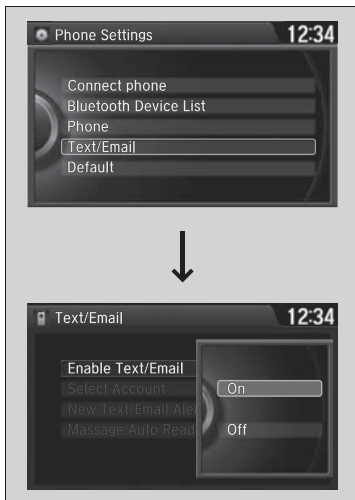

■ To turn on or off the text/e-mail message function

1. Go to the **Phone Settings** screen.
 ▶ **Phone Settings** screen P. 341

Models with one display

2. Rotate to select **Text Message**, then press .
 - ▶ Repeat the procedure to select **Enable Text Message**.
 - ▶ A pop-up menu appears on the screen.

Models with two displays

2. Rotate to select **Text/Email**, then press .
 - ▶ Repeat the procedure to select **Enable Text/Email**.
 - ▶ A pop-up menu appears on the screen.

All models

3. Rotate to select **On** or **Off**, then press .

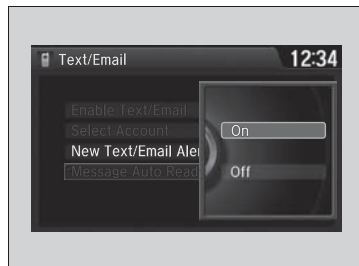

■ To turn on or off the text/e-mail message notice

Models with one display

1. On the **Text Message** screen, rotate to select **New Text Message Alert**, then press .

Models with two displays

1. On the **Text/Email** screen, rotate to select **New Text/Email Alert**, then press .
▶ A pop-up menu appears on the screen.

All models

2. Rotate to select **On** or **Off**, then press .

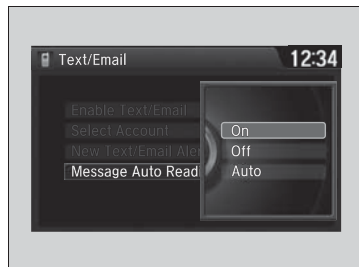

■ To set up the auto reading option

1. On the **Text Message** or the **Text/Email** screen, rotate to select **Message Auto Reading**, then press .
▶ A pop-up menu appears on the screen.
2. Rotate to select **On**, **Off** or **Auto** then press .

▶▶ To turn on or off the text/e-mail message notice

- On:** A pop-up notification comes on every time you receive a new message.
- Off:** The message you receive is stored in the system without notification.

▶▶ To set up the auto reading option

- On:** A text/e-mail message is always read aloud.
- Off:** A text/e-mail message is not read aloud.
- Auto:** A text/e-mail message is read aloud only when driving.

To Create a Security PIN

You can protect each of the six cell phones with a security PIN.

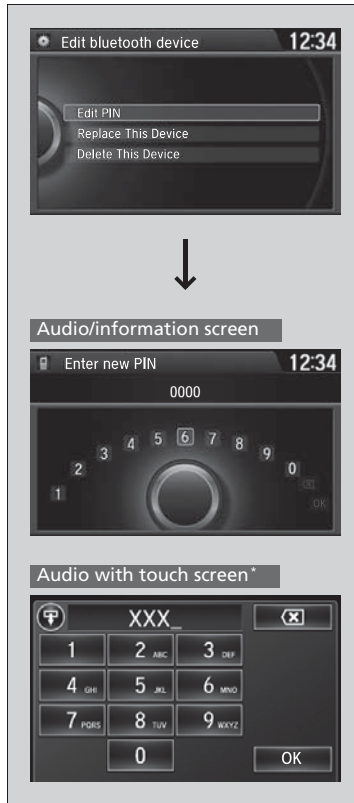

To Create a Security PIN

If the phone is already security PIN protected, you need to enter the current security PIN before clearing the PIN or creating a new one.

1. Go to the **Phone Settings** screen.
 - ▶ **Phone Settings screen** P. 341
2. Rotate to select **Bluetooth Device List**, then press .
3. Rotate to select a phone you want to add a security PIN to, then press .
4. Rotate to select **Edit PIN**, then press .
5. Enter a new four-digit number.
 - ▶ **Audio/information screen**
Rotate to select, then press .
Press to delete. Press **OK** to enter the security PIN.
 - ▶ **Audio with touch screen***
You can also enter a number using the icons.
6. Re-enter the four-digit number.
 - ▶ The screen returns to the screen in step 4.

* Not available on all models

Continued

Automatic Transferring

If you get into the vehicle while you are on the phone, the call can be automatically transferred to HFL.

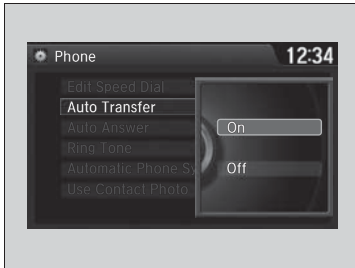

1. Go to the **Phone Settings** screen.
 ► **Phone Settings screen** P. 341
2. Rotate to select **Phone**, then press .
- Repeat the procedure to select **Auto Transfer**.
3. Rotate to select **On**, then press .

Auto Answer

You can set HFL to automatically answer an incoming call in four seconds.

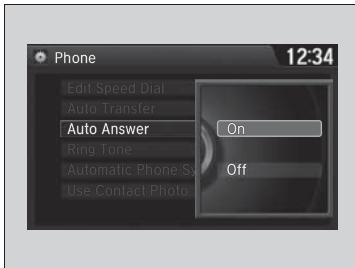

1. Go to the **Phone Settings** screen.
 ► **Phone Settings screen** P. 341
2. Rotate to select **Phone**, then press .
- Repeat the procedure to select **Auto Answer**.
3. Rotate to select **On**, then press .

امداد خودرو فارما

تلفن شبانه روزی: ۰۲۱-۸۸۸۶۲۰۸۵

FarmaSOS.com

Ring Tone

You can change the ring tone setting.

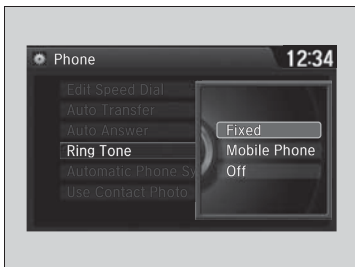

1. Go to the **Phone Settings** screen.
 ▶ **Phone Settings screen** P. 341
2. Rotate to select **Phone**, then press .
 ▶ Repeat the procedure to select **Ring Tone**.
3. Rotate to select **Fixed**, **Mobile Phone** or **Off**, then press .

Ring Tone

Fixed: The fixed ring tone sounds from the speaker.

Mobile Phone: The ring tone stored in the connected cell phone sounds from the speaker.

Off: No ring tones sound from the speaker.

Models with two displays

Use Contact Photo

You can display a caller's picture on an incoming call screen.



1. Go to the **Phone Settings** screen.
 ▶ **Phone Settings screen** P. 341
2. Rotate to select **Phone**, then press .
 ▶ Repeat the procedure to select **Use Contact Photo**.
3. Rotate to select **On** or **Off**, then press .

امداد خودرو فارما

تلفن شبانه روزی: ۰۲۱-۸۸۸۶۲۰۸۵

www.888.com

Automatic Import of Cellular Phonebook and Call History

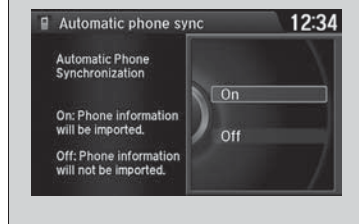
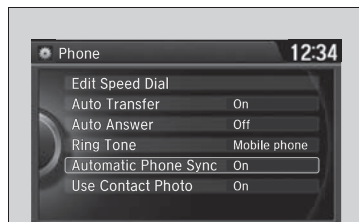
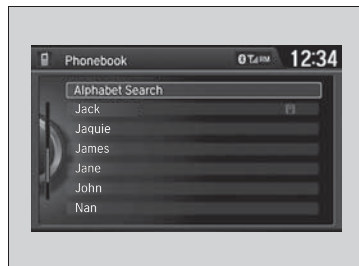

When Automatic Phone Sync is set to On:

When your phone is paired, the contents of its phonebook and call history are automatically imported to HFL.

Changing the Automatic Phone Sync setting

1. Go to the **Phone Settings** screen.

▶ **Phone Settings screen** P. 341

2. Rotate to select **Phone**, then press . Repeat the procedure to select **Automatic Phone Sync**.

3. Rotate to select **On** or **Off**, then press .

Automatic Import of Cellular Phonebook and Call History

When you select a person from the list in the cellular phonebook, you can see up to three category icons. The icons indicate what types of numbers are stored for that name.

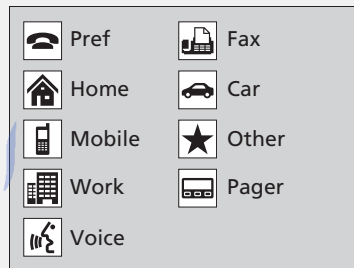

On some phones, it may not be possible to import the category icons to HFL.

The phonebook is updated after every connection. Call history is updated after every connection or call.

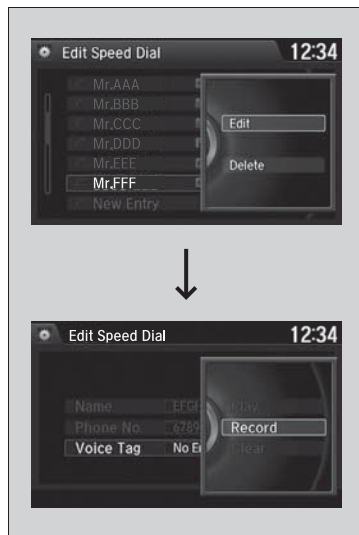

■ **To add a voice tag to a stored speed dial number**

1. Go to the **Phone Settings** screen.
 - ▶ **Phone Settings screen** P. 341
2. Rotate to select **Phone**, then press .
- ▶ Repeat the procedure to select **Edit Speed Dial**.
3. Select an existing speed dial entry.
 - ▶ From the pop-up menu, rotate to select **Edit**, then press .
4. Rotate to select **Voice Tag**, then press .
 - ▶ From the pop-up menu, rotate to select **Record**, then press .
5. Using the button, follow the prompts to complete the voice tag.

▶▶ Speed Dial

Avoid using duplicate voice tags. Avoid using "home" as a voice tag. It is easier for HFL to recognize a longer name. For example, use "John Smith" instead of "John."

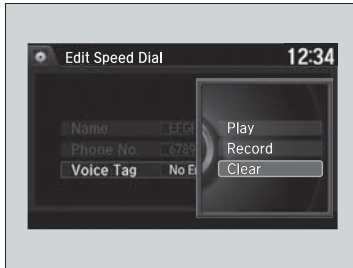

■ **To delete a voice tag**

1. Go to the **Phone Settings** screen.
 ▶ **Phone Settings screen** P. 341
2. Rotate to select **Phone**, then press .
 ▶ Repeat the procedure to select **Edit Speed Dial**.
3. Select an existing speed dial entry.
 ▶ From the pop-up menu, rotate to select **Edit**, then press .
4. Rotate to select **Voice Tag**, then press .
 ▶ From the pop-up menu, rotate to select **Clear**, then press .
5. You will receive a confirmation message on the screen. Rotate to select **Yes**, then press .

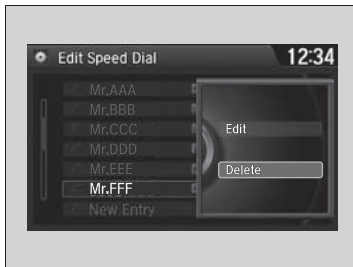

■ **To delete a speed dial**

1. Go to the **Phone Settings** screen.
 ▶ **Phone Settings screen** P. 341
2. Rotate to select **Phone**, then press .
 ▶ Repeat the procedure to select **Edit Speed Dial**.
3. Select an existing speed dial entry.
 ▶ From the pop-up menu, rotate to select **Delete**, then press .
4. You will receive a confirmation message on the screen. Rotate to select **Yes**, then press .

Continued

■ Making a Call



You can make calls by inputting any phone number, or by using the imported phonebook, call history, speed dial entries, or redial.

▶▶ Making a Call

Any voice-tagged speed dial entry, phonebook name, or number can be dialed by voice from most screens. Press the  button and say "Call" and the phonebook name, phone number, or stored voice tag.

The maximum range between your phone and vehicles is 30 feet (10 meters).

Once a call is connected, you can hear the voice of the person you are calling through the audio speakers.

امداد خودرو فارما

تلفن شبانه روزی: ۰۲۱-۸۸۸۶۲۰۸۵

FarmaSOS.com

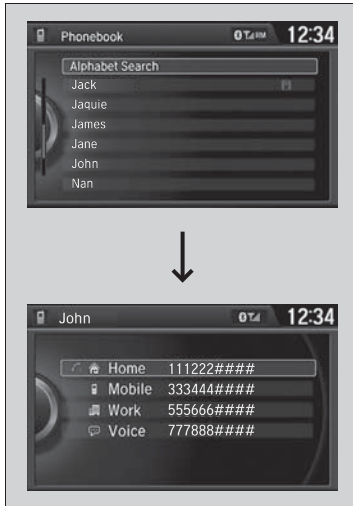

■ **To make a call using the imported phonebook**

1. Go to the Phone screen.
 ▶ **Phone screen** P. 344

Models with one display

Press the **MENU** button to display the menu items.

2. Rotate to select **Phonebook**, then press .
3. Rotate to select a name, then press .
 - ▶ You can also search by letter. Rotate to select **Alphabet Search**, then press .

Models with two displays

▶ Use the keyboard on the touch screen for entering letters.

4. Rotate to select a number, then press .
 - ▶ Dialing starts automatically.

▶ To make a call using the imported phonebook

This function is disabled while the vehicle is moving. However, you can call a stored voice-tagged speed dial number, phonebook name, or number using voice commands.

- ▶ **Limitations for Manual Operation** P. 340
- ▶ **Speed Dial** P. 357

Models with two displays

You can use the keyboard on the audio with touch screen for an alphabetical search.

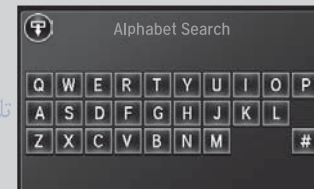



■ To make a call using a phone number

1. Go to the Phone screen.

➤ **Phone screen** P. 344

Models with one display

Press the **MENU** button to display the menu items.

2. Rotate to select **Dial**, then press .
3. Rotate to select a number, then press .
4. Rotate to select , then press .
 - ▶ Dialing starts automatically.

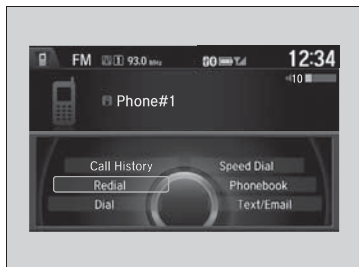

■ To make a call using redial

1. Go to the Phone screen.

➤ **Phone screen** P. 344

Models with one display

Press the **MENU** button to display the menu items.

2. Rotate to select **Redial**, then press .
 - ▶ Dialing starts automatically.

▶▶ To make a call using a phone number

This function is disabled while the vehicle is moving. However, you can call a stored voice-tagged speed dial number, phonebook name, or number using voice commands.

➤ **Limitations for Manual Operation** P. 340

➤ **Speed Dial** P. 357

Models with two displays

You can use the keyboard on the audio with touch screen to input numbers. Select numbers, then to start dialing.



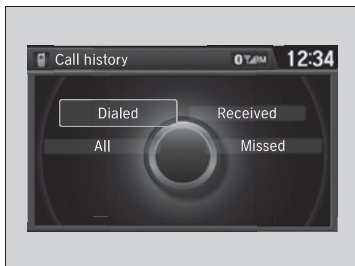

■ To make a call using the call history

Audio/information screen







Call history is stored by **All**, **Dialed**, **Received**, and **Missed**.

1. Go to the Phone screen.

➤ **Phone screen** P. 344

Models with one display

Press the **MENU** button to display the menu items.

2. Rotate  to select **Call History**, then press .
3. Rotate  to select **All**, **Dialed**, **Received**, or **Missed**, then press .
4. Rotate  to select a number, then press .

▶ Dialing starts automatically. تلفن شبانه روزی: ۰۲۱-۸۸۶۲۰۸۵

FarmaSOS.com

☒ To make a call using the call history

The call history displays the last 20 dialed, received, or missed calls.

(Appears only when a phone is connected to HFL.)



Audio with touch screen*

You can dial the last six numbers in the call history.

1. Select **Phone**.
2. Select **Call History**.
3. Select **1-6**.
 - ▶ Dialing starts automatically.

امداد خودرو فارما

تلفن شبانه روزی: ۰۲۱-۸۸۸۶۲۰۸۵

FarmaSOS.com

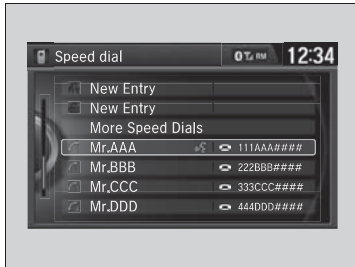

■ **To make a call using a speed dial entry**

Audio/information screen

1. Go to the Phone screen.
▶ **Phone screen** P. 344

Models with one display

Press the **MENU** button to display the menu items.

2. Rotate to select **Speed Dial**, then press .
3. Rotate to select a number, then press .
▶ Dialing starts automatically.

Audio with touch screen*

You can dial the first six numbers in the speed dial entries ().

1. Select **Phone**.
2. Select **Speed Dial**.
3. Select **1-6**.
▶ Dialing starts automatically.

▶▶ To make a call using a speed dial entry

Select **More Speed Dials** to view another paired phone's speed dial list. You can make a call from that list using the currently connected phone.

When a voice tag is stored, press the button to call the number using the voice tag.

▶ **Speed Dial** P. 357

Any voice-tagged speed dial entry, phonebook name, or number can be dialed by voice from any screen. Press the button and follow the prompts.

Models with one display

To call stored speed dial entries 1-6, press the corresponding preset buttons from the **Phone** screen.

* Not available on all models

Continued

Receiving a Call

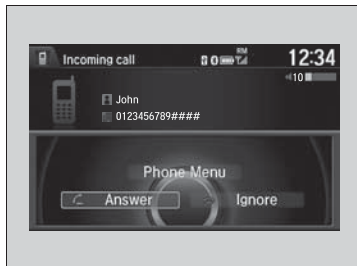

When there is an incoming call, an audible notification sounds (if activated) and the **Incoming Call** screen appears.

Press the  button to answer the call.

Press the  button to decline or end the call.

Receiving a Call

Call Waiting



Press the  button to put the current call on hold to answer the incoming call.

Press the  button again to return to the current call.

Ignore the incoming call if you do not want to answer it.

Press the  button if you want to hang up the current call.

Models with two displays

You can select the icons on the audio with touch screen instead of the  and  buttons.

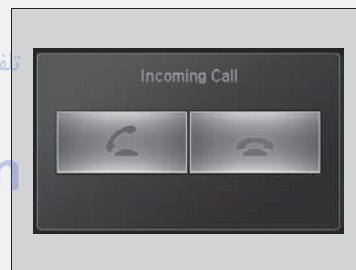

Options During a Call

The following options are available during a call.

Mute: Mute your voice.

Transfer: Transfer a call from HFL to your phone.

Touch Tones: Send numbers during a call. This is useful when you call a menu-driven phone system.

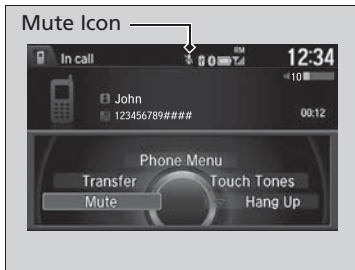

Models with one display

Press the **MENU** button to display the options.

Models with two displays

The available options are shown on the lower half of the screen.

All models

Rotate to select the mute option, then press .

- ▶ The mute icon appears when **Mute** is selected. Select **Mute** again to turn it off.

FarmaSOS.com

Options During a Call

Touch Tones: Available on some phones.

Models with two displays

You can select the icons on the audio with touch screen.



Receiving a Text/E-Mail Message

HFL can display newly received text messages as well as 20 of the most recently received messages on a linked cell phone. Each received message can be read aloud and replied to using a fixed common phrase.

Models with two displays

HFL can also display e-mail messages.

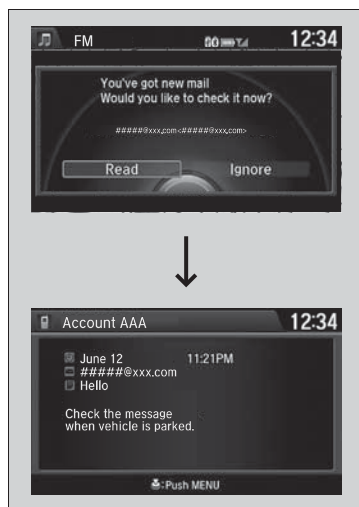

1. A pop-up appears and notifies you of a new text/e-mail message.
2. Rotate to select **Read** to listen to the message, then press .
 - ▶ The text/e-mail message is displayed. The system automatically starts reading out the message.
3. To discontinue the message read-out, press .

Receiving a Text/E-Mail Message

The system does not display any received messages while you are driving. You can only hear them read aloud.

With some phones, you may be able to display up to 20 most recent text/e-mail messages.

State or local laws may limit your use of the HFL text/e-mail message feature. Only use the text/e-mail message feature when conditions allow you to do so safely.

When you receive a text/e-mail message for the first time after the phone is paired to HFL, you are asked to turn the **New Text Message Alert** or the **New Text/Email Alert** setting to **On**.

To turn on or off the text/e-mail message notice P. 352



Models with two displays

Selecting a Mail Account

If a paired phone has text message or mail accounts, you can select one of them to be active and receive notifications.

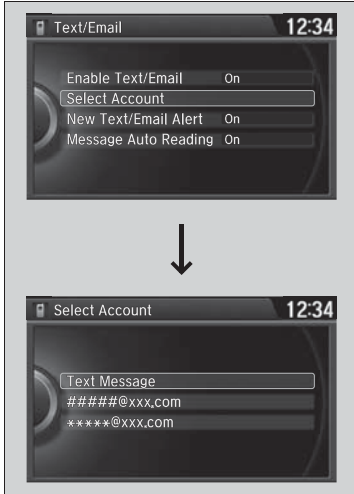

1. Go to the **Phone Settings** screen.
 ▶ **Phone Settings** screen P. 341
2. Rotate to select **Text/Email**, then press .
- ▶ Repeat the procedure to select **Select Account**.
3. Rotate to select **Text message** or an e-mail account you want, then press .

تلفن شبانه روزی: ۰۲۱-۸۸۸۶۲۰۸۵

FarmaSOS.com

Selecting a Mail Account

You can also select a mail account from the folder list screen or the message list screen.
 Rotate to select **Select Account** on the top of the list, then press .

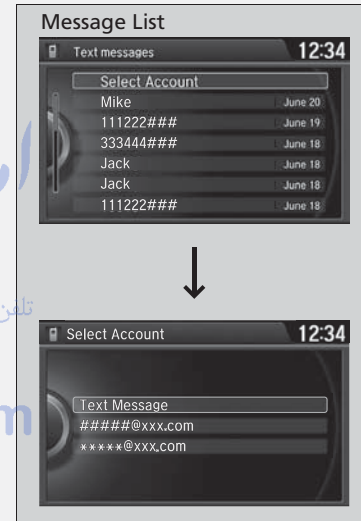

You can only receive notifications from one text message or mail account at a time.

Features

Displaying Messages

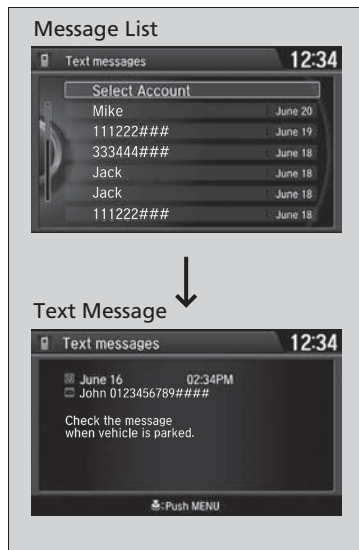

■ Displaying text messages

1. Go to the Phone screen.
 - ▶ **Phone screen** P. 344

Models with one display

Press the **MENU** button to display the menu items.

Models with one display

2. Rotate to select **Text Message**, then press .

Models with two displays

2. Rotate to select **Text/Email**, then press .
 - ▶ Select account if necessary.

All models

3. Rotate to select a message, then press .
 - ▶ The text message is displayed. The system automatically starts reading the message aloud.

▶▶ Displaying Messages

The icon appears next to an unread message.

If you delete a message on the phone, the message is also deleted in the system. If you send a message from the system, the message goes to your phone's mailbox.

To see the previous or next message, press on the text message screen. From the pop-up menu, rotate to select **Previous Message** or **Next Message**, then press .

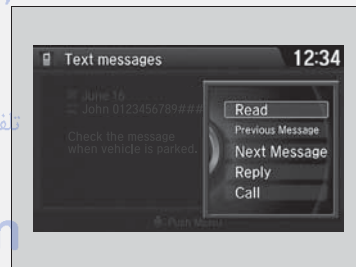



■ Displaying e-mail messages

Models with two displays

1. Go to the Phone screen.
 ▶ **Phone screen** P. 344
2. Rotate to select **Text/Email**, then press .
 ▶ Select account if necessary.
3. Rotate to select a folder, then press .
4. Rotate to select a message, then press .
 ▶ The e-mail is displayed. The system automatically starts reading the message aloud.

تلفن شبانه روزی: ۰۲۱-۸۸۸۶۲۰۸۵

FarmaSOS.com

▶▶ Displaying e-mail messages

Received text/e-mail messages may appear in the message list screen at the same time. In this case, text messages are titled **No Subject**.

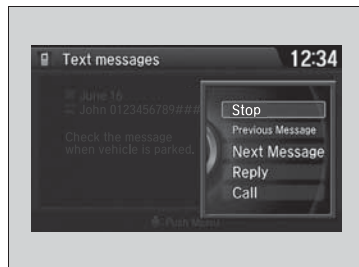

■ Using the Stop or Read option

1. Go to the text/e-mail message screen.
 - ▶ The system automatically starts reading the message aloud.
2. Press to have the pop-up menu appear on the screen.
3. Rotate to select **Stop** or **Read**, then press .

▶ **Displaying Messages** P. 370

▶▶ Using the Stop or Read option

This option changes to:

- **Stop** while the text/e-mail message is read out. Select this option to discontinue the message read out.
- **Read** when the system has finished reading out the text/e-mail message, or after you selected **Stop**. Select this option to hear the system read out the selected message.

امداد خودرو فارما

تلفن شبانه روزی: ۰۲۱-۸۸۸۶۲۰۸۵

FarmaSOS.com



■ Reply to a message

1. Go to the text/e-mail message screen.
 - ▶ The system automatically starts reading the message aloud.
 - ▶ **Displaying Messages** P. 370
2. Press to have the pop-up menu appear on the screen.
3. Rotate to select **Reply**, then press .
4. Rotate to select the reply message, then press .
 - ▶ The pop-up menu appears on the screen.
5. Select **Send** to send the message.
 - ▶ **Complete** appears on the screen when the reply message was successfully sent.

تلفن شبانه روزی: ۰۲۱-۸۸۸۶۲۰۸۵

FarmaSOS.com

▶ Reply to a message

The available fixed reply messages are as follows:

- **Talk to you later, I'm driving.**
- **I'm on my way.**
- **I'm running late.**
- **OK**
- **Yes**
- **No**

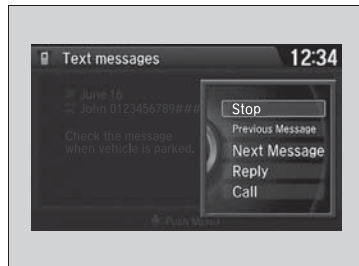

You cannot add, edit, or delete reply messages.



■ Making a call to a sender

1. Go to the text message screen.
 - The system automatically starts reading the message aloud.

☞ **Displaying text messages** P. 370

2. Press  to have the pop-up menu appear on the screen.
3. Rotate  to select **Call**, then press .

امداد خودرو فارما

تلفن شبانه روزی: ۰۲۱-۸۸۸۶۲۰۸۵

FarmaSOS.com

Models with navigation system

Bluetooth® HandsFreeLink® (HFL) allows you to place and receive phone calls using your vehicle's navigation system, without handling your cell phone.

Using HFL

HFL Buttons

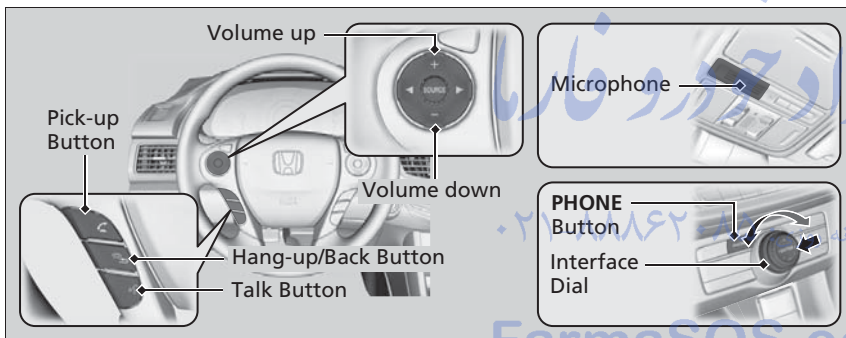

(Pick-up) button: Press to go to the **Phone Call** screen or to answer an incoming call.

(Hang-up/back) button: Press to end a call or to cancel a command.

(Talk) button: Press to give HFL voice commands.

PHONE button: Press to go directly to the Phone screen.

Interface dial: Rotate to select an item on the screen, then press . Move , , or to select secondary menu.

Bluetooth® HandsFreeLink®

To use HFL, you need a *Bluetooth*-compatible cell phone. For a list of compatible phones, pairing procedures, and special feature capabilities:

- U.S.: Visit www.handsfreelink.honda.com, or call 1-888-528-7876.
- Canada: Visit www.handsfreelink.ca, or call 1-888-528-7876.

To use HFL, the **Bluetooth Status** setting must be **On**.

Customized Features P. 298

Voice control tips

- Aim the vents away from the ceiling and close the windows, as noise coming from them may interfere with the microphone.
- Press and release the button when you want to call a number using a stored voice tag, a phonebook name, or a number. Speak clearly and naturally after a beep.
- If the microphone picks up voices other than yours, the command may be misinterpreted.
- To change the volume level, use the audio system's volume knob or the remote audio controls on the steering wheel.

State or local laws may prohibit the operation of handheld electronic devices while operating a vehicle.

If you receive a call while using the audio system, the system resumes its operation after ending the call.

Continued

HFL Status Display

The audio/information screen notifies you when there is an incoming call.

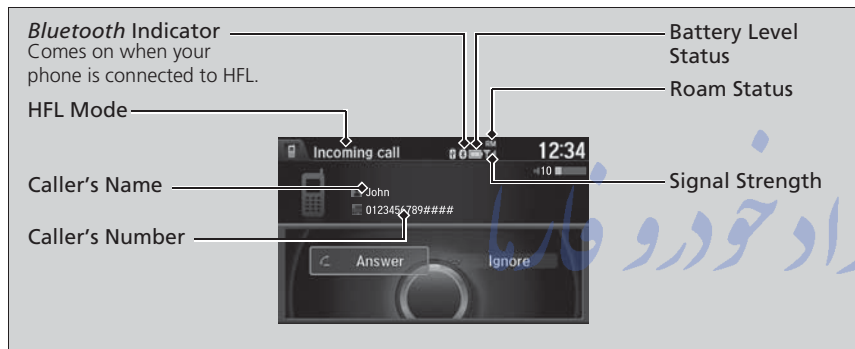

Limitations for Manual Operation

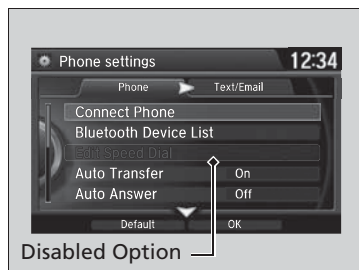

Certain manual functions are disabled or inoperable while the vehicle is in motion. You cannot select a grayed-out option until the vehicle is stopped.

Only previously stored speed dial entries with voice tags, phonebook names, or numbers can be called using voice commands while the vehicle is in motion.

▶ **Speed Dial** P. 393

Bluetooth® HandsFreeLink®

Bluetooth® Wireless Technology

The *Bluetooth*® word mark and logos are registered trademarks owned by Bluetooth SIG, Inc., and any use of such marks by Honda Motor Co., Ltd., is under license. Other trademarks and trade names are those of their respective owners.

HFL Limitations

An incoming call on HFL will interrupt the audio system when it is playing. It will resume when the call is ended.

HFL Status Display

The information that appears on the audio/information screen varies between phone models.

You can change the system language to English, French, or Spanish.

▶ **Customized Features** P. 298

HFL Menus

The power mode must be in ACCESSORY or ON to use HFL.

Phone Settings screen



1. Press the **SETTINGS** button.
2. Rotate to select **Phone Settings**, then press .

HFL Menu

To use HFL, you must first pair your *Bluetooth*-compatible cell phone to the system while the vehicle is parked.

Some functions are limited while driving. A message appears on the screen when the vehicle is moving and the operation is canceled.

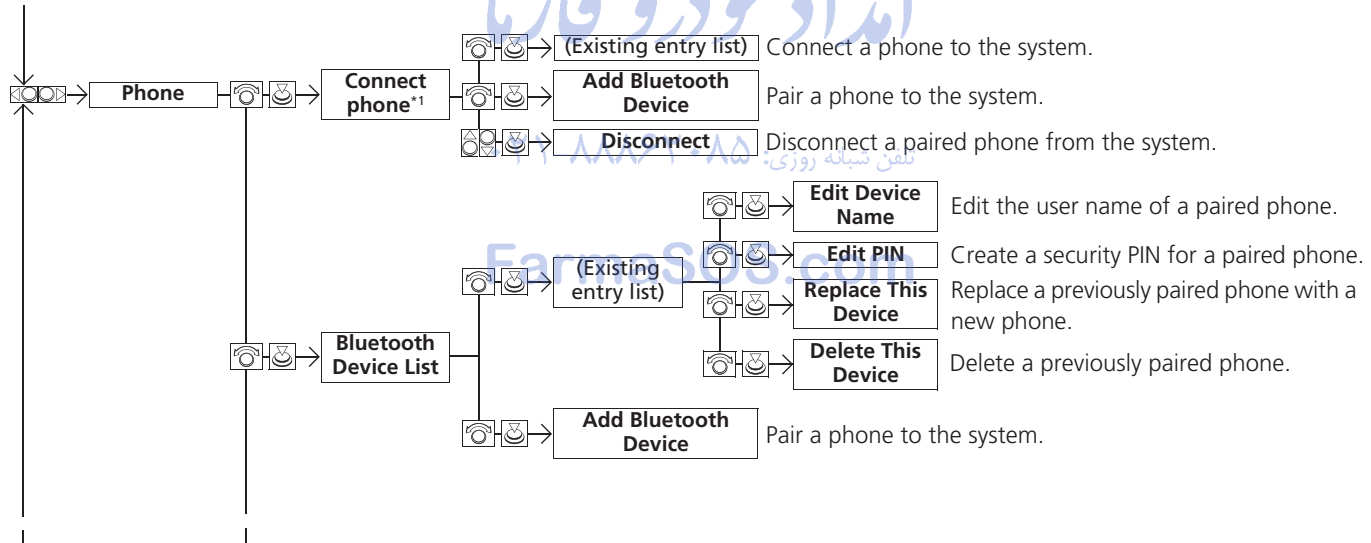

*1: Appears when a phone has already been paired to HFL.

Features

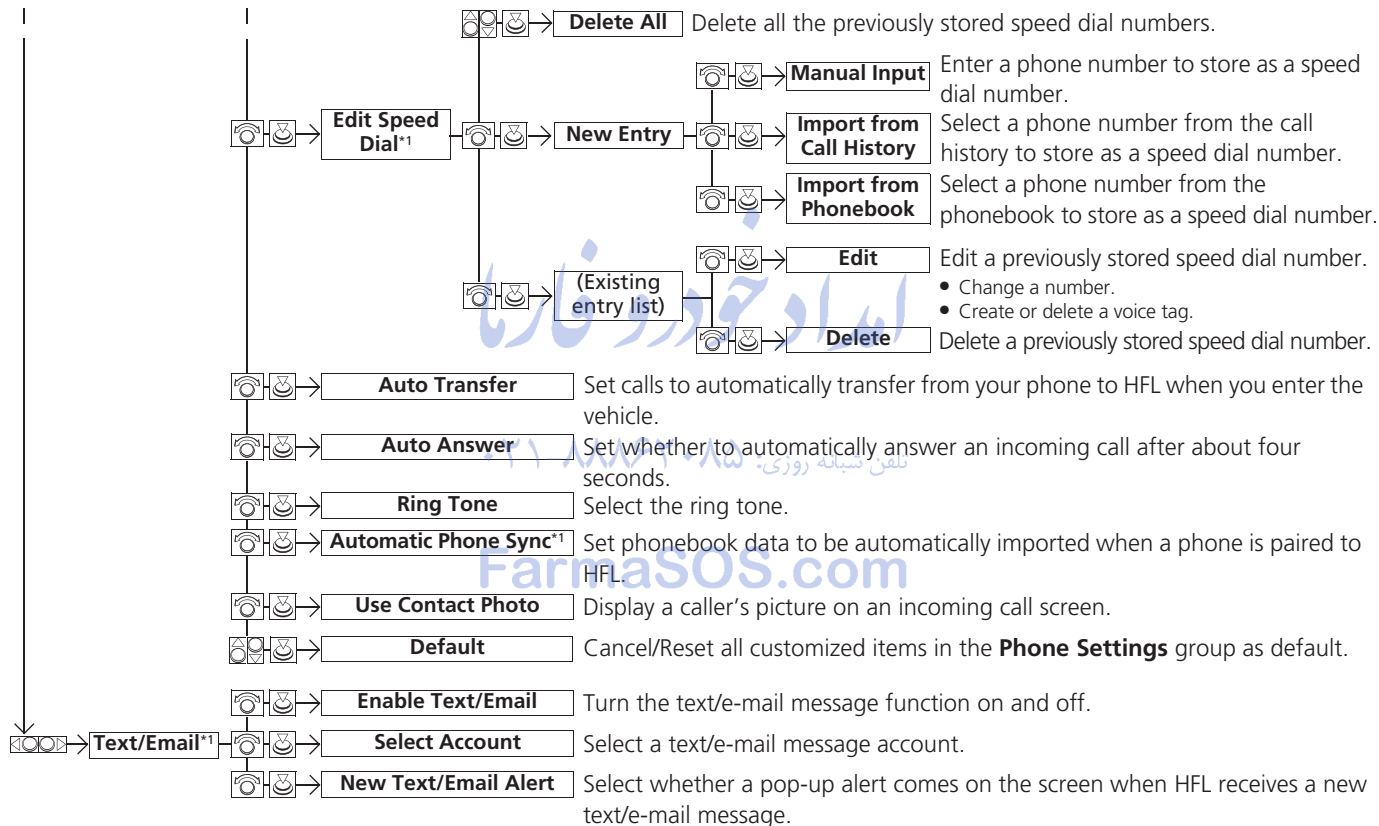

*1: Appears only when a phone is connected to HFL.

■ Phone screen



1. Press the **PHONE** button.
2. Press the **MENU** button to display the menu items.

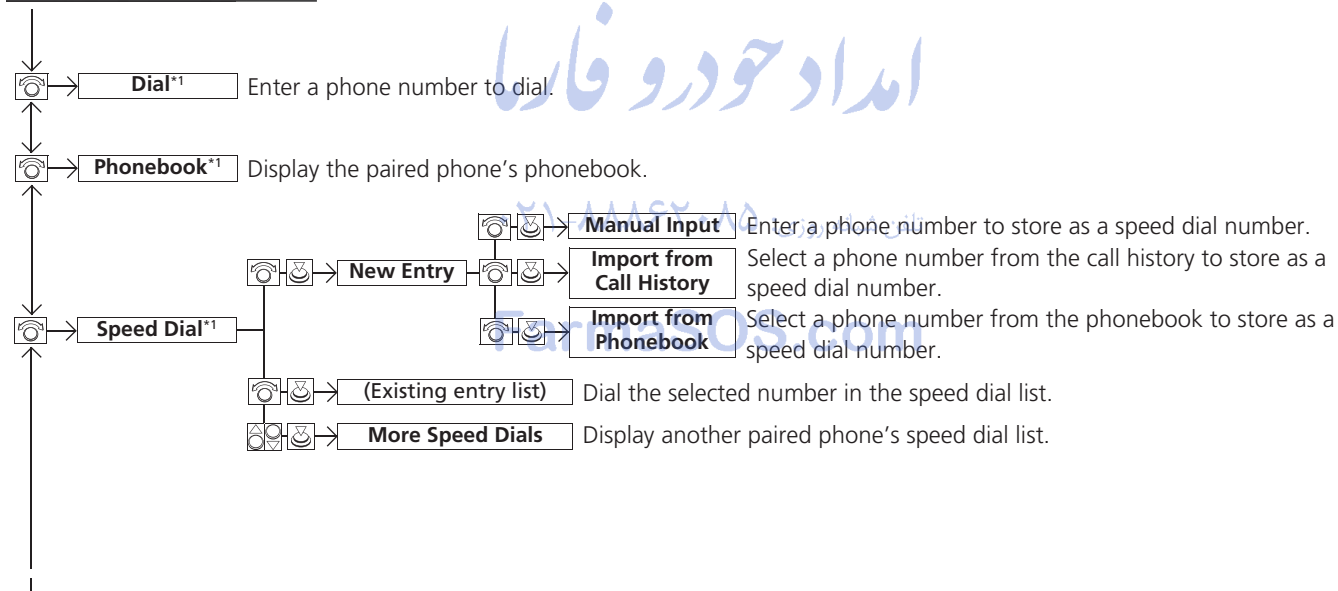

*1: Appears only when a phone is connected to HFL.

امداد خودرو فارسی

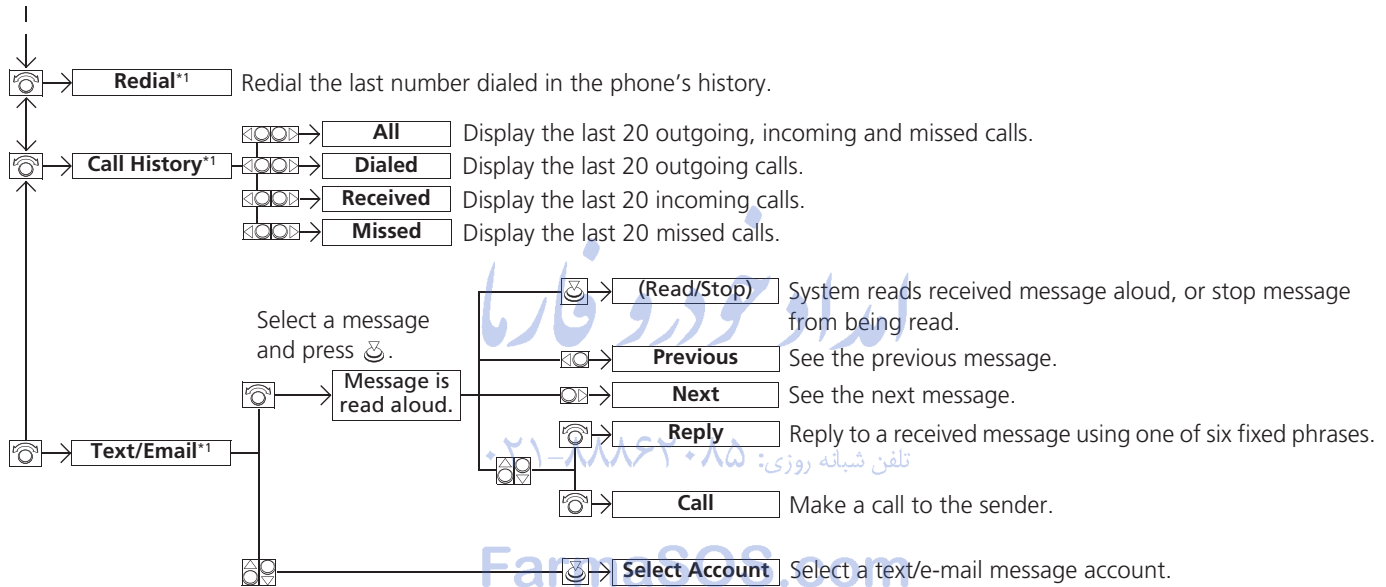

*1: Appears only when a phone is connected to HFL.

Phone Setup

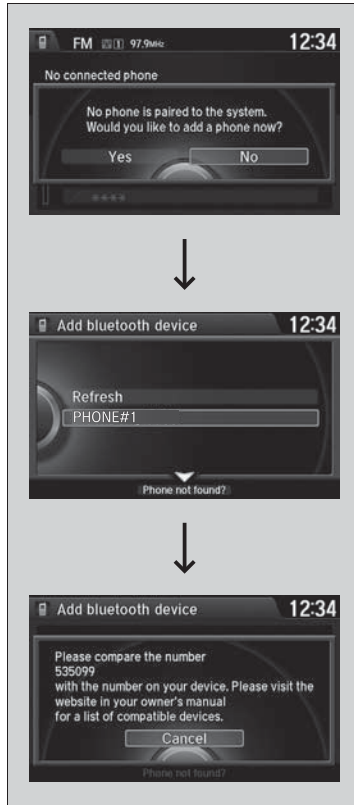

■ To pair a cell phone (when there is no phone paired to the system)

1. Press the **PHONE** button.
2. Rotate to select **Yes**, then press .
3. Make sure your phone is search or discoverable mode, then press .
 - ▶ HFL automatically searches for a *Bluetooth* device.
4. When your phone appears on the list, select it by pressing .
 - ▶ If your phone does not appear, you can select **Refresh** to search again.
 - ▶ If your phone still does not appear, move to select **Phone Not Found?** and search for *Bluetooth* devices using your phone. From your phone, select **HandsFreeLink**.
5. HFL gives you a pairing code on the audio/information screen.
 - ▶ Confirm if the pairing code on the screen and your phone match. This may vary by phone.
6. You will receive a notification on the screen if pairing is successful.

☒ Phone Setup

Your *Bluetooth*-compatible phone must be paired to HFL before you can make and receive hands-free calls.

Phone Pairing Tips:

- You cannot pair your phone while the vehicle is moving.
- Up to six phones can be paired.
- Your phone's battery may drain faster when it is paired to HFL.
- If your phone is not ready for pairing or not found by the system within three minutes, the system will time out and returns to idle.

Once you have paired a phone, you can see it displayed on the screen with one or two icons on the right side.

These icons indicate the following:

: The phone can be used with HFL.

: The phone is compatible with *Bluetooth*® Audio.







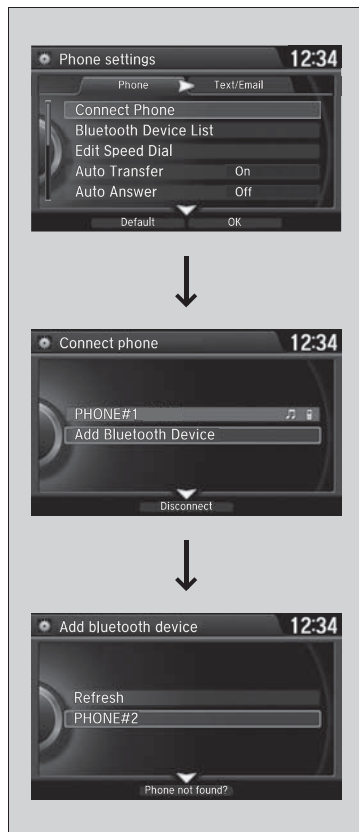

When pairing is completed, an **Automatic Phone Sync** prompt appears. Select **On** if you want your call history and phonebook automatically imported to HFL.

☒ Changing the Automatic Phone Sync setting P. 392

Continued



■ **To pair a cell phone (when a phone has already been paired to the system)**

1. Press the **SETTINGS** button.
2. Rotate  to select **Phone Settings**, then press .
3. Move  or  to select the **Phone** tab.
4. Rotate  to select **Connect Phone**, then press .
 - ▶ Repeat the procedure to select **Add Bluetooth Device**.
5. Make sure your phone is in search or discoverable mode, then press .
 - ▶ HFL automatically searches for a *Bluetooth* device.
6. When your phone appears on the list, select it by pressing .
 - ▶ If your phone does not appear, you can select **Refresh** to search again.
 - ▶ If your phone still does not appear, move  to select **Phone Not Found?** and search for *Bluetooth* devices using your phone. From your phone, select **HandsFreeLink**.
7. HFL gives you a pairing code on the audio/information screen.
 - ▶ Confirm if the pairing code on the screen and your phone match. This may vary by phone.
8. You will receive a notification on the screen if pairing is successful.

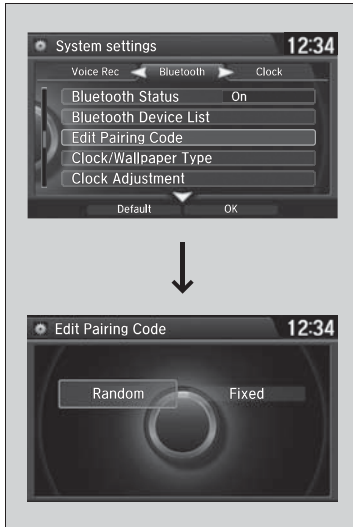

■ To change the pairing code setting

1. Press the **SETTINGS** button.
2. Rotate to select **System Settings**, then press .
3. Move or to select the **Bluetooth** tab.
4. Rotate to select **Edit Pairing Code**, then press .
5. Rotate to select **Fixed** or **Random**, then press .

▶ To change the pairing code setting

The pairing code may be six or four digits depending on your phone.

The default pairing code is **0000** until you change the setting.

To create your own, select **Fixed**, and delete the current code, then enter a new one.

For a randomly generated pairing code each time you pair a phone, select **Random**.

امداد خودرو فارما

تلفن شبانه روزی: ۰۲۱-۸۸۸۶۲۰۸۵

FarmaSOS.com

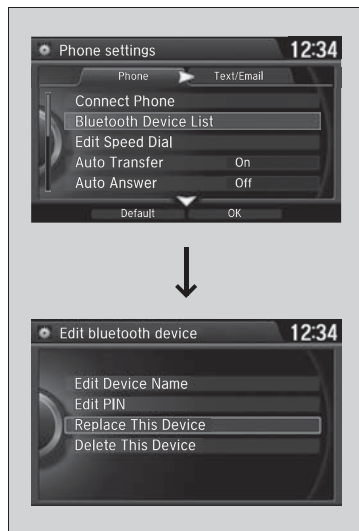

■ **To replace an already-paired phone with a new phone**

1. Press the **SETTINGS** button.
2. Rotate to select **Phone Settings**, then press .
3. Move or to select the **Phone** tab.
4. Rotate to select **Bluetooth Device List**, then press .
5. Rotate to select a paired phone you want to replace, then press .
6. Rotate to select **Replace This Device**, then press .
7. HFL enters the pairing process and searches a new phone.
 - ▶ Follow the prompts to pair a new phone.
8. You will receive a notification on the screen if pairing is successful.

▶ To replace an already-paired phone with a new phone

The replaced phone will keep the same speed dial entries, call history, and security PIN information from the previously paired phone.

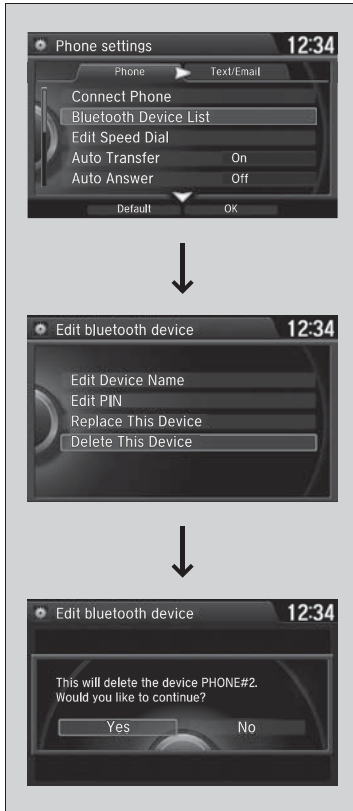

■ To delete a paired phone

1. Press the **SETTINGS** button.
2. Rotate to select **Phone Settings**, then press .
3. Move or to select the **Phone** tab.
4. Rotate to select **Bluetooth Device List**, then press .
5. Rotate to select a phone you want to delete, then press .
6. Rotate to select **Delete This Device**, then press .
7. You will receive a confirmation message on the screen. Rotate to select **Yes**, then press .
8. You will receive a notification on the screen if it is successful.

FarmaSOS.com

To Set Up a Text/E-Mail Message Options

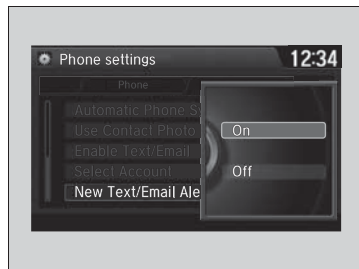
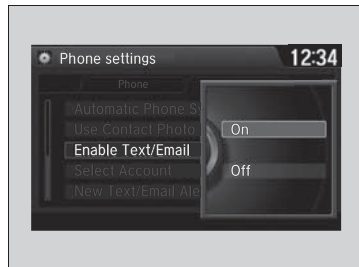

■ To turn on or off the text/e-mail message function

1. Press the **SETTINGS** button.
2. Rotate to select **Phone Settings**, then press .
3. Move or to select the **Text/Email** tab.
4. Rotate to select **Enable Text/Email**, then press .
 - ▶ A pop-up menu appears on the screen.
5. Rotate to select **On** or **Off**, then press .

■ To turn on or off the text/e-mail message notice

1. Press the **SETTINGS** button.
2. Rotate to select **Phone Settings**, then press .
3. Move or to select the **Text/Email** tab.
4. Rotate to select **New Text/Email Alert**, then press .
 - ▶ A pop-up menu appears on the screen.
5. Rotate to select **On** or **Off**, then press .







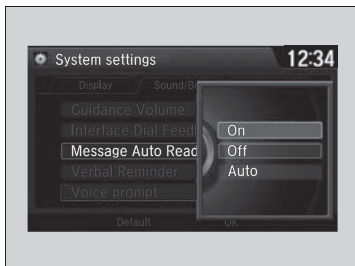

▶▶ To turn on or off the text/e-mail message notice

On: A pop-up notification comes on every time you receive a new message.

Off: The message you receive is stored in the system without notification.



■ To set up the auto reading option

1. Press the **SETTINGS** button.
2. Rotate  to select **System Settings**, then press .
3. Move  or  to select the **Sound/Beep** tab.
4. Rotate  to select **Message Auto Reading**, then press .
 - ▶ A pop-up menu appears on the screen.
5. Rotate  to select **On**, **Off** or **Auto**, then press .

▶ To set up the auto reading option

- On:** A text/e-mail message is always read aloud.
- Off:** A text/e-mail message is not read aloud.
- Auto:** A text/e-mail message is read aloud only when driving.

تلفن شبانه روزی: ۰۲۱-۸۸۸۶۲۰۸۵

FarmaSOS.com

To Create a Security PIN

You can protect each of the six cell phones with a security PIN.

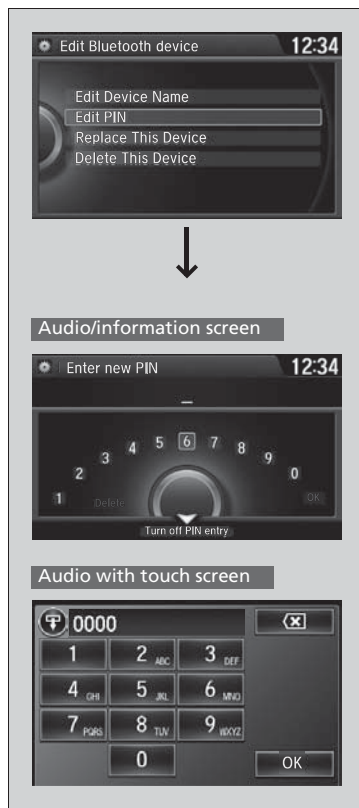

1. Press the **SETTINGS** button.
2. Rotate to select **Phone Settings**, then press .
3. Move or to select the **Phone** tab.
4. Rotate to select **Bluetooth Device List**, then press .
5. Rotate to select a phone you want to add a security PIN to, then press .
6. Rotate to select **Edit PIN**, then press .
7. Enter a new four-digit number.

▶ Audio/information screen

Rotate to select, then press .

Move to delete. Rotate to select **OK** to enter the security PIN.

▶ Audio with touch screen

You can also enter a number using the icons.

8. Re-enter the four-digit number.
 - ▶ The screen returns to the screen in step 4.

▶▶ To Create a Security PIN

If the phone is already security PIN protected, you need to enter the current security PIN before clearing the PIN or creating a new one.

Editing User Name



Audio/information screen



Audio with touch screen



Edit the user name of a paired phone as follows:

1. Press the **SETTINGS** button.
2. Rotate to select **Phone Settings**, then press .
3. Move or to select the **Phone** tab.
4. Rotate to select **Bluetooth Device List**, then press .
5. Rotate to select a phone you want to edit, then press .
6. Rotate to select **Edit Device Name**, then press .
7. Enter a new name of the phone.

▶ Audio/information screen

Rotate to select, then press .

Move to delete. Rotate or move to select **OK** then press to enter the name.

▶ Audio with touch screen

You can also enter a name using the icons.

Editing User Name

Audio/information screen



Select to enter symbols.

Automatic Transferring

If you get into the vehicle while you are on the phone, the call can be automatically transferred to HFL.

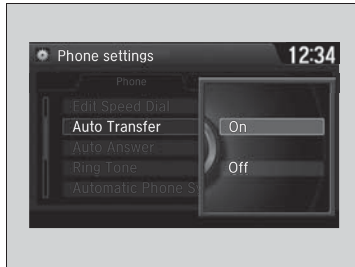

1. Press the **SETTINGS** button.
2. Rotate to select **Phone Settings**, then press .
3. Move or to select the **Phone** tab.
4. Rotate to select **Auto Transfer**, then press .
5. Rotate to select **On**, then press .

Auto Answer

You can set HFL to automatically answer an incoming call in four seconds. تلفن شبانه روزی: ۰۲۱-۸۸۸۶۲۰۸۵

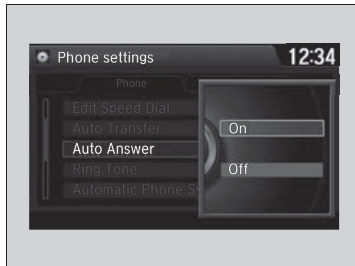

1. Press the **SETTINGS** button.
2. Rotate to select **Phone Settings**, then press .
3. Move or to select the **Phone** tab.
4. Rotate to select **Auto Answer**, then press .
5. Rotate to select **On**, then press .

Ring Tone

You can change the ring tone setting.



1. Press the **SETTINGS** button.
2. Rotate to select **Phone Settings**, then press .
3. Move or to select the **Phone** tab.
4. Rotate to select **Ring Tone**, then press .
5. Rotate to select **Fixed**, **Mobile Phone** or **Off**, then press .

Use Contact Photo

You can display a caller's picture on an incoming call screen.



1. Press the **SETTINGS** button.
2. Rotate to select **Phone Settings**, then press .
3. Move or to select the **Phone** tab.
4. Rotate to select **Use Contact Photo**, then press .
5. Rotate to select **On** or **Off**, then press .

Ring Tone

Fixed: The fixed ring tone sounds from the speaker.

Mobile Phone: The ring tone stored in the connected cell phone sounds from the speaker.

Off: No ring tones sound from the speaker.

Automatic Import of Cellular Phonebook and Call History

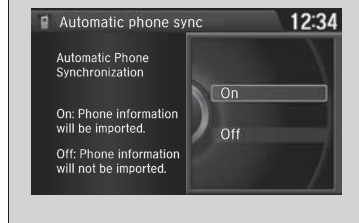
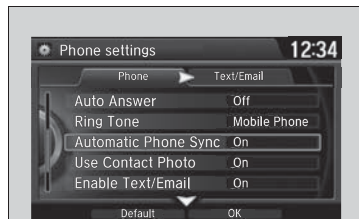

When Automatic Phone Sync is set to On:

When your phone is paired, the contents of its phonebook and call history are automatically imported to HFL.

Changing the Automatic Phone Sync setting

1. Press the **SETTINGS** button.
2. Rotate to select **Phone Settings**, then press .
3. Move or to select the **Phone** tab.
4. Rotate to select **Automatic Phone Sync**, then press .
5. Rotate to select **On** or **Off**, then press .

Automatic Import of Cellular Phonebook and Call History

When you select a person from the list in the cellular phonebook, you can see up to three category icons. The icons indicate what types of numbers are stored for that name.

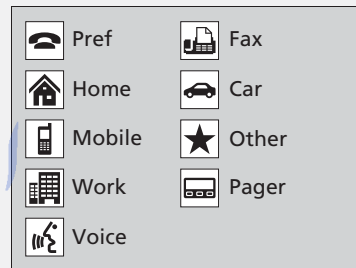

On some phones, it may not be possible to import the category icons to HFL.

The phonebook is updated after every connection. Call history is updated after every connection or call.

Speed Dial

Up to 20 speed dial numbers can be stored per phone.

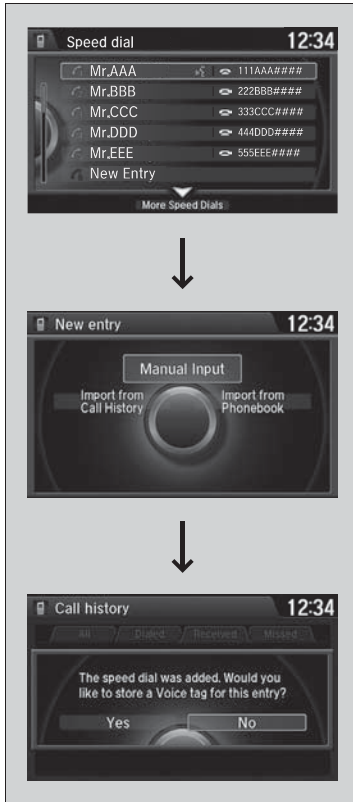

To store a speed dial number:

1. Press the **PHONE** button.
2. Press the **MENU** button.
3. Rotate to select **Speed Dial**, then press .
 - ▶ Repeat the procedure to select **New Entry**.
4. Rotate to select a place to choose a number from, then press .
 - From **Import from Call History**:
 - ▶ Select a number from the call history.
 - From **Manual Input**:
 - ▶ Input the number manually.
 - From **Import from Phonebook**:
 - ▶ Select a number from the linked cell phone's imported phonebook.
5. When the speed dial is successfully stored from **Import from Call History** or **Import from Phonebook**, you are asked to create a voice tag for the number. Rotate to select **Yes** or **No**, then press .
6. Using the button, follow the prompts to store a voice tag for the speed dial entry.

Speed Dial

When a voice tag is stored, press the button to call the number using the voice tag. Say "Call" and the voice tag name.



■ **To add a voice tag to a stored speed dial number**

1. Press the **SETTINGS** button.
2. Rotate to select **Phone Settings**, then press .
3. Move or to select the **Phone** tab.
4. Rotate to select **Edit Speed Dial**, then press .
5. Select an existing speed dial entry.
 - ▶ From the pop-up menu, rotate to select **Edit**, then press .
6. Rotate to select **Voice Tag**, then press .
 - ▶ From the pop-up menu, rotate to select **Record**, then press .
7. Using the button, follow the prompts to complete the voice tag.

» Speed Dial

Avoid using duplicate voice tags. Avoid using “home” as a voice tag. It is easier for HFL to recognize a longer name. For example, use “John Smith” instead of “John.”

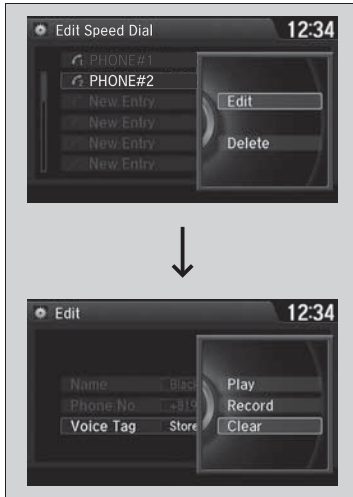

■ To delete a voice tag

1. Press the **SETTINGS** button.
2. Rotate to select **Phone Settings**, then press .
3. Move or to select the **Phone** tab.
4. Rotate to select **Edit Speed Dial**, then press .
5. Select an existing speed dial entry.
 - ▶ From the pop-up menu, rotate to select **Edit**, then press .
6. Rotate to select **Voice Tag**, then press .
 - ▶ From the pop-up menu, rotate to select **Clear**, then press .
7. You will receive a confirmation message on the screen. Rotate to select **Yes**, then press .



■ To delete a speed dial

1. Press the **SETTINGS** button.
2. Rotate to select **Phone Settings**, then press .
3. Move or to select the **Phone** tab.
4. Rotate to select **Edit Speed Dial**, then press .
5. Select an existing speed dial entry.
 - ▶ From the pop-up menu, rotate to select **Delete**, then press .
6. You will receive a confirmation message on the screen. Rotate to select **Yes**, then press .

Continued

Phonebook Phonetic Modification

Add phonetic modifications or a new voice tag to the phone's contact name so that it is easier for HFL to recognize voice commands.

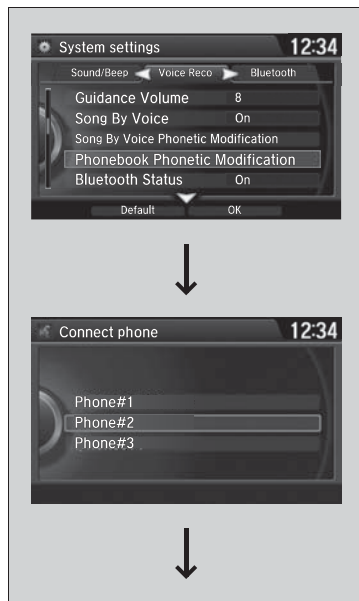

To add a new voice tag

1. Press the **SETTINGS** button.
2. Rotate to select **System Settings**, then press .
3. Move or to select the **Voice Reco** tab.
4. Rotate to select **Phonebook Phonetic Modification**, then press .
5. Rotate to select the phone you want to add phonetic modification to, then press .

Phonebook Phonetic Modification

Phonetic Modification is grayed out when **Song By Voice** is set to **Off**.

You can store up to 20 phonetic modification items.

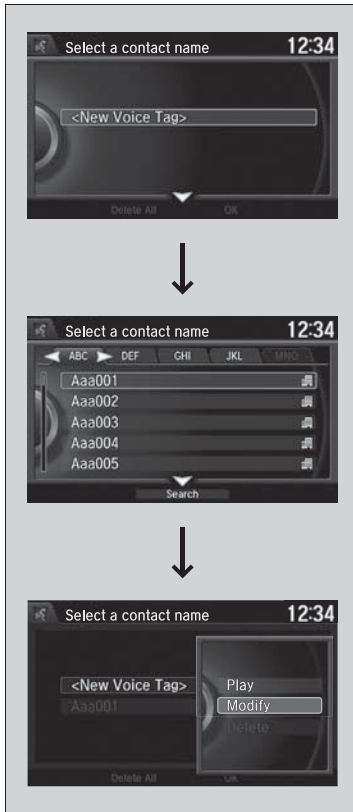

6. Rotate to select **New Voice Tag**, then press .
7. Move or and rotate to select a contact name, then press .
 - ▶ The pop-up menu appears on the screen.
8. Rotate to select **Modify**, then press .
9. Using the button, follow the prompts to complete the voice tag.
10. You will receive a confirmation message on the screen. Rotate to select **OK**, then press .

امداد خودرو فارما

تلفن شبانه روزی: ۰۲۱-۸۸۸۶۲۰۸۵

FarmaSOS.com

Features



■ To modify a voice tag

1. Press the **SETTINGS** button.
2. Rotate to select **System Settings**, then press .
3. Move or to select the **Voice Reco** tab.
4. Rotate to select **Phonebook Phonetic Modification**, then press .
5. Rotate to select the phone you want to add phonetic modification to, then press .
6. Rotate to select a contact name you want to modify, then press .
 - ▶ The pop-up menu appears on the screen.
7. Rotate to select **Modify**, then press .
8. Using the button, follow the prompts to complete the voice tag. تلفن شماره
9. You will receive a confirmation message on the screen. Rotate to select **OK**, then press .

▶ Phonebook Phonetic Modification

You can only modify or delete contact names for the currently connected phone.



■ To delete a modified voice tag

1. Press the **SETTINGS** button.
2. Rotate to select **System Settings**, then press .
3. Move or to select the **Voice Reco** tab.
4. Rotate to select **Phonebook Phonetic Modification**, then press .
5. Rotate to select the phone you want to delete phonetic modification, then press .
6. Rotate to select a contact name you want to delete, then press .
 - ▶ The pop-up menu appears on the screen.
7. Rotate to select **Delete**, then press .
8. Move and rotate to select **OK**, then press .

FarmaSOS.com



■ **To delete all modified voice tags**

1. Press the **SETTINGS** button.
2. Rotate to select **System Settings**, then press .
3. Move or to select the **Voice Reco** tab.
4. Rotate to select **Phonebook Phonetic Modification**, then press .
5. Rotate to select the phone you want to delete phonetic modification, then press .
 - ▶ The contact name list appears.
6. Move and rotate to select **Delete All**, then press .
7. You will receive a confirmation message on the screen. Rotate to select **Yes**, then press .

FarmaSOS.com

Making a Call



You can make calls by inputting any phone number, or by using the imported phonebook, call history, speed dial entries, or redial.

☒ Making a Call

Any voice-tagged speed dial entry, phonebook name, or number can be dialed by voice from most screens. Press the  button and say "Call" and the phonebook name, phone number, or stored voice tag.

The maximum range between your phone and vehicles is 30 feet (10 meters).

Once a call is connected, you can hear the voice of the person you are calling through the audio speakers.

امداد خودرو فارما

تلفن شبانه روزی: ۰۲۱-۸۸۸۶۲۰۸۵

FarmaSOS.com



■ To make a call using the imported phonebook

1. Press the **PHONE** button.
2. Press the **MENU** button.
3. Rotate to select **Phonebook**, then press .
4. The phonebook is stored alphabetically. Move to **Search**.
 - ▶ You can use the keyboard on the touch screen for an alphabetical search.
5. Rotate to select a number, then press .
 - ▶ Dialing starts automatically.

▶ To make a call using the imported phonebook

This function is disabled while the vehicle is moving. However, you can call a stored voice-tagged speed dial number, phonebook name, or number using voice commands.

- ▶ **Limitations for Manual Operation** P. 376
- ▶ **Speed Dial** P. 393

You can use the keyboard on the audio with touch screen for an alphabetical search.

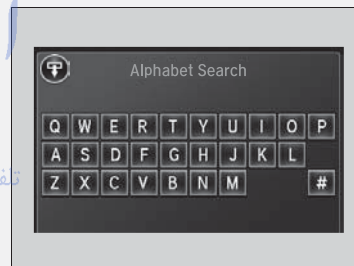



■ **To make a call using a phone number**

1. Press the **PHONE** button.
2. Press the **MENU** button.
3. Rotate to select **Dial**, then press .
4. Rotate to select a number, then press .
5. Rotate to select , then press .
 - ▶ Dialing starts automatically.

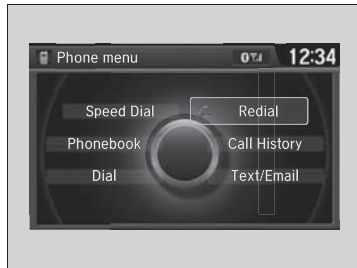

■ **To make a call using redial**

1. Press the **PHONE** button.
2. Press the **MENU** button.
3. Rotate to select **Redial**, then press .
 - ▶ Dialing starts automatically.

▶ To make a call using a phone number

This function is disabled while the vehicle is moving. However, you can call a stored voice-tagged speed dial number, phonebook name, or number using voice commands.

- ▶ **Limitations for Manual Operation** P. 376
- ▶ **Speed Dial** P. 393

You can use the keyboard on the audio with touch screen to input numbers. Select numbers, then to start dialing.



FarmaSOS.com

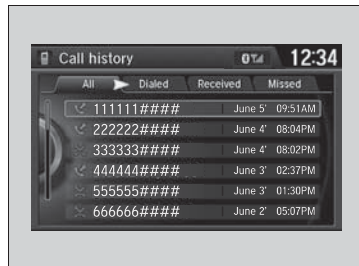

■ To make a call using the call history

1. Press the **PHONE** button.
2. Press the **MENU** button.
3. Rotate to select **Call History**, then press .
4. Move or to select **All**, **Dialed**, **Received**, and **Missed**.
5. Rotate to select a number, then press .
 - ▶ Dialing starts automatically.

■ To make a call using a speed dial entry

1. Press the **PHONE** button.
2. Press the **MENU** button.
3. Rotate to select **Speed Dial**, then press .
4. Rotate to select a number, then press .
 - ▶ Dialing starts automatically.

▶▶ To make a call using the call history

The call history displays the last 20 dialed, received, or missed calls.
(Appears only when a phone is connected to HFL.)

These icons next to the number indicate the following:

- : Dialed calls.
- : Received calls.
- : Missed calls.

▶▶ To make a call using a speed dial entry

Move to select **More Speed Dials** to view another paired phone's speed dial list. You can make a call from that list using the currently connected phone.

When a voice tag is stored, press the button to call the number using the voice tag.



Speed Dial P. 393

Any voice-tagged speed dial entry, phonebook name or number can be dialed by voice from any screen. Press the button and follow the prompts.

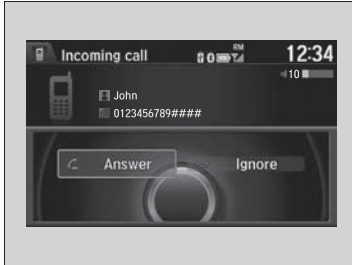
Receiving a Call



When there is an incoming call, an audible notification sounds (if activated) and the **Incoming call** screen appears.

Press the  button to answer the call.
Press the  button to decline or end the call.

امداد خودرو فارما

تلفن شبانه روزی: ۰۲۱-۸۸۸۶۲۰۸۵

FarmaSOS.com

Receiving a Call



Call Waiting

Press the  button to put the current call on hold to answer the incoming call.

Press the  button again to return to the current call.

Ignore the incoming call if you do not want to answer it.

Press the  button if you want to hang up the current call.

You can select the icons on the audio with touch screen instead of the  and  buttons.



Options During a Call

The following options are available during a call.

Mute: Mute your voice.

Transfer: Transfer a call from HFL to your phone.

Touch Tones: Send numbers during a call. This is useful when you call a menu-driven phone system.

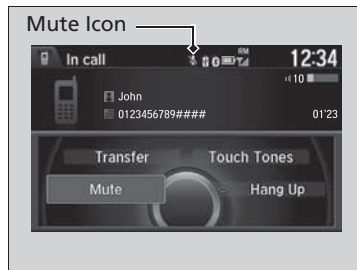

The available options are shown on the Phone screen.

Rotate  to select the mute option, then press .

- ▶ The mute icon appears when **Mute** is selected. Select **Mute** again to turn it off.

Options During a Call

Touch Tones: Available on some phones.

You can select the icons on the audio with touch screen.



تلفن شبانه روزی: ۰۲۱-۸۸۸۶۲۰۸۵

FarmaSOS.com

Receiving a Text/E-Mail Message

HFL can display newly received text/e-mail messages as well as 20 of the most recently received messages on a linked cell phone. Each received message can be read aloud and replied to using a fixed common phrase.

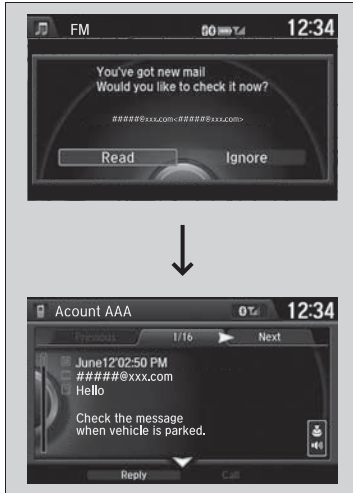

1. A pop-up appears and notifies you of a new text/e-mail message.
2. Rotate to select **Read** to listen to the message, then press .
 - ▶ The text/e-mail message is displayed. The system automatically starts reading out the message.
3. To discontinue the message read-out, press .

تلفن شبانه روزی: ۰۲۱-۸۸۸۶۲۰۸۵

FarmaSOS.com

Receiving a Text/E-Mail Message

The system does not display any received messages while you are driving. You can only hear them read aloud.

With some phones, you may be able to display up to 20 most recent text/e-mail messages.

State or local laws may limit your use of the HFL text/e-mail message feature. Only use the text/e-mail message feature when conditions allow you to do so safely.

When you receive a text/e-mail message for the first time since the phone is paired to HFL, you are asked to turn the **New Text/Email Alert** setting to **On**.

▶ **To turn on or off the text/e-mail message notice** P. 386

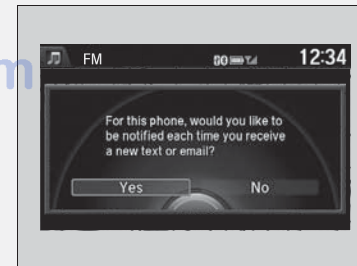

Continued

Selecting a Mail Account

If a paired phone has text message or mail accounts, you can select one of them to be active and receive notifications.



1. Press the **SETTINGS** button.
2. Rotate to select **Phone Settings**, then press .
3. Move or to select the **Text/Email** tab.
4. Rotate to select **Select Account**, then press .
5. Rotate to select **Text message** or an e-mail account you want, then press .

Selecting a Mail Account

You can also select a mail account from the folder list screen or the message list screen.

Move to select **Select Account**, then press .

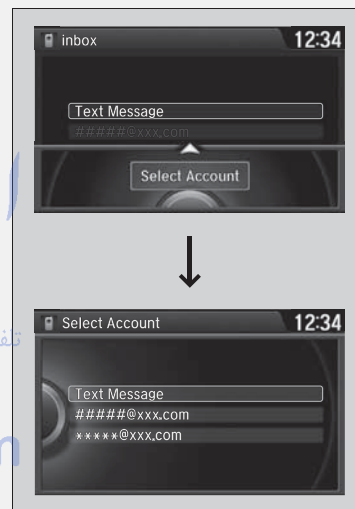





You can only receive notifications from one text message or mail account at a time.

Displaying Messages



■ Displaying text messages

1. Press the **PHONE** button.
2. Press the **MENU** button.
3. Rotate  to select **Text/Email**, then press .
- ▶ Select account if necessary.
4. Rotate  to select a message, then press .
- ▶ The text message is displayed. The system automatically starts reading the message aloud.



تلفن شبانه روزی: ۰۲۱-۸۸۸۶۲۰۸۵

FarmaSOS.com

■ Displaying Messages





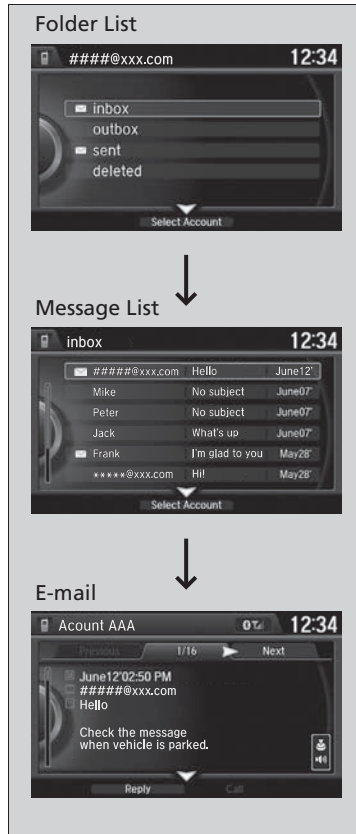

The  icon appears next to an unread message.

If you delete a message on the phone, the message is also deleted in the system. If you send a message from the system, the message goes to your phone's outbox.

To see the previous or next message, move  or  on the text message screen.



■ Displaying e-mail messages

1. Press the **PHONE** button.
2. Press the **MENU** button.
3. Rotate  to select **Text/Email**, then press .
4. Rotate  to select a folder, then press .
5. Rotate  to select a message, then press .
 - ▶ The e-mail is displayed. The system automatically starts reading the message aloud.

▶▶ Displaying e-mail messages

Received text/e-mail messages may appear in the message list screen at the same time. In this case, text messages are titled **No subject**.

امداد خودرو فارما

تلفن شبانه روزی: ۰۲۱-۸۸۸۶۲۰۸۵

FarmaSOS.com

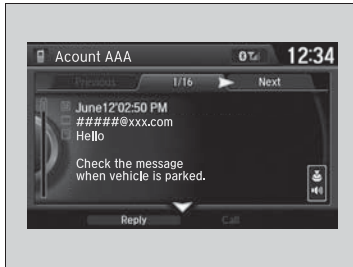

■ Read or stop reading a message

1. Go to the text/e-mail message screen.
 - ▶ The system automatically starts reading the message aloud.
 - ▶ **Displaying Messages** P. 409
2. Press to stop reading. Press again to start reading the message from the beginning.

■ Reply to a message

1. Go to the text/e-mail message screen.
 - ▶ The system automatically starts reading the message aloud.
 - ▶ **Displaying Messages** P. 409
2. Move and rotate to select **Reply**, then press .
3. Rotate to select the reply message, then press .
 - ▶ The pop-up menu appears on the screen.
4. Select **Send** to send the message.
 - ▶ **Complete** appears on the screen when the reply message was successfully sent.

▶ Reply to a message

The available fixed reply messages are as follows:

- **Talk to you later, I'm driving.**
- **I'm on my way.**
- **I'm running late.**
- **OK**
- **Yes**
- **No**

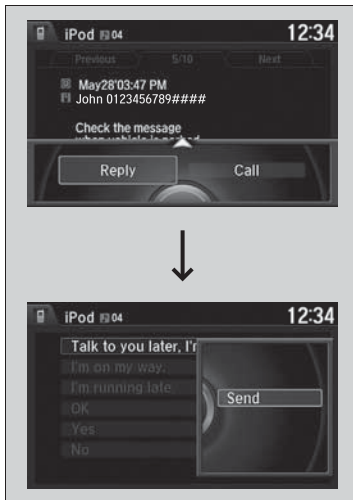

You cannot add, edit, or delete reply messages.



Continued



■ Making a call to a sender

1. Go to the text message screen.
 - ▶ The system automatically starts reading the message aloud.
2. Move  and rotate  to select **Call**, then press .

امداد خودرو فارما

تلفن شبانه روزی: ۰۲۱-۸۸۸۶۲۰۸۵





FarmaSOS.com

When you set the power mode to ON, the compass self-calibrates, and the compass display appears.

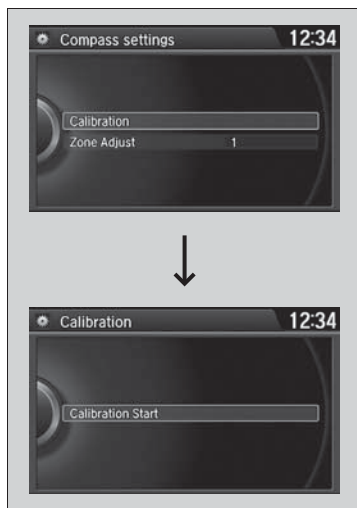
Compass Calibration

If the compass indicates the wrong direction, or the **CAL** indicator blinks, you need to manually calibrate the system.



1. Set the power mode to ON.
2. On the top screen of any audio source, press and hold  for five seconds.
 - ▶ The display switches to the **Compass Settings** screen.
3. Rotate  to select **Calibration**, then press .
4. When the display changes to **Calibration Start**, press .
5. Drive the vehicle slowly in two circles.
 - ▶ The compass starts to show a direction after the calibration. The **CAL** indicator goes off.

Compass*

Compass operation can be affected under the following conditions:

- Driving near power lines or stations
- Crossing a bridge
- Passing a large vehicle, or driving near a large object that can cause a magnetic disturbance
- When accessories such as antennas and roof racks are mounted by magnets

Compass Calibration





Calibrate the compass in an open area.

While setting the compass, press the **BACK** button to cancel the setting mode and return to the previous screen.

* Not available on all models

Compass Zone Selection



1. Set the power mode to ON.
2. On the top screen of any audio source, press and hold  for five seconds.
 - ▶ The display switches to the **Compass Settings** screen.
3. Rotate  to select **Zone Adjust**, then press .
 - ▶ The display shows the current zone number.
4. Rotate  to select the zone number of your area (See Zone Map), then press .

Compass Zone Selection

The zone selection is done to compensate the variation between magnetic north and true north.

If the calibration starts while the audio system is in use, the display returns to normal after the calibration is completed.

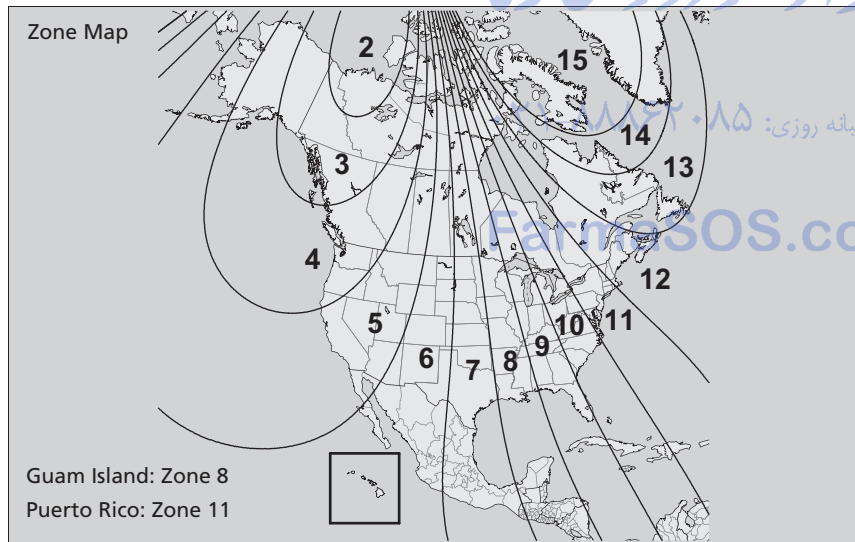

Driving

This chapter discusses driving, refueling, and information on items such as accessories.

امداد خودرو فارما

تلفن شبانه روزی: ۰۲۱-۸۸۸۶۲۰۸۵

Before Driving

Driving Preparation	416
Maximum Load Limit.....	419

Towing a Trailer

Towing Preparation.....	421
Driving Safely with a Trailer.....	423
Towing Your Vehicle.....	424

When Driving

Starting the Engine	425, 427
Precautions While Driving.....	431
Automatic Transmission/CVT*	432
Shifting	433, 435, 439, 441
ECON Button	444

Cruise Control*	445
Adaptive Cruise Control (ACC)*	448
Forward Collision Warning (FCW)* ..	456
Lane Departure Warning (LDW)*	460
Vehicle Stability Assist (VSA®), aka Electronic Stability Control (ESC), System	464
LaneWatch™*	466
Tire Pressure Monitoring System (TPMS)...	468
Tire Pressure Monitoring System (TPMS) - Required Federal Explanation	470
Braking	
Brake System	472

Anti-lock Brake System (ABS)	474
Brake Assist System	475

Parking Your Vehicle

When Stopped	476
--------------------	-----

Multi-View Rear Camera

477

Rearview Camera

478	
Refueling	
Fuel Information	479
How to Refuel	480

Fuel Economy

Improving Fuel Economy.....	481
-----------------------------	-----

Accessories and Modifications

482

* Not available on all models

Driving Preparation

Check the following items before you start driving.

Exterior Checks

- Make sure there are no obstructions on the windows, door mirrors, exterior lights, or other parts of the vehicle.
 - ▶ Remove any frost, snow, or ice.
 - ▶ Remove any snow on the roof, as this can slip down and obstruct your field of vision while driving. If frozen solid, remove ice once it has softened.
 - ▶ When removing ice from around the wheels, be sure not to damage the wheel or wheel components.
- Make sure the hood is securely closed.
 - ▶ If the hood opens while driving, your front view will be blocked.
- Make sure the tires are in good condition.
 - ▶ Check air pressure, check for damage and excessive wear.
 - **Checking and Maintaining Tires** P. 523
- Make sure there are no people or objects behind or around the vehicle.
 - ▶ There are blind spots from the inside.

Exterior Checks

NOTICE

When doors are frozen shut, use warm water around the door edges to melt any ice. Do not try to force them open, as this can damage the rubber trim around the doors. When done, wipe dry to avoid further freezing.

Do not pour warm water into the key cylinder. You will be unable to insert the key if the water freezes in the hole.

Heat from the engine and exhaust can ignite flammable materials left under the hood, causing a fire. If you've parked your vehicle for an extended period, inspect and remove any debris that may have collected, such as dried grass and leaves that have fallen or have been carried in for use as a nest by a small animal.

Also check under the hood for leftover flammable materials after you or someone else has performed maintenance on your vehicle.

Interior Checks

- Store or secure all items on board properly.
 - ▶ Carrying too much cargo, or improperly storing it, can affect your vehicle's handling, stability, stopping distance, and tires, and make it unsafe.
 - **Maximum Load Limit** P. 419
- Do not pile items higher than the seat height.
 - ▶ They can block your view and may be thrown forward in the event of sudden braking.
- Do not place anything in the front seat footwells. Make sure to secure the floor mat.
 - ▶ An object or unsecured floor mat can interfere with your brake and accelerator pedal operation while driving.
- If you have any animals on board, do not let them move around in the vehicle.
 - ▶ They may interfere with driving and a crash could occur.
- Securely close and lock all doors and the trunk.
 - **Locking/Unlocking the Doors from the Inside** P. 116
- Adjust your seating position properly.
 - ▶ Adjust the head restraint, too.
 - **Adjusting the Seats** P. 148
 - **Adjusting the Head Restraints** P. 151
- Adjust the mirrors and steering wheel properly for your driving.
 - ▶ Adjust them while sitting in the proper driving position.
 - **Adjusting the Mirrors** P. 146
 - **Adjusting the Steering Wheel** P. 145

Interior Checks

The headlight aim is set by the factory, and does not need to be adjusted. However, if you regularly carry heavy items in the trunk or tow a trailer, have the aiming readjusted at a dealer or by a qualified technician.

- Be sure items placed on the floor behind the front seats cannot roll under the seats.
 - They can interfere with the driver's ability to operate the pedals, the operation of the seats, or the operation of the sensors under the seats.
- Everyone in the vehicle must fasten their seat belt.
 - ✦ **Fastening a Seat Belt** P. 35
- Make sure that the indicators in the instrument panel come on when you start the vehicle, and go off soon after.
 - Always have a dealer check the vehicle if a problem is indicated.
 - ✦ **Indicators** P. 68

امداد خودرو فارما

تلفن شبانه روزی: ۰۲۱-۸۸۸۶۲۰۸۵

FarmaSOS.com

Maximum Load Limit

The maximum load for your vehicle is 850 lbs (385 kg).
See Tire and Loading Information label attached to the driver's doorjamb.

Label Example

TIRE AND LOADING INFORMATION			
SEATING CAPACITY		TOTAL 5 FRONT 2 REAR 3	
The combined weight of occupants and cargo should never exceed 385kg or 850lbs.			
TIRE	SIZE	COLD TIRE PRESSURE	SEE OWNER'S MANUAL FOR ADDITIONAL INFORMATION
FRONT	XXXX/XXXXX XXX	XXXKPA, XXPSI	
REAR		XXXKPA, XXPSI	
SPARE	XXXX/XXXXX XXXX	XXXKPA, XXPSI	

This figure includes the total weight of all occupants, cargo, and accessories, and the tongue load if you are towing a trailer.
Steps for Determining Correct Load Limit -

- (1) Locate the statement "The combined weight of occupants and cargo should never exceed XXX kg or XXX lbs." on your vehicle's placard.
- (2) Determine the combined weight of the driver and passengers that will be riding in your vehicle.
- (3) Subtract the combined weight of the driver and passengers from XXX kg or XXX lbs.
- (4) The resulting figure equals the available amount of cargo and luggage load capacity. For example, if the "XXX" amount equals 1,400 lbs. and there will be five 150 lb. passengers in your vehicle, the amount of available cargo and luggage load capacity is 650 lbs.
(1,400 - 750 (5 x 150) = 650 lbs.)

Maximum Load Limit

⚠ WARNING

Overloading or improper loading can affect handling and stability and cause a crash in which you can be hurt or killed.

Follow all load limits and other loading guidelines in this manual.

Gross Vehicle Weight Rating (GVWR):
The maximum allowable weight of the vehicle, all occupants, all accessories, all cargo, and the tongue load.

📖 Specifications P. 568, 570

Gross Axle Weight Rating (GAWR):
The maximum allowable weight of the vehicle axle.

📖 Specifications P. 568, 570

Continued

- (5) Determine the combined weight of luggage and cargo being loaded on the vehicle. That weight may not safely exceed the available cargo and luggage load capacity calculated in step 4.
- (6) If your vehicle will be towing a trailer, load from your trailer will be transferred to your vehicle. Consult this manual to determine how this reduces the available cargo and luggage load capacity of your vehicle.

In addition, the total weight of the vehicle, all occupants, accessories, cargo, and trailer tongue load must not exceed the Gross Vehicle Weight Rating (GVWR) or the Gross Axle Weight Rating (GAWR). Both are on a label on the driver's doorjamb.

Driving

Load Limits Example

Example1



Max Load
850 lbs
(385 kg)

≧



Passenger Weight
150 lbs x 2 = 300 lbs
(68 kg x 2 = 136 kg)

+



Cargo Weight
550 lbs
(249 kg)

Example2



Max Load
850 lbs
(385 kg)

≧



Passenger Weight
150 lbs x 5 = 750 lbs
(68 kg x 5 = 340 kg)

+



Cargo Weight
100 lbs
(45 kg)

Towing Preparation

Towing Load Limits

Your vehicle can tow a trailer if you carefully observe the load limits, use the proper equipment, and follow the towing guidelines. Check the load limits before driving.

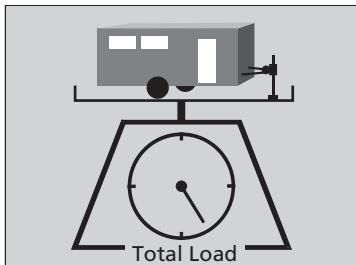

■ Total trailer weight

Maximum allowable weight of the trailer, cargo, and everything in or on it must not exceed 1,000 lbs (450 kg). Towing loads in excess of this can seriously affect vehicle handling and performance and can damage the engine and drivetrain.

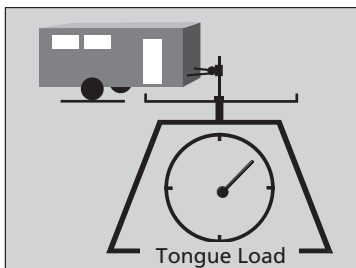

■ Tongue load

The weight of the tongue with a fully loaded trailer on the hitch should be approximately 10% of the total trailer weight.

- Excessive tongue load reduces front tire traction and steering control. Too little tongue load can make the trailer unstable and cause it to sway.
- To achieve a proper tongue load, start by loading 60% of the load toward the front of the trailer and 40% toward the rear. Readjust the load as needed.

Towing Load Limits

⚠ WARNING

Exceeding any load limit or improperly loading your vehicle and trailer can cause a crash in which you can be seriously hurt or killed.

Check the loading of your vehicle and trailer carefully before starting to drive.

Check if all loads are within limits at a public scale. If a public scale is not available, add the estimated weight of your cargo load to the weight of your trailer (as quoted by the manufacturer), and the tongue load.

Break-in Period

Avoid towing a trailer during your vehicle's first 600 miles (1,000 km).

Never exceed the gross weight ratings.

Gross weight information

➤ **Vehicle Specifications** P. 568, 570

■ Towing Equipment and Accessories

Towing equipment varies by the size of your trailer, how much load you are towing, and where you are towing.

■ Hitches

The hitch must be of an approved type and properly bolted to the underbody.

■ Safety chains

Always use safety chains when you tow a trailer. Leave enough slack to allow the trailer to turn corners easily, but do not allow the chains to drag on the ground.

■ Trailer brakes

There are two common types of trailer brakes: surge and electric. Surge brakes are common for boat trailers, since the brakes will get wet. If you choose electric brakes, be sure they are electronically actuated. Do not attempt to attach trailer brakes to your vehicle's hydraulic system, as it will lower braking effectiveness and create a potential hazard.

■ Additional towing equipment

Many states and provinces/territories require special outside mirrors when towing a trailer. Even if mirrors are not required in your locale, you should install special mirrors if visibility is restricted in any way.

■ Trailer light

Trailer lights and equipment must comply with federal, state, province/territory, and local regulations. Check with your local trailer sales or rental agency for the requirements in the area where you plan to tow.

▶ Towing Equipment and Accessories

Make sure that all equipment is properly installed and maintained, and that it meets federal, state, province/territory, and local regulations.

Consult your trailer sales or rental agency if any other items are recommended or required for your towing situation.

The lighting and wiring of trailers can vary by type and brand. If a connector is required, it should only be installed by a qualified technician.

Driving Safely with a Trailer

Things You Need To Know Before Towing a Trailer

- Have the trailer properly serviced and keep it in good condition.
- Make sure that all the weights and load in the vehicle and trailer are within limits.
 - ▣ **Towing Load Limits** P. 421
- Securely attach the hitch, safety chains, and other necessary parts to the trailer.
- Securely store all the items in and on the trailer so that they do not shift while driving.
- Check if the lights and brakes on the trailer are working properly.
- Check the pressures of the trailer tires, including the spare.

Towing Speeds and Gears

- Drive slower than normal.
- Obey posted speed limits for vehicles with trailers.

Automatic transmission/CVT models

- Use the **[D]** position when towing a trailer on level roads.

Turning and Braking

- Turn more slowly and with a wider turning arc than normal.
- Allow more time and distance for braking.
- Do not brake or turn suddenly.

Driving Safely with a Trailer

Parking

In addition to the normal precautions, place wheel chocks at each of the trailer's tires.

امداد خودرو فارما

تلفن شبانه روزی: ۰۲۱-۸۸۸۶۲۰۸۵

FarmaSOS.com

Driving in Hilly Terrain

- Monitor your temperature gauge. If it nears the red (Hot) mark, turn off the heating and cooling system*/climate control system* and reduce speed. Pull to the side of the road safely to cool down the engine if necessary.

Automatic transmission models

- Shift to the **S** position if the transmission shifts frequently.

Towing Your Vehicle

Your vehicle is not designed to be towed behind a motor home. If your vehicle needs to be towed in an emergency, refer to the emergency towing information.

📄 **Emergency Towing** P. 565

تلفن شبانه روزی: ۰۲۱-۸۸۸۶۲۰۸۵

FarmaSOS.com

Models without smart entry system

Starting the Engine

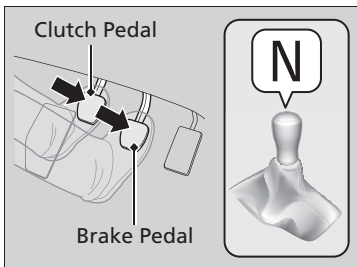
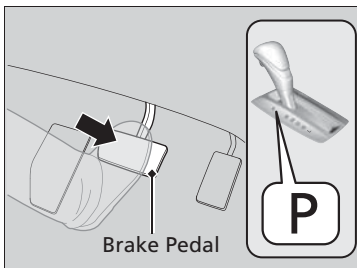
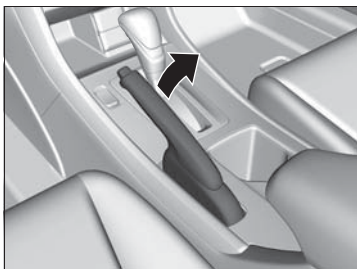

* Not available on all models

1. Make sure the parking brake is applied.

Continuously variable transmission (CVT) models

2. Check that the shift lever is in **P**, then depress the brake pedal.

▶ Although it is possible to start the vehicle in **N**, it is safer to start it in **P**.

Manual transmission models

2. Check that the shift lever is in **N**. Then depress the brake pedal with your right foot, and the clutch pedal with your left foot.

▶ The clutch pedal must be fully depressed to start the engine.

Starting the Engine

Keep your foot firmly on the brake pedal when starting the engine.

The engine is harder to start in cold weather and in thinner air found at altitudes above 8,000 feet (2,400 meters).

When starting the engine in cold weather, turn off all electrical accessories such as the lights, heating and cooling system /*climate control system*/, and rear defogger in order to reduce battery drain.

If you live in a region where winter is extremely cold, an engine block heater will improve starting and warming of the engine. If temperatures consistently below -22°F (-30°C) are expected, the coolant mixture should be changed to a higher concentration to prevent freezing. Consult a dealer for details.

If the exhaust system sounds abnormal or you can smell exhaust gas inside the vehicle, have your vehicle checked by a dealer. There may be a problem with the engine or exhaust system.

Continued

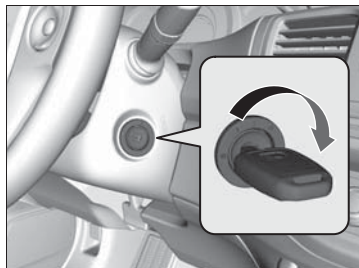

3. Turn the ignition switch to START **III** without depressing the accelerator pedal.

Starting to Drive

Continuously variable transmission (CVT) models

1. Keeping your right foot on the brake pedal, release the parking brake. Check that the parking brake indicator has gone off.
 - **Parking Brake** P. 472
2. Put the shift lever in **D**. Select **R** when reversing.
3. Gradually release the brake pedal and gently depress the accelerator pedal to pull away.

Hill start assist system

Hill start assist keeps the brake engaged briefly to help prevent the vehicle from rolling on inclines as you move your foot from the brake pedal to the accelerator.

Manual transmission models

Depress the clutch pedal, and shift to one of the forward gears when facing uphill, or **R** when facing downhill, then release the brake pedal.

Continuously variable transmission (CVT) models

Move the shift lever to **D**, **S**, or **L*** when facing uphill, or **R** when facing downhill, then release the brake pedal.

* Not available on all models

Starting the Engine

Do not hold the key in START **III** for more than 15 seconds.

- If the engine does not start right away, wait for at least 10 seconds before trying again.
- If the engine starts, but then immediately stops, wait at least 10 seconds before repeating step 3 while gently depressing the accelerator pedal. Release the accelerator pedal once the engine starts.

The immobilizer system protects your vehicle from theft. If an improperly coded key (or other device) is used, the engine's fuel system is disabled.

➤ **Immobilizer System** P. 124

Hill start assist system

Hill start assist may not prevent the vehicle from rolling downhill on a very steep or slippery slope, and does not operate on small inclines.

Hill start assist is not a replacement for the parking brake.

Models with smart entry system

Starting the Engine

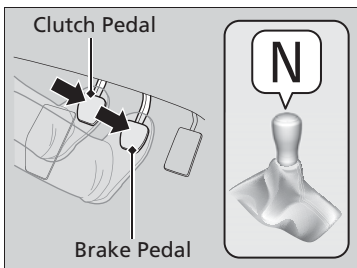
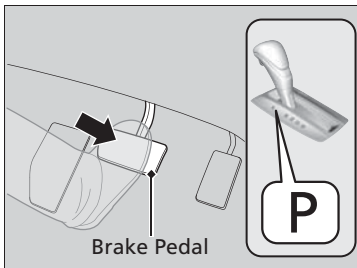
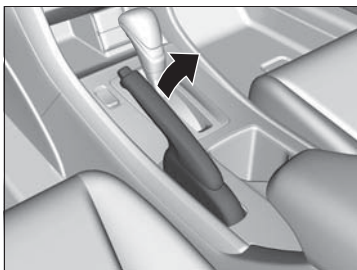

1. Make sure the parking brake is applied.

Automatic transmission/CVT models

2. Check that the shift lever is in **P**, then depress the brake pedal.

- ▶ Although it is possible to start the vehicle in **N**, it is safer to start it in **P**.

Manual transmission models

2. Check that the shift lever is in **N**. Then depress the brake pedal with your right foot, and the clutch pedal with your left foot.

- ▶ The clutch pedal must be fully depressed to start the engine.

Starting the Engine

Keep your foot firmly on the brake pedal when starting the engine.

The engine is harder to start in cold weather and in thinner air found at altitudes above 8,000 feet (2,400 meters).

When starting the engine in cold weather, turn off all electrical accessories such as the lights, climate control system, and rear defogger in order to reduce battery drain.

If you live in a region where winter is extremely cold, an engine block heater will improve starting and warming of the engine. If temperatures consistently below -22°F (-30°C) are expected, the coolant mixture should be changed to a higher concentration to prevent freezing. Consult a dealer for details.

If the exhaust system sounds abnormal or you can smell exhaust gas inside the vehicle, have your vehicle checked by a dealer. There may be a problem with the engine or exhaust system.

The immobilizer system protects your vehicle from theft.

If an improperly coded device is used, the engine's fuel system is disabled.

▶ **Immobilizer System** P. 124

Continued

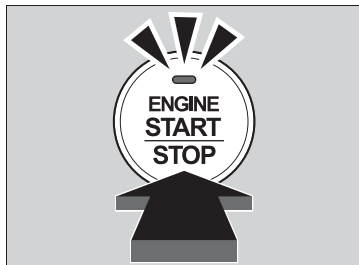

All models

3. Press the **ENGINE START/STOP** button without depressing the accelerator pedal.

▶▶ Starting the Engine

Bring the smart entry remote close to the **ENGINE START/STOP** button if the battery in the smart entry remote is weak.

- ▶ **If the Smart Entry Remote Battery is Weak**
P. 550

The engine may not start if the smart entry remote is subjected to strong radio waves.

Do not hold the **ENGINE START/STOP** button to start the engine.
If the engine does not start, wait at least 10 seconds before trying again.

مداد خودرو فارما

تلفن شبانه روزی: ۰۲۱-۸۸۸۶۲۰۸۵

FarmaSOS.com

Stopping the Engine

You can turn the engine off when the vehicle is completely stopped.

Automatic transmission/CVT models

1. Shift to **P**.
2. Press the **ENGINE START/STOP** button.

Manual transmission models

- If the shift lever is in **N**, press the **ENGINE START/STOP** button.
- If the shift lever is in any gear other than **N**, depress the clutch pedal, then press the **ENGINE START/STOP** button.

Starting to Drive

Automatic transmission/CVT models

1. Keeping your right foot on the brake pedal, release the parking brake. Check that the parking brake indicator has gone off.
 - **Parking Brake** P. 472
2. Put the shift lever in **D**. Select **R** when reversing.
3. Gradually release the brake pedal and gently depress the accelerator pedal to pull away.

■ Hill start assist system

Hill start assist keeps the brake engaged briefly to help prevent the vehicle from rolling on inclines as you move your foot from the brake pedal to the accelerator.

Manual transmission models

Depress the clutch pedal, and shift to one of the forward gears when facing uphill, or **R** when facing downhill, then release the brake pedal.

Continuously variable transmission (CVT) models

Move the shift lever to **D**, **S**, or **L** when facing uphill, or **R** when facing downhill, then release the brake pedal.

Automatic transmission models

Move the shift lever to **D** or **S** when facing uphill, or **R** when facing downhill, then release the brake pedal.

⌘ Hill start assist system

Hill start assist may not prevent the vehicle from rolling downhill on a very steep or slippery slope, and does not operate on small inclines.

Hill start assist is not a replacement for the parking brake.

Precautions While Driving

In Rain

Avoid driving in deep water and on flooded roads. This can damage the engine or driveline, or cause electrical component failure.

Other Precautions

If there is a strong impact with something under the vehicle, stop in a safe location. Check the underside of the vehicle for damage or any fluid leaks.

Precautions While Driving

NOTICE

Do not operate the shift lever while pressing the accelerator pedal. You could damage the transmission.

If the ignition switch is turned to ACCESSORY [I]*1 while driving, the engine will shut down and all steering and brake power assist functions will stop, making it difficult to control the vehicle.

Do not put the shift lever in [N], as you will lose engine braking (and acceleration) performance.

During the first 600 miles (1,000 km) of operation, avoid sudden acceleration or full throttle operation so as to not damage the engine or powertrain.

Avoid hard braking for the first 200 miles (300 km). You should also follow this when the brake pads are replaced.

NOTICE

If you repeatedly turn the steering wheel at an extremely low speed, or hold the steering wheel on the full left or right position for a while, the electric power steering (EPS) system heats up. The system goes into a protective mode, and limits its performance. The steering wheel becomes harder and harder to operate. Once the system cools down, the EPS system is restored.

Repeated operation under these conditions can eventually damage the system.

*1: Models with the smart entry system have an **ENGINE START/STOP** button instead of an ignition switch.

Automatic Transmission/CVT*

■ Creeping

The engine runs at a higher idle speed and creeping increases.
Keep the brake pedal firmly depressed when stopped.

■ Kickdown

Quickly depressing the accelerator pedal while driving uphill may cause the transmission to drop to a lower gear, unexpectedly increasing vehicle speed. Depress the accelerator pedal carefully, especially on slippery roads and curves.

امداد خودرو فارما

تلفن شبانه روزی: ۰۲۱-۸۸۸۶۲۰۸۵

FarmaSOS.com

Continuously variable transmission (CVT) models without paddle shifters

Shifting

Change the shift position in accordance with your driving needs.

■ Shift lever positions

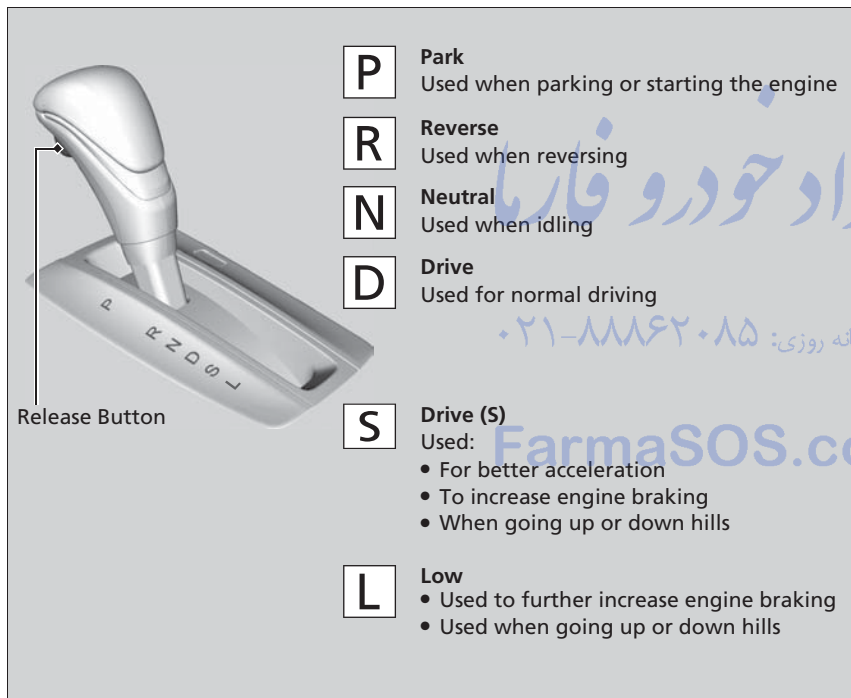

▣ Shifting

You cannot turn the ignition switch to LOCK **[0]***1 and remove the key unless the shift lever is in **[P]**.

The vehicle may move forward very slightly even in **[N]** while the engine is cold. Depress the brake pedal firmly and, when necessary, apply the parking brake.

When shifting positions in extremely low temperatures (-22°F/-30°C), there may be a short delay before the shift position is displayed. Always confirm you are in the correct shift position before driving.

*1: Models with the smart entry system have an **ENGINE START/STOP** button instead of an ignition switch.

Continued

Shift Lever Operation

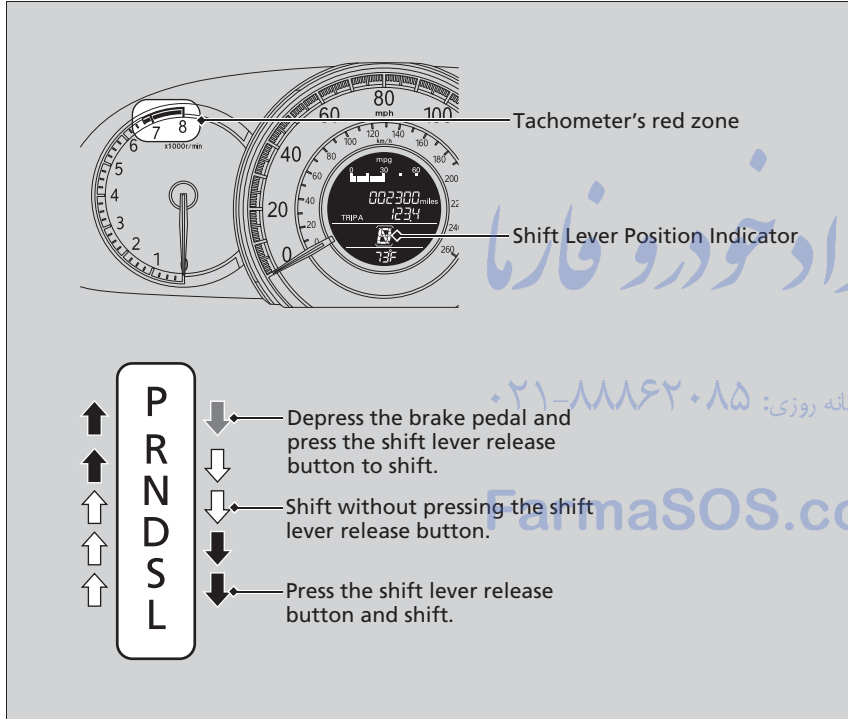

Shift Lever Operation

NOTICE

When you change the shift lever from **D** to **R** and vice versa, come to a complete stop and keep the brake pedal depressed.

Operating the shift lever before the vehicle has come to a complete standstill can damage the transmission.

Use the shift lever position indicator to check the lever position before pulling away.

If the transmission indicator blinks when driving, in any shift position, there is a problem with the transmission.

Avoid sudden acceleration and have the transmission checked by a dealer as soon as possible.

The fuel supply may be cut off if you drive at engine speeds in or over the tachometer's red zone (engine speed limit). If this happens, you may experience a slight jolt.

It may not be possible to operate the shift lever if the brake pedal is applied while the shift lever release button is held down.

Depress the brake pedal first.

Continuously variable transmission (CVT) models with paddle shifters

Shifting

Change the shift position in accordance with your driving needs.

■ Shift lever positions

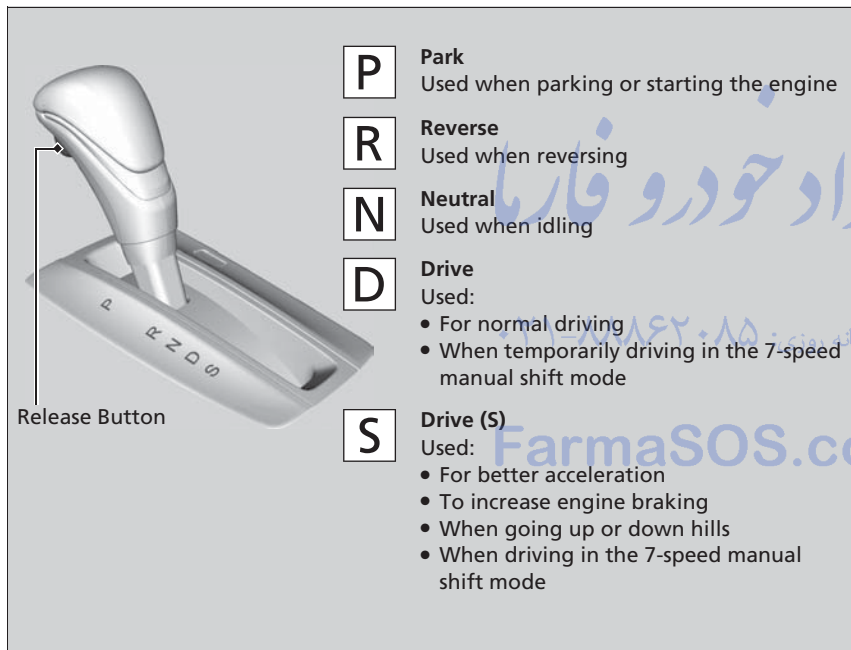

*1: Models with the smart entry system have an **ENGINE START/STOP** button instead of an ignition switch.

▶ Shifting

You cannot turn the ignition switch to LOCK **[0]***1 and remove the key unless the shift lever is in **[P]**.

The vehicle may move forward very slightly even in **[N]** while the engine is cold. Depress the brake pedal firmly and, when necessary, apply the parking brake.

When shifting positions in extremely low temperatures (-22°F/-30°C), there may be a short delay before the shift position is displayed. Always confirm you are in the correct shift position before driving.

Shift Lever Operation

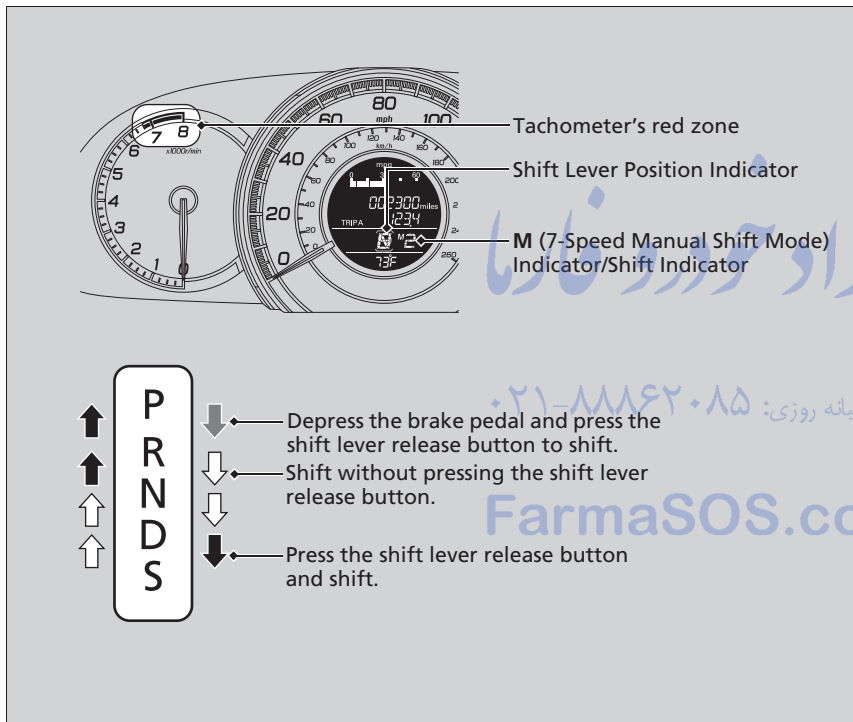

Shift Lever Operation

NOTICE

When you change the shift lever from **D** to **R** and vice versa, come to a complete stop and keep the brake pedal depressed. Operating the shift lever before the vehicle has come to a complete standstill can damage the transmission.

Use the shift lever position indicator to check the lever position before pulling away.

If the transmission indicator blinks when driving, in any shift position, there is a problem with the transmission.

Avoid sudden acceleration and have the transmission checked by a dealer as soon as possible.

The fuel supply may be cut off if you drive at engine speeds in or over the tachometer's red zone (engine speed limit). If this happens, you may experience a slight jolt.

It may not be possible to operate the shift lever if the brake pedal is applied while the shift lever release button is held down. Depress the brake pedal first.

7-Speed Manual Shift Mode

Use the paddle shifters to change between 1st and 7th speeds without removing your hands from the steering wheel. The transmission switches to the 7-speed manual shift mode when you pull a paddle shifter while driving. This mode is useful when engine braking is needed.

■ When the shift lever is in **[D]**:

The shift mode goes into the 7-speed manual shift mode temporarily, and the number is displayed in the shift indicator.

The 7-speed manual shift mode is canceled automatically if you drive at constant speed or accelerate, and the number in the shift indicator goes off.

You can cancel this mode by pulling the **[+]** paddle shifter for a few seconds.

The 7-speed manual shift mode is especially useful when reducing the vehicle speed temporarily before making a turn.

■ When the shift lever is in **[S]**:

The shift mode goes into the 7-speed manual shift mode. The **M** indicator and the speed number are displayed in the shift indicator. As the vehicle speed slows down, the transmission automatically shifts down accordingly. When the vehicle comes to a stop, it automatically shifts down into 1st.

If the vehicle speed increases and the engine speed reaches near the tachometer's red zone, the transmission automatically shifts up.

You can only pull away in 1st speed.

When canceling the 7-speed manual shift mode, move the shift lever from **[S]** to **[D]**. When the 7-speed manual shift mode is canceled, the **M** indicator and shift indicator go off.

7-Speed Manual Shift Mode

To improve fuel economy, the transmission may shift up to a higher speed than the seventh under certain circumstances. In this case, the number in the shift indicator remains as **7**.

In the 7-speed manual shift mode, the transmission shifts up or down by operating either paddle shifter under the following conditions:

Shift Up: The engine speed reaches the lowest threshold of the higher speed position.

Shift Down: The engine speed reaches the highest threshold of the lower speed position.

When the engine speed reaches near the tachometer's red zone, the transmission shifts up automatically.

When the engine speed reaches the lowest threshold of the selected speed position, the transmission shifts down automatically.

Operating the paddle shifters on slippery surfaces may cause the tires to lock up. In this case, the 7-speed manual shift mode is canceled and goes back to the normal D driving mode.

Continued

7-Speed Manual Shift Mode Operation

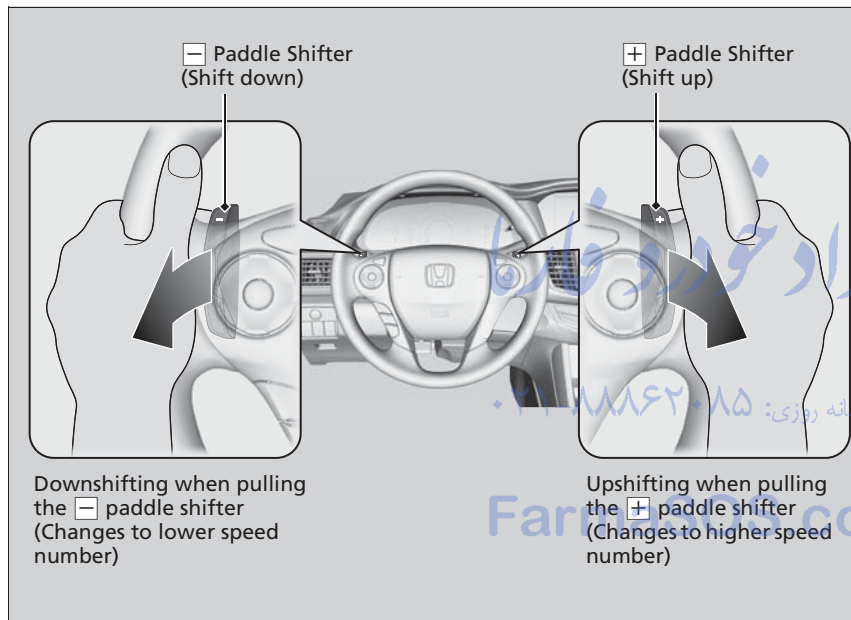

7-Speed Manual Shift Mode Operation

Each paddle shift operation makes a single speed change.

To change continuously, release the paddle shifter before pulling it again for the next speed.

Recommended Shift Points

Use this table as a guideline for efficient fuel economy and effective emission control.

Shift Up	Normal Acceleration
1 to 2	15 mph (24 km/h)
2 to 3	25 mph (40 km/h)
3 to 4	40 mph (64 km/h)
4 to 5	47 mph (76 km/h)
5 to 6	52 mph (84 km/h)
6 to 7	57 mph (92 km/h)

The shift indicator blinks when you cannot shift up or down. It indicates that your vehicle speed is not in its allowable shifting range.

Slightly accelerate to shift up and decelerate to shift down while the indicator is blinking.

Automatic transmission models

Shifting

Change the shift position in accordance with your driving needs.

■ Shift lever positions

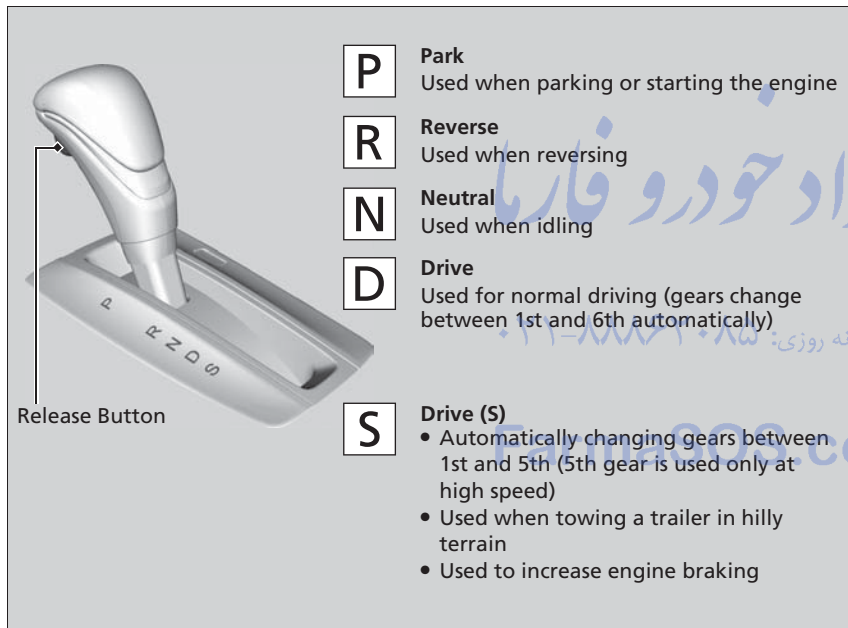

P **Park**
Used when parking or starting the engine

R **Reverse**
Used when reversing

N **Neutral**
Used when idling

D **Drive**
Used for normal driving (gears change between 1st and 6th automatically)

S **Drive (S)**

- Automatically changing gears between 1st and 5th (5th gear is used only at high speed)
- Used when towing a trailer in hilly terrain
- Used to increase engine braking

▣ Shifting

You cannot change the power mode from ON to VEHICLE OFF (LOCK) unless the shift lever is in **P**.

The vehicle may move forward very slightly even in **N** while the engine is cold. Depress the brake pedal firmly and, when necessary, apply the parking brake.

When shifting gears in extremely low temperatures (-22°F/-30°C), there may be a short delay before the shift is indicated in the display. Always confirm you are in the correct gear before driving.

Shift Lever Operation

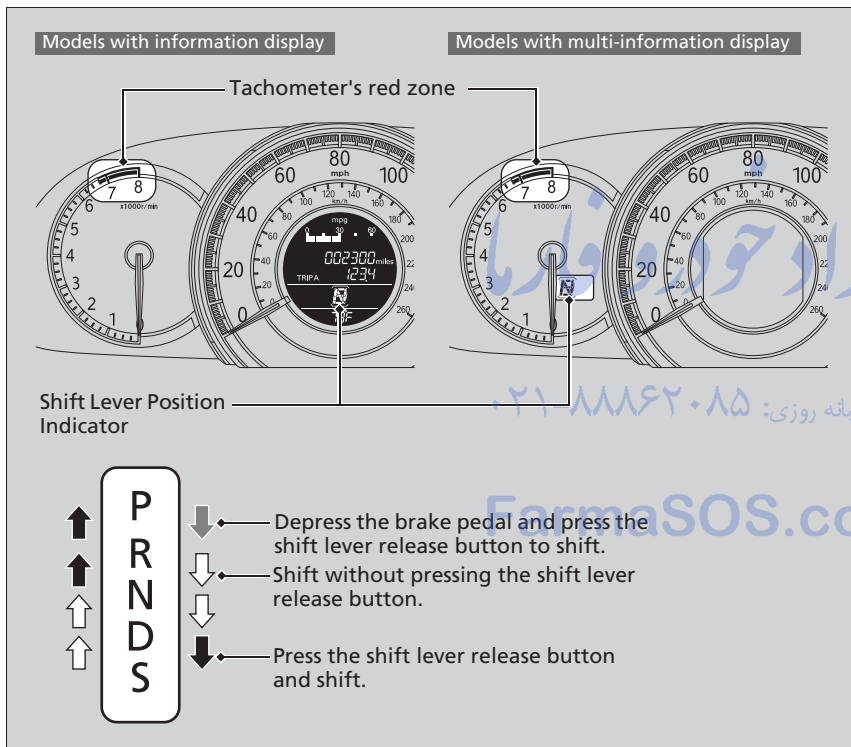

Shift Lever Operation

NOTICE

When you change the shift lever from **D** to **R** and vice versa, come to a complete stop and keep the brake pedal depressed.

Operating the shift lever before the vehicle has come to a complete standstill can damage the transmission.

Use the shift lever position indicator to check the lever position before pulling away.

If the transmission indicator blinks when driving, in any shift position, there is a problem with the transmission.

Avoid sudden acceleration and have the transmission checked by a dealer as soon as possible.

The fuel supply may be cut off if you drive at engine speeds in or over the tachometer's red zone (engine speed limit). If this happens, you may experience a slight jolt.

It may not be possible to operate the shift lever if the brake pedal is applied while the shift lever release button is held down.

Depress the brake pedal first.

Manual transmission models

Shifting

Shift Lever Operation

Fully depress the clutch pedal to operate the shift lever and change gears, then slowly release the pedal.

Depress the clutch pedal, and pause for a few seconds before shifting into **[R]**, or shift into one of the forward gears for a moment. This stops the gears so they do not “grind.”

Shifting

NOTICE

Do not shift to **[R]** before the vehicle comes to a complete stop. Shifting to **[R]** before stopping can damage the transmission.

NOTICE

Before downshifting, make sure the engine will not go into the tachometer's red zone. Should this occur, it can severely damage your engine.

There is a metallic part on the shift lever. If you leave the vehicle parked outside for a long time on a hot day, be careful before moving the shift lever. Because of heat, the shift lever may be extremely hot. If the outside temperature is low, the shift lever may feel cold.

امداد خودرو فارما

۰۲۱-۸۸۸۶۲۰۸۵: ن شبانه روزی

FarmaSOS.com

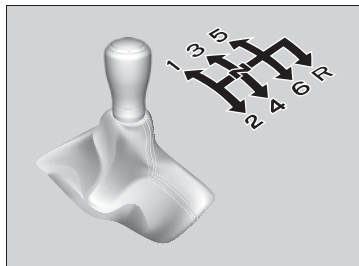

When you are not shifting, do not rest your foot on the clutch pedal. This can cause your clutch to wear out faster.

► Shifting

Recommended Shift Points

Driving in the highest gear that allows the engine to run and accelerate smoothly helps to optimize fuel economy and effective emissions control. The following shift points are recommended:

Shift Up	Normal Acceleration
1st to 2nd	17 mph (27 km/h)
2nd to 3rd	29 mph (46 km/h)
3rd to 4th	37 mph (60 km/h)
4th to 5th	43 mph (69 km/h)
5th to 6th	49 mph (79 km/h)

If you exceed the maximum speed for the gear you are in, the engine speed will enter into the tachometer's red zone. When this happens, you may experience a slight jolt.

امداد خودرو فارما

تلفن شبانه روزی: ۰۲۱-۸۸۸۶۲۰۸۵

FarmaSOS.com

Reverse Lockout

The manual transmission has a lockout mechanism that stops you from accidentally shifting into **[R]** from a forward gear while the vehicle is moving above a certain speed.

If you cannot shift to **[R]** when the vehicle is stopped, do the following:

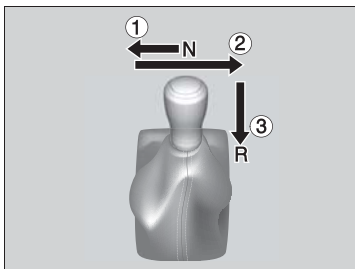

1. Depress the clutch pedal, move the shift lever all the way to the left, and shift to **[R]**.
2. If you still cannot shift into **[R]**, apply the parking brake, and turn the ignition switch to ACCESSORY **[I]** or LOCK **[O]***1.
3. Depress the clutch pedal and shift into **[R]**.
4. Keep depressing the clutch pedal and start the engine.

تلفن شبانه روزی: ۰۲۱-۸۸۸۶۲۰۸۵

Have the vehicle checked by a dealer if you have to go through this procedure repeatedly.

FarmaSOS.com

*1: Models with the smart entry system have an **ENGINE START/STOP** button instead of an ignition switch.

ECON Button

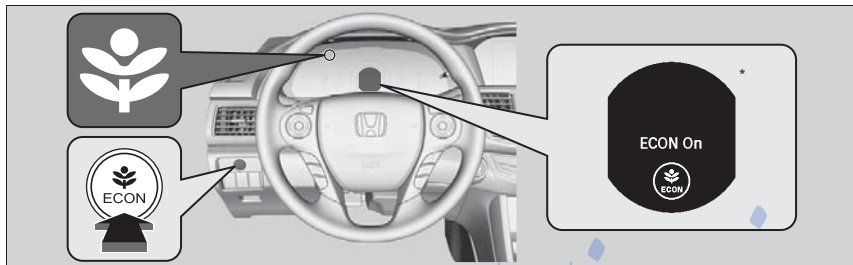

The **ECON** button turns the ECON mode on and off.

The ECON mode helps you improve your fuel economy by adjusting the performance of the engine, transmission, heating and cooling system*/climate control system*, and cruise control.

تلفن شبانه روزی: ۰۲۱-۸۸۸۶۲۰۸۵

FarmaSOS.com

Cruise Control*

Maintains a constant vehicle speed without having to keep your foot on the accelerator. Use cruise control on freeways or open roads where you can travel at a constant speed with little acceleration or deceleration.

When to use

- Vehicle speed for cruise control: Desired speed in a range above roughly 25 mph (40 km/h) ~

Automatic transmission/CVT models

- Shift positions for cruise control: In **D** or **S**

Always keep sufficient distance between you and the vehicle in front of you.



How to use

- Press the **CRUISE** button on the steering wheel.



CRUISE MAIN

CRUISE MAIN is on in the instrument panel. Cruise control is ready to use.

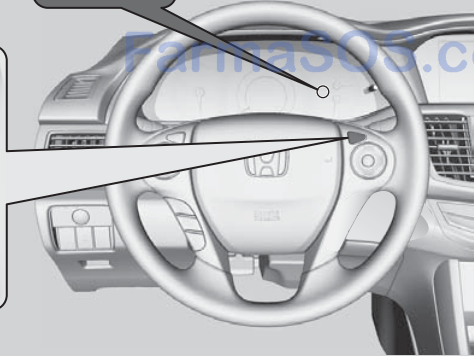

⚠ Cruise Control*

⚠ WARNING

Improper use of the cruise control can lead to a crash.

Use the cruise control only when traveling on open highways in good weather.

It may not be possible to maintain a constant speed when driving uphill or downhill.

When not using cruise control: Turn off cruise control by pressing the **CRUISE** button.

While in the ECON mode, it may take relatively more time to accelerate to maintain the set speed.

Manual transmission models

When the engine speed slows down, try to downshift.

You can maintain the set speed if you change gear within five seconds.

* Not available on all models

Continued

■ To Set the Vehicle Speed

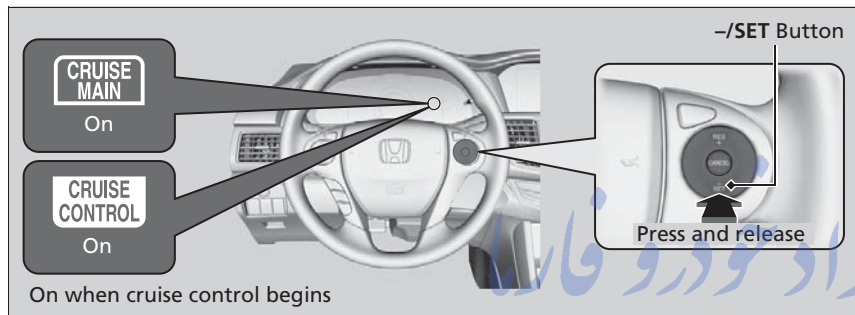

Take your foot off the pedal and press the **-/SET** button when you reach the desired speed.

The moment you release the **-/SET** button, the set speed is fixed, and cruise control begins. The **CRUISE CONTROL** indicator comes on.

تلفن شبانه روزی: ۰۲۱-۸۸۸۶۲۰۸۵

FarmaSOS.com

■ To Adjust the Vehicle Speed

Increase or decrease the vehicle speed using the **RES/+** or **-/SET** buttons on the steering wheel.

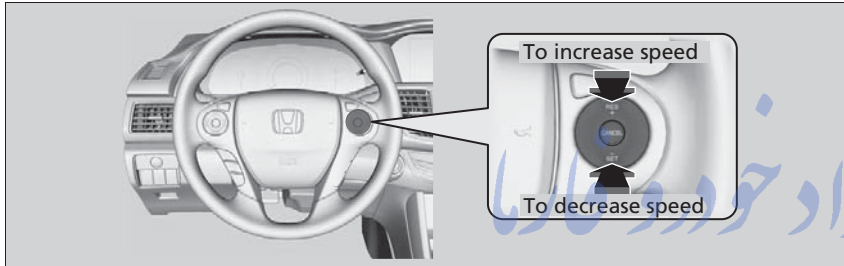

- Each time you press the button, the vehicle speed is increased or decreased by about 1 mph (1.6 km/h).
- If you keep the button pressed, the vehicle speed increases or decreases until you release it. This speed is then set.

☒ To Adjust the Vehicle Speed

You can set the vehicle speed using the **-/SET** button on the steering wheel when adjusting the speed with the accelerator and brake pedals.

☒ To Cancel

Resuming the prior set speed:
After cruise control has been canceled, you can still resume the prior set speed by pressing the **RES/+** button while driving at a speed of at least 25 mph (40 km/h) or more.

You cannot set or resume in the following situations:

- When vehicle speed is less than 25 mph (40 km/h)
- When the **CRUISE** button is turned off

At vehicle speeds of 22 mph (35 km/h) or less, cruise control is canceled automatically.

■ To Cancel

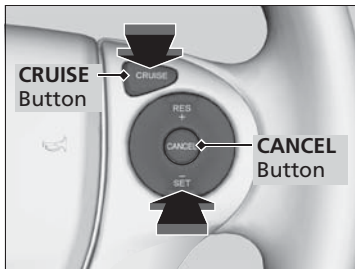

To cancel cruise control, do any of the following:

- Press the **CANCEL** button.
- Press the **CRUISE** button.
- Depress the brake pedal.
- Depress the clutch pedal for five seconds or more.

The **CRUISE CONTROL** indicator goes off.

Adaptive Cruise Control (ACC)*

Helps maintain a constant vehicle speed and a set following distance behind a vehicle detected ahead of yours, without you having to keep your foot on the brake or the accelerator.

When to use

- Vehicle speed for adaptive cruise control:
Desired speed in a range above roughly 25 mph (40 km/h) ~
- Shift positions for adaptive cruise control:
In **D** or **S**



The radar sensor is inside the front grille on the right side.

How to use

- Press the **MAIN** button on the steering wheel.

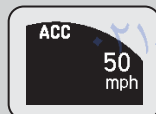

ACC is on in the multi-information display. Adaptive cruise control is ready to use.

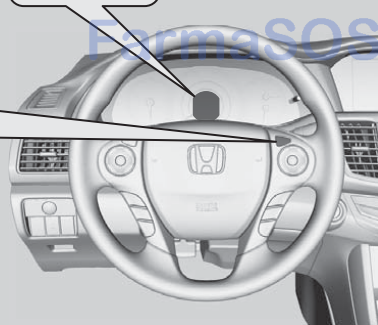

▶ Adaptive Cruise Control (ACC)*

WARNING

Improper use of ACC can lead to a crash.

Use ACC only when traveling on open highways in good weather.

WARNING

ACC has limited braking capability.

When your vehicle speed drops below 22 mph, ACC will automatically cancel and no longer will apply your vehicle's brakes.

Always be prepared to apply the brake pedal when conditions require.

Important Reminder

As with any system, there are limits to ACC. Use the brake pedal whenever necessary, and always keep a safe distance between your vehicle and other vehicles.

The radar sensor for ACC is shared with FCW (Forward Collision Warning).

▶ **Forward Collision Warning (FCW)*** P. 456

■ To Set the Vehicle Speed

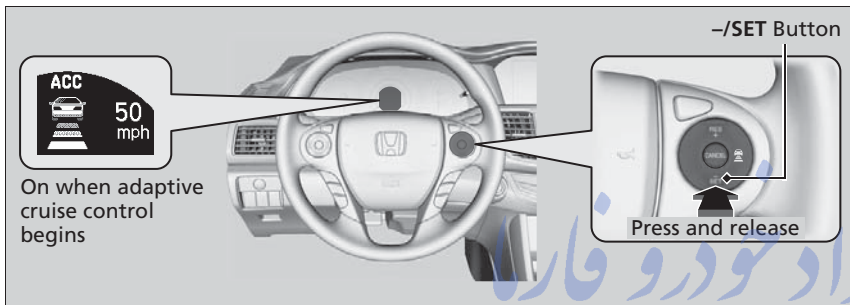

Take your foot off the pedal and press the **-/SET** button when you reach the desired speed.

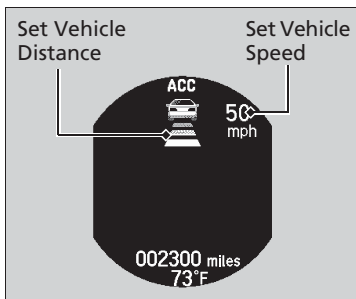

The moment you release the **-/SET** button, the set speed is fixed, and adaptive cruise control begins.

- ▶ A vehicle icon and distance bars appear on the multi-information display.

▶ Adaptive Cruise Control (ACC)*

Do not use ACC under these conditions:

- In poor visibility.
- In heavy traffic.
- When you must slow down and speed up repeatedly.
- On winding roads.
- When you enter a toll gate, interchange, service area, parking area, etc. In these areas, there is no vehicle ahead of you, but ACC would still try to accelerate to your set speed.
- In bad weather (rain, fog, snow, etc.).
- On a slippery road (for example a road covered with ice or snow).
- When a spare tire is installed.
- When going down a steep hill where the engine braking does not work sufficiently.

When not using adaptive cruise control: Turn off adaptive cruise by pressing the **MAIN** button.

▶ To Set the Vehicle Speed

You can switch the displayed set speed measurements on the multi-information display between mph and km/h.

- ▶ **Customized Features** P. 97, 298

* Not available on all models

When in Operation

The radar sensor monitors the distance between your vehicle and a vehicle ahead of you. When the sensor detects a change in distance, the system responds by accelerating or braking your vehicle in order to maintain the set speed and following distance as necessary.

■ When ACC detects a vehicle within ACC range:
The beeper sounds once and the vehicle icon appears on the multi-information display.



■ When the vehicle goes out of ACC range:
The beeper sounds **once** and the vehicle icon on the multi-information display becomes a dotted-line contour.







ACC Range: 328 ft. (100 m)

When in Operation

If the vehicle ahead of you slows down abruptly, or if another vehicle cuts in front of you, the beeper sounds and a message appears on the multi-information display to alert you to brake.

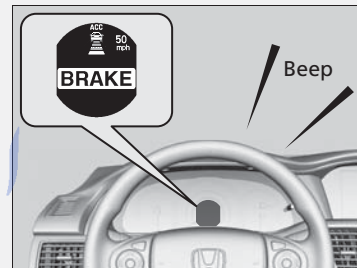

Depress the brake pedal, and keep an appropriate distance from the vehicle ahead.

Even if the distance between your vehicle and the vehicle ahead is short, FCW may not alert you or ACC may start accelerating your vehicle under the following circumstances:

- The vehicle ahead of you is going at almost the same speed as, or faster than your vehicle.
- A vehicle cuts in front of you is going faster than your vehicle, gradually distancing itself from you.

If you do not want to hear a beep when the system detects a vehicle, or when the vehicle goes out of ACC range, you can change the pre-running detect car beep setting.

➤ **Customized Features** P. 97, 298

■ There is no vehicle ahead

Your vehicle cruises at the set speed.

■ A vehicle ahead is within ACC range and going slower than the set speed

Your vehicle slows down, and maintains the same speed as the speed of the vehicle ahead to maintain the set following distance.

■ A vehicle ahead is within ACC range and going at a steady speed

Your vehicle follows the vehicle ahead of it, keeping a constant distance, without going beyond the set speed.

■ A vehicle ahead goes out of range

ACC accelerates your vehicle to the set speed, and then maintains it.

■ When you depress the accelerator pedal

You can temporarily increase the vehicle speed. In this case, there is no audible or visual alerts even if a vehicle is in ACC range.

ACC stays on unless you cancel it. Once you release the accelerator pedal, the system resumes the set speed.

☒ When in Operation**Limitations**

Be aware that ACC has limitations. For example, it is not designed to operate when a vehicle ahead of yours is going slower than 13 mph (20 km/h) or is parked. Smaller vehicles, such as motorcycles, may also be difficult for the system to detect depending on their size.

You must always be prepared to use the brake pedal to maintain a safe distance with other vehicles.

ACC may momentarily apply brakes or sound an alert if there is a vehicle or building adjacent to your vehicle and:

- You make a sudden turn or are driving on a narrow road.
- You abruptly move the steering wheel.
- Your vehicle is unusually positioned within your lane (e.g., at a slight diagonal to the lane direction).

■ To Adjust the Vehicle Speed

Increase or decrease the vehicle speed using the **RES/+** or **-/SET** buttons on the steering wheel.

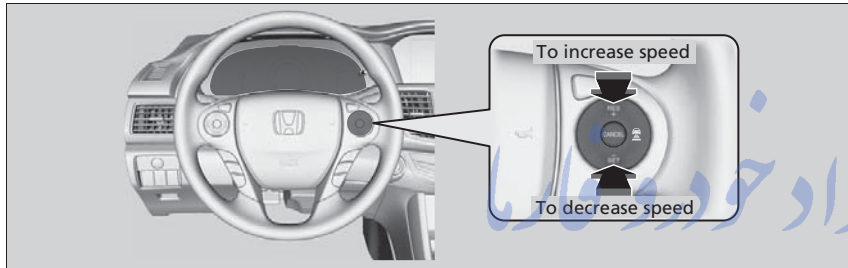

- Each time you press the button, the vehicle speed is increased or decreased by about 1 mph or 1 km/h accordingly.
- If you keep the button pressed, the vehicle speed increases or decreases by about 5 mph or 5 km/h accordingly.

■ To Change Vehicle Distance

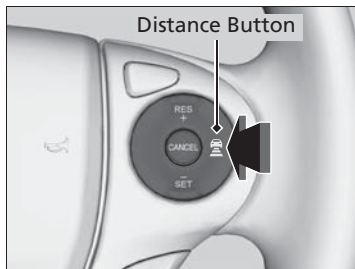

Press the  (distance) button to change ACC range.

Each time you press the button, the following distance (the distance behind a vehicle detected ahead of you) setting cycles through short, middle, long, and extra long following distances.





▶▶ To Adjust the Vehicle Speed

If a vehicle ahead is going at a speed slower than your increased set speed, ACC may not accelerate your vehicle. This is to maintain the set following distance between your vehicle and the vehicle ahead.

You can set the vehicle speed using the **-/SET** button on the steering wheel when adjusting the speed with the accelerator and brake pedals.

Determine the most appropriate following distance setting based on your specific driving conditions. Be sure to adhere to any following distance requirements set by local regulation.

The higher your selected set speed is, the greater the short, middle, long or extra long following distance becomes. See the following examples for your reference.

Vehicle Distance		When the Set Speed is:	
		50 mph (80 km/h)	65 mph (104 km/h)
Short		84 feet 26 meters 1.1 sec	102 feet 31 meters 1.1 sec
Middle		111 feet 34 meters 1.5 sec	139 feet 43 meters 1.5 sec
Long		155 feet 48 meters 2.1 sec	202 feet 62 meters 2.1 sec
Extra Long		215 feet 66 meters 3.0 sec	285 feet 87 meters 3.0 sec

امداد خودرو فارما
تلفن شبانه روزی: ۰۲۱-۸۸۶۲۸۸۵
FarmaS.com

To Cancel

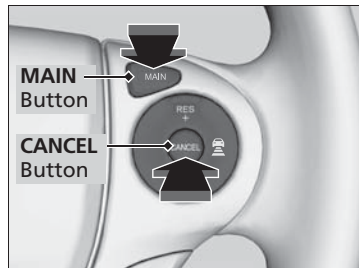

To cancel adaptive cruise control, do any of the following:

- Press the **CANCEL** button.
- Press the **MAIN** button.
- ▶ **ACC Off** appears on the multi-information display.
- Depress the brake pedal.

Automatic cancellation

The beeper sounds and a message appears on the multi-information display when ACC is automatically canceled. Any of these conditions may cause the ACC cancellation:

- Your vehicle speed slows down to 22 mph (35 km/h) and below.
- Bad weather (rain, fog, snow, etc.).
- When the radar sensor inside the front grille gets dirty.
- The vehicle ahead of you cannot be detected.
- An abnormal tire condition is detected, or the tires are skidding.
- Driving on a mountainous road, or driving off road for extended periods.
- Abrupt steering wheel movement.
- When the ABS or VSA is activated.
- When the **ABS** or VSA indicator comes on.

To Cancel

Resuming the prior set speed: After you have canceled adaptive cruise control, you can resume the prior set speed while it is still displayed. Press the **RES/+** button when driving at a speed of at least 25 mph (40 km/h) or more.

You cannot set or resume in the following situations:

- When vehicle speed is less than 25 mph (40 km/h).
- When the **MAIN** button is turned off.

Automatic cancellation



Even though adaptive cruise control has been automatically canceled, you can still resume the prior set speed. Wait until the condition that caused ACC to cancel improves, then press the **RES/+** button.

■ To Switch ACC to Cruise Control

Press and hold the  (distance) button for one second.

Cruise Mode Selected appears on the multi-information display for two seconds, and then the mode switches to **Cruise**.

To switch back to **ACC**, press and hold the  button again for one second.

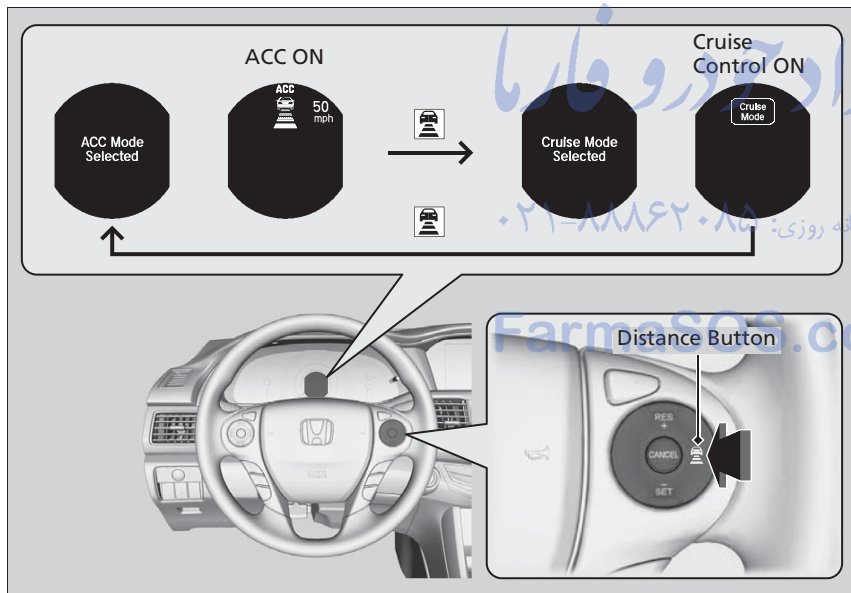

▣ To Switch ACC to Cruise Control

Always be aware which mode you are in. When you are driving in **Cruise Mode**, be more cautious about keeping a safe distance from a vehicle ahead of you.

Forward Collision Warning (FCW)*

Alerts you when it determines that there is a possibility that your vehicle may collide with a vehicle detected in front of yours.

If the system determines a collision is possible, it gives both visual and audible alerts, including a head-up warning that flashes on the windshield.

- ▶ Take appropriate action to prevent a collision (apply the brakes, change lanes, etc.).

■ How the system works

The system may give warnings of potential collisions when your vehicle speed is above 10 mph (15 km/h).

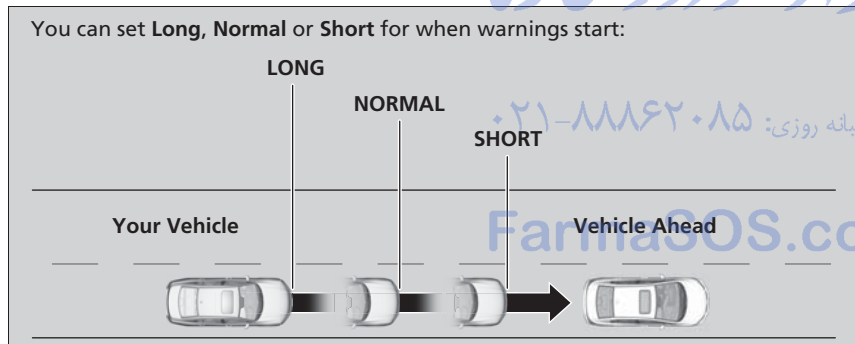

▶ Forward Collision Warning (FCW)*

Important Safety Reminder

FCW cannot detect all objects ahead and may not detect a given object; accuracy of the system will vary based on weather, speed and other factors. FCW does not include a braking function. It is always your responsibility to safely operate the vehicle and avoid collisions.

You can change the Forward Collision Warning Distance setting or turn the system on and off.

▶ **Customized Features** P. 97, 298

For the FCW system to work properly:

Models with multi-information display

- Always keep the radar sensor cover clean.
- Never use chemical solvents or polishing compounds to clean the sensor cover. Instead, clean it with water and a mild detergent.
- Do not put anything on the radar sensor cover. See a dealer if the radar sensor gets damaged or requires repair.

Models with information display

The camera is shared with Lane Departure Warning (LDW).

▶ **LDW Camera** P. 461

Models with multi-information display

Radar-based system

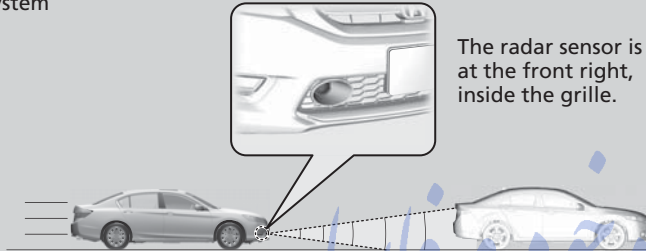

When your setting is:

Long: The head-up warning lights flash twice at **Long** distance.

When the **Short** distance is reached, the lights flash and the beeper sounds continuously until a possible collision is avoided.

Normal: The head-up warning lights flash twice at the **Normal** distance.

When the **Short** distance is reached, the lights flash and the beeper sounds continuously until a possible collision is avoided.

Short: The head-up warning lights flash and the beeper sounds continuously until a possible collision is avoided.

Head-up Warning Lights

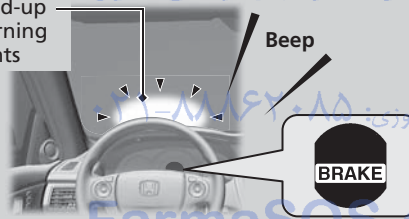

When the lights flash at any setting:
The **BRAKE** message appears until a possible collision is avoided.

▶▶ Forward Collision Warning (FCW)*

Models with information display

Never apply a film or attach any objects to the windshield that could obstruct the FCW camera's field of vision.

Scratches, nicks, and other damage to the windshield within the FCW camera's field of vision can cause the system to operate abnormally. If this occurs, we recommend that you replace the windshield with a genuine Honda replacement windshield. Making even minor repairs within the camera's field of vision or installing an aftermarket replacement windshield may also cause the system to operate abnormally. After replacing the windshield, have a dealer recalibrate the camera. Proper calibration of the FCW camera is necessary for the system to operate properly.

▶▶ How the system works

The head-up warning uses a lens located at the front end of the dashboard.

Do not cover the lens or spill any liquid on it.

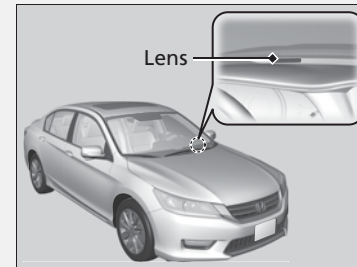

* Not available on all models

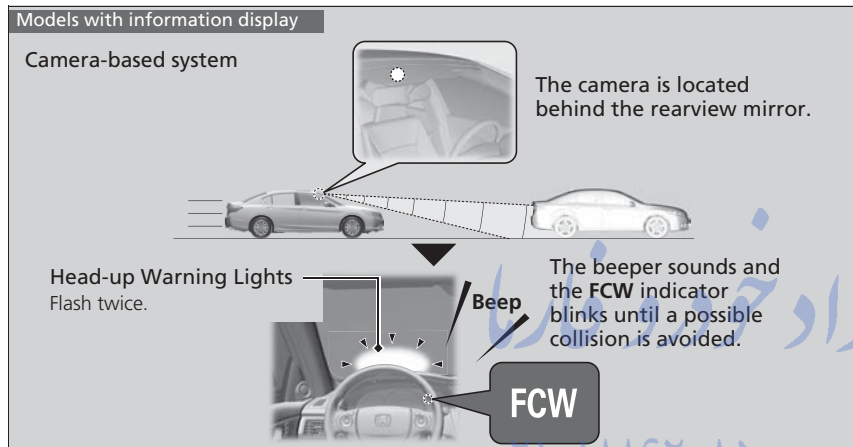

■ Automatic shutoff

FCW may automatically shut itself off and the **FCW** indicator comes and stays on when:

Models with information display

- The temperature inside the system is high.
- The windshield is blocked by dirt, mud, leaves, wet snow, etc.

Models with multi-information display

- You drive off-road or on a mountain road, or curved and winding road for an extended period.
- You drive in bad weather (rain, fog, snow, etc.).
- The radar sensor cover is blocked by dirt, mud, leaves, wet snow, etc.
- An abnormal tire condition is detected (wrong tire size, flat tire, etc.).

All models

Once the conditions that caused FCW to shut off improve or are addressed (e.g., cleaning), the system comes back on.

►► Automatic shutoff

Models with information display

To help reduce the likelihood that high interior temperatures will cause the camera system to shut off, when parking, find a shady area or face the front of the vehicle away from the sun. If you use a reflective sun shade, do not allow it to cover the camera housing. Covering the camera can concentrate heat on the camera.

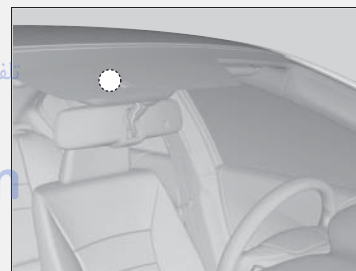

If the **CAMERA HOT** message appears:

- Use the climate control system to cool down the interior and, if necessary, the defroster mode when windows are fogged.
- Start driving the vehicle to lower the windshield temperature, which cools down the area around the FCW system.

FCW Limitations

FCW may not activate or may not detect a vehicle in front of your vehicle, and may activate even when you are aware of a vehicle ahead of you, or when there is no vehicle ahead under the following conditions.

Condition	Models with multi-information display	Models with information display
<ul style="list-style-type: none"> • The distance between your vehicle and the vehicle ahead of you is too short. • A vehicle cuts in front of you at a slow speed, and it brakes suddenly. • A vehicle suddenly crosses in front of you. • When either your vehicle or the vehicle ahead of you accelerates rapidly. • The vehicle ahead of you is a motorcycle, a small vehicle, or a unique vehicle such as a tractor. • When you drive off-road or on a mountain road, or curved and winding road for an extended period that makes it difficult for the sensor/camera to properly detect a vehicle in front of you. • When there are pedestrians or animals in front of your vehicle. • When you drive in bad weather (rain, fog, etc.). • A heavy load in the rear or modifications to the suspension tilts your vehicle. • An abnormal tire condition is detected (wrong tire size, flat tire, etc.). 	✓	✓
<ul style="list-style-type: none"> • When the windshield is blocked by dirt, mud, leaves, wet snow, etc. • When the temperature inside the system is high. • A sudden change between light and dark such as an entrance or exit of a tunnel. • You drive into the sunlight (e.g. at dawn or dusk). • When the windshield is dirty or cloudy. • When streetlights are perceived as the taillight of a vehicle in front of yours. • When driving at night, the vehicle ahead of you is running with either taillight bulb burned out. • When you drive in the shadows of trees, buildings, etc. • When your vehicle is towing a trailer. 	—	✓
<ul style="list-style-type: none"> • When the radar sensor cover is blocked by dirt, mud, leaves, wet snow, etc. • You drive under a low or narrow bridge at high speed. • You drive over speed bumps, steel road plates, etc., or your vehicle approaches train tracks or roadside objects (such as a traffic sign and guard rail) on a curve. 	✓	—

Lane Departure Warning (LDW)*

Alerts you when the system detects a possibility of your vehicle unintentionally crossing over detected side lane markings.

How the System Works

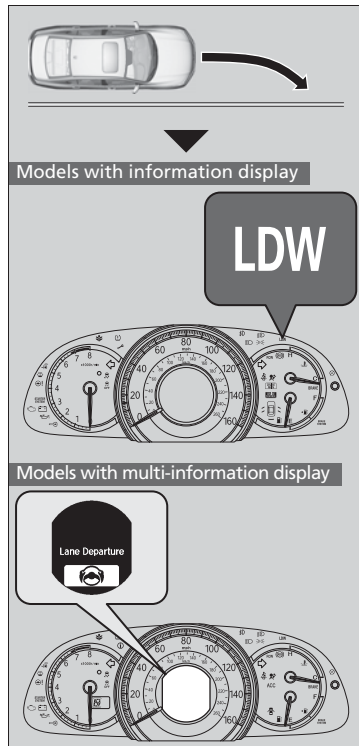

If your vehicle is getting too close to detected left or right side lane markings without a turn signal activated, LDW will give audible and visual alerts.

Models with information display

The beeper sounds and the **LDW** indicator blinks, letting you know that you need to take appropriate action.

Models with multi-information display

The beeper sounds and the **Lane Departure** message appears on the multi-information display, letting you know that you need to take appropriate action.

▶ Lane Departure Warning (LDW)*

Important Safety Reminder

Like all assistance systems, LDW has limitations. Over-reliance on LDW may result in a collision. It is always your responsibility to keep the vehicle within your driving lane.

LDW only alerts you when lane drift is detected without a turn signal in use. LDW may not detect all lane markings or lane departures; accuracy will vary based on weather, speed and lane marker condition. It is always your responsibility to safely operate the vehicle and avoid collisions.

تلفن شبانه روزی: ۰۲۱-۸۸۸۶۲۰۸۵

FarmaSOS.com

How the System Activates

The system begins to search for lane markings when all the following conditions are met:

- The vehicle is traveling between 40-90 mph (64-145 km/h).
- The vehicle is on a straight or slightly curved road.
- The turn signals are off.
- The brake pedal is not depressed.

LDW Camera

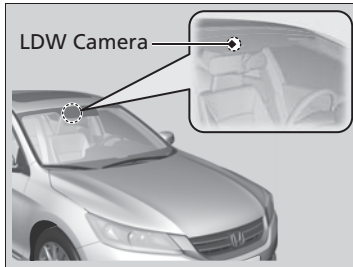

The camera is located behind the rearview mirror.

How the System Activates

LDW may automatically shut off and the **LDW** indicator comes and stays on.

➤ **Indicators** P. 79

LDW Camera

Never apply a film or attach any objects to the windshield that could obstruct the LDW camera's field of vision.

Scratches, nicks, and other damage to the windshield within the LDW camera's field of vision can cause the system to operate abnormally. If this occurs, we recommend that you replace the windshield with a genuine Honda replacement windshield. Making even minor repairs within the camera's field of vision or installing an aftermarket replacement windshield may also cause the system to operate abnormally. After replacing the windshield, have a dealer recalibrate the camera. Proper calibration of the LDW camera is necessary for the system to operate properly.

Do not place an object on the top of the instrument panel. It may reflect onto the windshield and prevent the system from detecting lane lines properly.

Continued

LDW On and Off

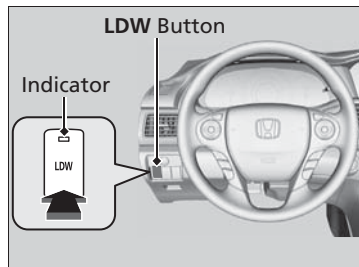

Press the **LDW** button to turn the system on and off.

- ▶ The indicator in the button comes on when the system is on.

LDW Camera

To help reduce the likelihood that high interior temperatures will cause the camera system to shut off, when parking, find a shady area or face the front of the vehicle away from the sun. If you use a reflective sun shade, do not allow it to cover the camera housing. Covering the camera can concentrate heat on the camera.

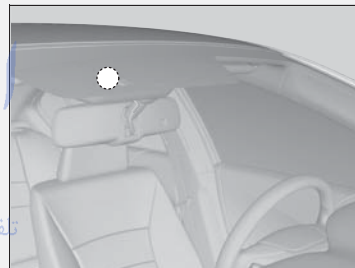

If the **CAMERA HOT** message appears:

- Use the climate control system to cool down the interior and, if necessary, the defroster mode when windows are fogged.
- Start driving the vehicle to lower the windshield temperature, which cools down the area around the LDW camera.

امداد خودرو فارما

تلفن شبانه روزی: ۰۲۱-۸۸۸۶۲۰۸۵

FarmaSOS.com

LDW Limitations

LDW may not activate or may not recognize lanes, and may activate even when keeping in the middle of a lane under the following conditions.

Condition

- When you drive in bad weather (rain, fog, etc.).
- A heavy load in the rear or modifications to the suspension tilts your vehicle.
- An abnormal tire condition is detected (wrong tire size, flat tire, etc.).
- When the windshield is blocked by dirt, mud, leaves, wet snow, etc.
- When the temperature inside the system is high.
- A sudden change between light and dark such as an entrance or exit of a tunnel.
- You drive into the sunlight (e.g. at dawn or dusk).
- When the windshield is dirty or cloudy.
- When you drive in the shadows of trees, buildings, etc.
- When your vehicle is towing a trailer.
- When you drive on a wet road surface following another vehicle.
 - ▶ The camera may perceive the tire tracks in the water as lane lines.
- When there is snow or wheel tracks on the side of the road.
- When the road has many repaired areas or erased lines.
- When the vehicle is running over painted signs or crosswalk markings.
- When you drive in a lane with worn-out lane markings.

Vehicle Stability Assist (VSA®), aka Electronic Stability Control (ESC), System

Helps to stabilize the vehicle during cornering if the vehicle turns more or less than what was intended. It also assists in maintaining traction on slippery surfaces. It does so by regulating engine output and selectively applying the brakes.

■ VSA® Operation

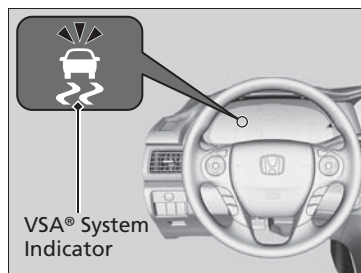

When VSA® activates, you may notice that the engine does not respond to the accelerator. You may also notice some noise from the hydraulic system. You will also see the indicator blink.

▣ Vehicle Stability Assist (VSA®), aka Electronic Stability Control (ESC), System

VSA® may not function properly if tire type and size are mixed. Make sure to use the same size and type of tire, and the air pressures as specified.

When the VSA® indicator comes on and stays on while driving, there may be a problem with the system. While this may not interfere with normal driving, have your vehicle checked by a dealer immediately.

VSA® cannot enhance stability in all driving situations and does not control the entire braking system. You still need to drive and corner at speeds appropriate for the conditions and always leave a sufficient margin of safety.

The main function of the VSA® system is generally known as Electronic Stability Control (ESC). The system also includes a traction control function.

VSA® On and Off

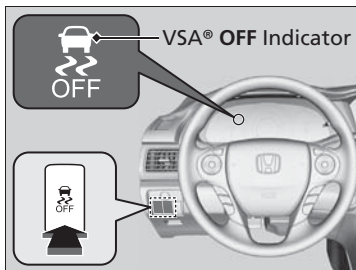

This button is on the driver side control panel. To turn the VSA® system on and off, press and hold it until you hear a beep.

VSA® will stop and the indicator will come on.

To turn it on again, press the  (VSA® OFF) button until you hear a beep.

VSA® is turned on every time you start the engine, even if you turned it off the last time you drove the vehicle.

Vehicle Stability Assist (VSA®), aka Electronic Stability Control (ESC), System

Without VSA®, your vehicle will have normal braking and cornering ability, but it will not have VSA® traction and stability enhancement.

In certain unusual conditions when your vehicle gets stuck in shallow mud or fresh snow, it may be easier to free it with the VSA® temporarily switched off.

When the VSA® system is off, the traction control system is also off. You should only attempt to free your vehicle with the VSA® off if you are not able to free it when the VSA® is on.

Immediately after freeing your vehicle, be sure to switch VSA® on again. We do not recommend driving your vehicle with the VSA® and traction control systems switched off.

If the low tire pressure/TPMS indicator comes on or blinks, the VSA® system comes on automatically. In this case, you cannot turn the system off by pressing the  button.

You may hear a motor sound coming from the engine compartment while system checks are being performed immediately after starting the engine or while driving. This is normal.

شماره شبانه روزی: ۰۲۱-۸۸۸۶۲۰۸۵

FarmaSOS.com

LaneWatch™*

Is an assistance system that allows you to check the passenger side rear areas displayed on the audio/information screen when the turn signal is activated to the passenger's side. A camera in the passenger side door mirror monitors these areas and allows you to check for vehicles, in addition to your visual check and use of the passenger door mirror. You can also keep the system on for your convenience while driving.

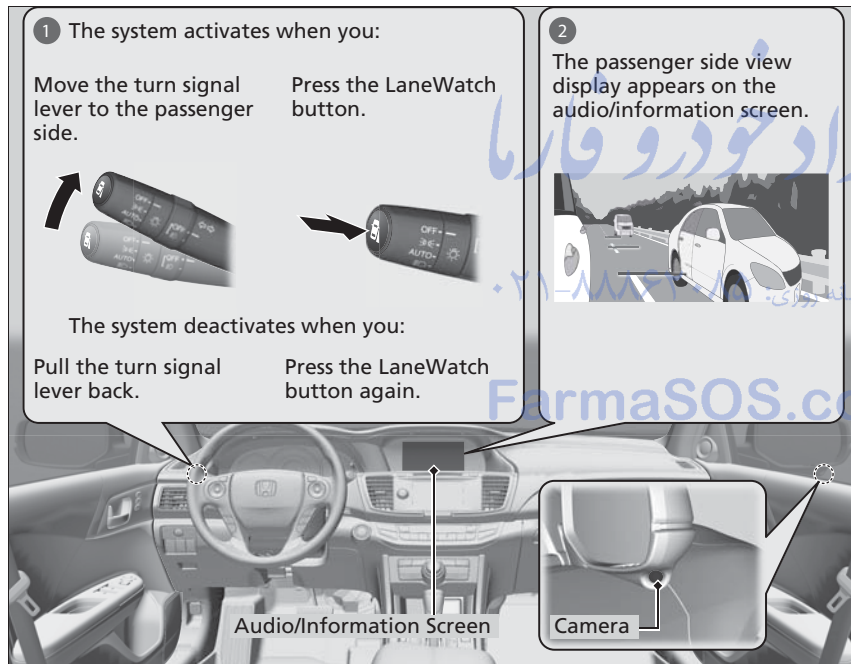

▶ LaneWatch™*

⚠ WARNING

Failure to visually confirm that it is safe to change lanes before doing so may result in a crash and serious injury or death.

Do not rely only on LaneWatch while driving.

Always look in your mirrors, to either side of your vehicle, and behind you for other vehicles before changing lanes.

Important Safety Reminder

Like all assistance systems, LaneWatch has limitations. Over reliance on LaneWatch may result in a collision.

The LaneWatch function can be affected by weather, lighting (including headlights and low sun angle), ambient darkness, camera condition, and loading.

The LaneWatch may not provide the intended display of traffic to the side and rear under the following conditions:

- Your vehicle's suspension has been altered, changing the height of the vehicle.
- Your tires are over or under inflated.
- Your tires or wheels are of varied size or construction.

■ Customizing the LaneWatch settings

You can customize the following items using the audio/information screen.

- **Show with Turn Signal:** Selects whether LaneWatch monitor comes on when you operate the turn signal light lever.
- **Reference Lines:** Selects whether the reference lines appear on the LaneWatch monitor.
- **Next Maneuver Pop up*:** Selects whether a turn direction screen of the navigation system interrupts the LaneWatch display.
- **Display:** Adjusts display settings.
 - ☑ **Customized Features** P. 298

■ Reference Lines

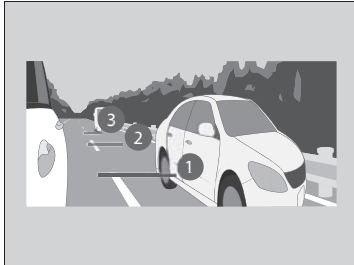

Three lines that appear on the screen can give an idea of how far the vehicles or objects on the screen are from your vehicle, respectively. If an object is near line 1 (in red), it indicates that it is close to your vehicle whereas an object near line 3 farther away.

☒ LaneWatch™*

The LaneWatch camera view is restricted. Its unique lens makes objects on the screen look slightly different from what they are.

LaneWatch display does not come on when the shift lever is in [R].

For proper LaneWatch operation:

- The camera is located in the passenger side door mirror. Always keep this area clean. If the camera lens is covered with dirt or moisture, use a soft, moist cloth to keep the lens clean and free of debris.
- Do not cover the camera lens with labels or stickers of any kind.
- Do not touch the camera lens.

☒ Reference Lines

The area around the reference line 1 (red) is very close to your vehicle. As always, make sure to visually confirm the safety of a lane change before changing lanes.

The distance between your vehicle and lines 1, 2 and 3 on the screen vary depending on road conditions and vehicle loading. For example, the reference lines on the screen may seem to appear closer than the actual distances when the rear of your vehicle is more heavily loaded.

Consult a dealer if:

- The passenger side door mirror, or area around it is severely impacted, resulting in changing the camera angle.
- The LaneWatch display does not come on at all.

* Not available on all models

Tire Pressure Monitoring System (TPMS)

Instead of directly measuring the pressure in each tire, the TPMS on this vehicle monitors and compares the rolling radius and rotational characteristics of each wheel and tire while you are driving to determine if one or more tires are significantly under-inflated. This will cause the low tire pressure/TPMS indicator to come on and a message to appear on the multi-information display*.

TPMS Calibration

You must start TPMS calibration every time you:

- Adjust the pressure in one or more tires.
- Rotate the tires.
- Replace one or more tires.

Before calibrating the TPMS:

- Set the cold tire pressure in all four tires.
 ➤ **Checking Tires** P. 523

Make sure:

- The vehicle is at a complete stop.

Manual transmission models

- The shift lever is in **[N]**.

Automatic transmission/CVT models

- The shift lever is in **[P]**.

All models

- The ignition switch is in ON **[II]***1.

*1: Models with the smart entry system have an **ENGINE START/STOP** button instead of an ignition switch.

* Not available on all models

Tire Pressure Monitoring System (TPMS)

The system does not monitor the tires when driving at low speed.

Conditions such as low ambient temperature and altitude change directly affect tire pressure and can trigger the low tire pressure/TPMS indicator to come on.

Tire pressure checked and inflated in:

- Warm weather can become under-inflated in colder weather.
 - Cold weather can become over-inflated in warmer weather.
- The low tire pressure indicator will not come on as a result of over inflation.

The TPMS may not function properly if tire type and size are mixed. Make sure to use the same size and type of tire.

➤ **Checking and Maintaining Tires** P. 523

The low tire pressure/TPMS indicator may come on with a delay or may not come on at all when:

- You rapidly accelerate, decelerate, or turn the steering wheel.
- You drive on snowy or slippery roads.
- Snow chains are used.

The low tire pressure/TPMS indicator may come on under the following conditions:

- A compact spare tire is used.
- There is a heavier and uneven load on the tires, such as when towing a trailer, than the condition at calibration.
- Snow chains are used.

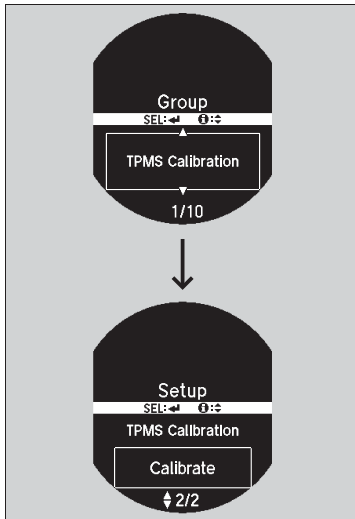
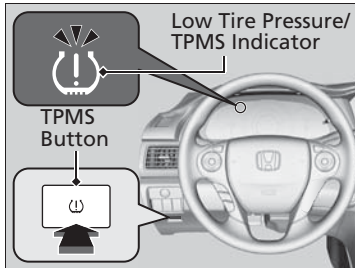

Models with information display

Press and hold the TPMS button until the low tire pressure/TPMS indicator blinks twice, indicating the calibration process has begun.

- If the low tire pressure/TPMS indicator does not blink, confirm the above conditions then press and hold the TPMS button again.
- The calibration process finishes automatically.

Models with multi-information display

You can calibrate the system from the customized features on the multi-information display.

1. Press the button to select **Vehicle Settings**, then press the **SEL/RESET** button.
 - ▶ **TPMS Calibration** appears on the display.
2. Press the **SEL/RESET** button.
 - ▶ The display switches to the customization setup screen, where you can select **Cancel** or **Calibrate**.
3. Press the button and select **Calibrate**, then press the **SEL/RESET** button.
 - ▶ **Calibration Started** screen appears, then the display returns to the customization menu screen.

- If the **Calibration Failed to Start** message appears, repeat steps 2-3.
- The calibration process finishes automatically.

TPMS Calibration

- TPMS cannot be calibrated if a compact spare tire is installed.
- The calibration process requires approximately 30 minutes of cumulative driving at speeds between 30-60 mph (48-97 km/h).
- During this period, if the ignition is turned on and the vehicle is not moved within 45 seconds, you may notice the low tire pressure indicator comes on briefly. This is normal and indicates that the calibration process is not yet complete.

You can calibrate the system using the audio/information screen.

Customized Features P. 298

If the snow chains are installed, remove them before calibrating the TPMS.

If the low tire pressure/TPMS indicator comes on even when the properly inflated specified regular tires are installed, have the vehicle checked by a dealer.

We recommend that the tires be replaced with the same brand, model, and size as the originals. Ask a dealer for details.

U.S. models

Tire Pressure Monitoring System (TPMS) - Required Federal Explanation

Each tire, including the spare (if provided), should be checked monthly when cold and inflated to the inflation pressure recommended by the vehicle manufacturer on the vehicle placard or tire inflation pressure label.

(If your vehicle has tires of a different size than the size indicated on the vehicle placard or tire inflation pressure label, you should determine the proper tire inflation pressure for those tires.)

As an added safety feature, your vehicle has been equipped with a tire pressure monitoring system (TPMS) that illuminates a low tire pressure telltale



when one or more of your tires is significantly under-inflated.

Accordingly, when the low tire pressure telltale illuminates, you should stop and check your tires as soon as possible, and inflate them to the proper pressure.

Driving on a significantly under-inflated tire causes the tire to overheat and can lead to tire failure. Under-inflation also reduces fuel efficiency and tire tread life, and may affect the vehicle's handling and stopping ability.

Please note that the TPMS is not a substitute for proper tire maintenance, and it is the driver's responsibility to maintain correct tire pressure, even if under-inflation has not reached the level to trigger illumination of the TPMS low tire pressure telltale.

Your vehicle has also been equipped with a TPMS malfunction indicator to indicate when the system is not operating properly. The TPMS malfunction indicator is combined with the low tire pressure telltale. When the system detects a malfunction, the telltale will flash for approximately one minute and then remain continuously illuminated. This sequence will continue upon subsequent vehicle start-ups as long as the malfunction exists.

When the malfunction indicator is illuminated, the system may not be able to detect or signal low tire pressure as intended.

TPMS malfunctions may occur for a variety of reasons, including the installation of replacement or alternate tires or wheels on the vehicle that prevent the TPMS from functioning properly.

Always check the TPMS malfunction telltale after replacing one or more tires or wheels on your vehicle to ensure that the replacement or alternate tires and wheels allow the TPMS to continue to function properly.

Brake System

Parking Brake

Use the parking brake to keep the vehicle stationary when parking.

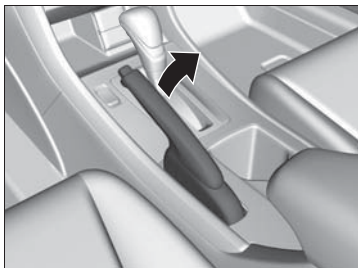

To apply:

Pull the lever fully up without pressing the release button.

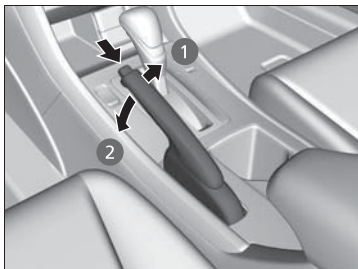

To release:

1. Pull the lever slightly, and press and hold the release button.
2. Lower the lever down all the way, then release the button.

» Parking Brake

NOTICE

Release the parking brake fully before driving. The rear brakes and axle can be damaged if you drive with the parking brake applied.

If you start driving without fully releasing the parking brake, a buzzer sounds as a warning, and **Release Parking Brake** appears on the multi-information display*.

Always apply the parking brake when parking.

■ Foot Brake

Your vehicle is equipped with disc brakes at all four wheels. A vacuum power assist helps reduce the effort needed on the brake pedal. The brake assist system increases the stopping force when you depress the brake pedal hard in an emergency situation. The anti-lock brake system (ABS) helps you retain steering control when braking very hard.

➤ **Brake Assist System** P. 475

➤ **Anti-lock Brake System (ABS)** P. 474

▣ Foot Brake

Check the brakes after driving through deep water, or if there is a buildup of road surface water. If necessary, dry the brakes by lightly depressing the pedal several times.

If you hear a continuous metallic friction sound when applying the brakes, the brake pads need to be replaced. Have your vehicle checked by a dealer.

Constantly using the brake pedal while going down a long hill builds up heat, which reduces the brake effectiveness. Apply engine braking by taking your foot off the accelerator pedal and downshifting to a lower gear. With manual transmission use a lower gear for greater engine braking.

Do not rest your foot on the brake pedal while driving, as it will lightly apply the brakes and cause them to lose effectiveness over time and reduce pad life. It will also confuse drivers behind you.

مداد خودرو فارما

تلفن شبانه روزی: ۰۲۱-۸۸۸۶۲۰۸۵

FarmaSOS.com

Anti-lock Brake System (ABS)

■ ABS

Helps prevent the wheels from locking up, and helps you retain steering control by pumping the brakes rapidly, much faster than you.

The electronic brake distribution (EBD) system, which is part of the ABS, also balances the front-to-rear braking distribution according to vehicle loading.

You should never pump the brake pedal. Let the ABS work for you by always keeping firm, steady pressure on the brake pedal. This is sometimes referred to as “stomp and steer.”

■ ABS operation

The brake pedal may pulsate slightly when the ABS is working. Keep holding the pedal firmly down. On dry pavement, you will need to press on the brake pedal very hard before the ABS activates. However, you may feel the ABS activate immediately if you are trying to stop on snow or ice.

When the vehicle speed goes under 6 mph (10 km/h), the ABS stops.

►► Anti-lock Brake System (ABS)

NOTICE

The ABS may not function correctly if you use an incorrect tire type and size.

When the **ABS** indicator comes on while driving, there may be a problem with the system.

While normal braking is not affected, there is a possibility of the ABS not operating. Have the vehicle checked by a dealer immediately.

The ABS does not reduce the time or distance it takes to stop the vehicle. It only helps with steering control during hard braking.

In the following cases, your vehicle may need more stopping distance than a vehicle without the ABS:

- When driving on rough road surfaces, including when driving on uneven surfaces, such as gravel or snow.
- When snow chains are installed.

You may hear a motor sound coming from the engine compartment while system checks are being performed immediately after starting the engine or while driving. This is normal.

Brake Assist System

■ Brake Assist System

Designed to assist the driver by generating greater braking force when you depress the brake pedal hard during emergency braking.

■ Brake assist system operation

Press the brake pedal firmly for more powerful braking.

When brake assist operates, the pedal may wiggle slightly and an operating noise may be heard. This is normal. Keep holding the brake pedal firmly down.

امداد خودرو فارما

تلفن شبانه روزی: ۰۲۱-۸۸۸۶۲۰۸۵

FarmaSOS.com

When Stopped

1. Depress the brake pedal firmly.
2. Firmly apply the parking brake.

Automatic transmission/CVT models

3. Move the shift lever from **D** to **P**.

Manual transmission models

3. Move the shift lever to **R** or **1**.

All models

4. Turn off the engine.

Always set the parking brake firmly, in particular if you are parked on an incline.

» Parking Your Vehicle

Do not park your vehicle near flammable objects, such as dry grass, oil, or timber. Heat from the exhaust can cause a fire.

» When Stopped

Automatic transmission/CVT models

NOTICE

The following can damage the transmission:

- Depressing the accelerator and brake pedals simultaneously.
- Holding the vehicle in place when facing uphill by depressing the accelerator pedal.
- Moving the shift lever into **P** before the vehicle stops completely.

Raise the wiper arms when snow is expected.

تلفن شبانه روزی: ۰۲۱-۸۸۸۶۲۰۸۵

FarmaSOS.com

Multi-View Rear Camera

Models with two displays/Models with navigation system

About Your Multi-View Rear Camera

The audio/information screen can display your vehicle's rear view. The display automatically changes to the rear view when the shift lever is moved to **[R]**.

Multi-View Rear Camera Display Area

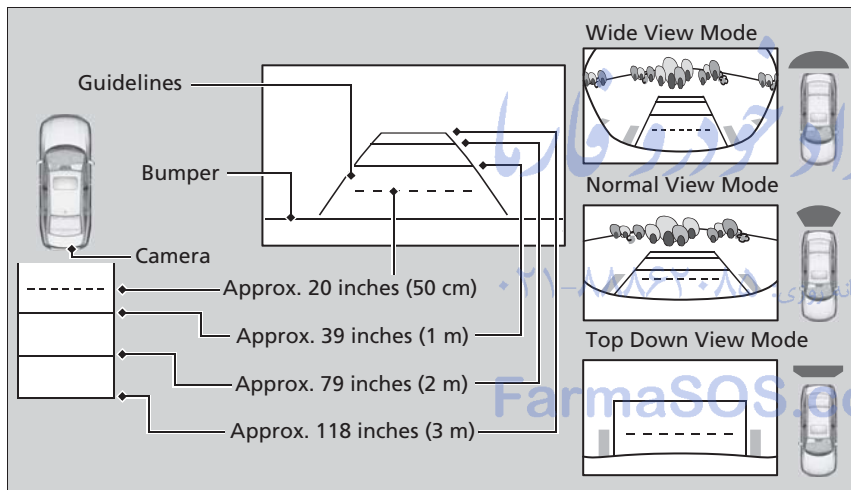

You can view three different camera angles on the rearview display. Press the selector knob or the interface dial to switch the angle.

If the last used viewing mode is Wide or Normal, the same mode is selected the next time you shift into **[R]**. If Top View was last used, Wide mode is selected.

About Your Multi-View Rear Camera

The rear camera view is restricted. You cannot see the corner ends of the bumper or what is underneath the bumper. Its unique lens also makes objects appear closer or farther than they actually are.

Visually confirm that it is safe to drive before backing up. Certain conditions (such as weather, lighting, and high temperatures) may also restrict the rear view. Do not rely on the rearview display which does not give you all information about conditions at the back of your vehicle.

If the camera lens is covered with dirt or moisture, use a soft, moist cloth to keep the lens clean and free of debris.

You can change the **Fixed Guideline** and **Dynamic Guideline** settings.

➤ **Customized Features** P. 298

Fixed Guideline

On: Guidelines appear when you shift into **[R]**.

Off: Guidelines do not appear.

Dynamic Guideline

On: Guidelines move according to the steering wheel direction.

Off: Guidelines do not move.

Models with one display

About Your Rearview Camera

The audio/information screen can display your vehicle's rear view.

The display automatically changes to a rear view when the shift lever is moved to **[R]**.

Rearview Camera Display Area

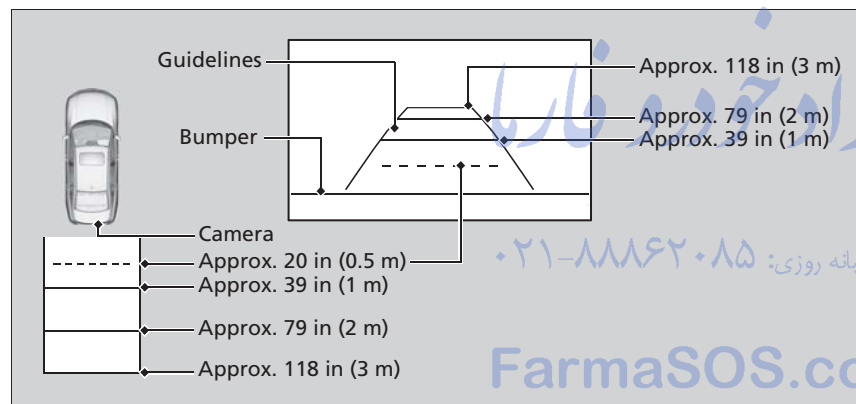

The rearview camera has a unique lens that makes objects appear closer or further than they actually are.

About Your Rearview Camera

The rear camera view is restricted. You cannot see the corner ends of the bumper or what is underneath the bumper. Its unique lens also makes objects appear closer or farther than they actually are.

Visually confirm that it is safe to drive before backing up. Certain conditions (such as weather, lighting, and high temperatures) may also restrict the rear view. Do not rely on the rearview display which does not give you all information about conditions at the back of your vehicle.

If the camera lens is covered with dirt or moisture, use a soft, moist cloth to keep the lens clean and free of debris.

You can change the **Fixed Guideline** and **Dynamic Guideline** settings.

➤ **Customized Features** P. 298

Fixed Guideline

On: Guidelines appear when you shift into **[R]**.

Off: Guidelines do not appear.

Dynamic Guideline

On: Guidelines move according to the steering wheel direction.

Off: Guidelines do not move.

Fuel Information

■ Fuel recommendation

Unleaded gasoline, pump octane number 87 or higher

Use of a lower octane gasoline can cause a persistent, heavy metallic knocking noise that can lead to engine damage.

■ Top tier detergent gasoline

Because the level of detergency and additives in gasoline vary in the market, Honda endorses the use of "TOP TIER Detergent Gasoline" where available to help maintain the performance and reliability of your vehicle. TOP TIER Detergent Gasoline meets a new gasoline standard jointly established by leading automotive manufacturers to meet the needs of today's advanced engines.

Qualifying gasoline retailers will, in most cases, identify their gasoline as having met "TOP TIER Detergent Gasoline" standards at the retail location. This fuel is guaranteed to contain the proper level of detergent additives and be free of metallic additives. The proper level of detergent additives, and absence of harmful metallic additives in gasoline, help avoid build-up of deposits in your engine and emission control system.

For further important fuel-related information for your vehicle, or on information on gasoline that does not contain MMT, visit www.hondacars.com. In Canada, visit www.honda.ca for additional information on gasoline. For more information on top tier gasoline, visit www.toptiergas.com.

■ Fuel tank capacity: 17.2 US gal (65 liters)

☞ Fuel Information

NOTICE

We recommend quality gasoline containing detergent additives that help prevent fuel system and engine deposits. In addition, in order to maintain good performance, fuel economy, and emissions control, we strongly recommend the use of gasoline that does NOT contain harmful manganese-based fuel additives such as MMT, if such gasoline is available.

Use of gasoline with these additives may adversely affect performance, and cause the malfunction indicator lamp on your instrument panel to come on. If this happens, contact a dealer for service.

Some gasoline today is blended with oxygenates such as ethanol. Your vehicle is designed to operate on oxygenated gasoline containing up to 15% ethanol by volume. Do not use gasoline containing methanol. If you notice any undesirable operating symptoms, try another service station or switch to another brand of gasoline.

How to Refuel

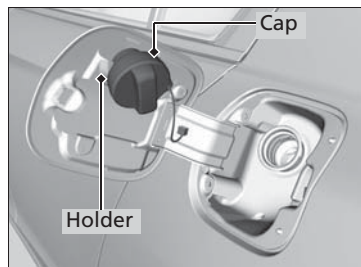
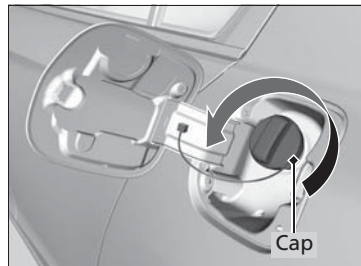
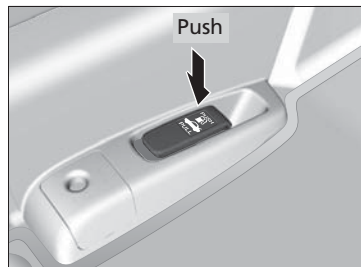

1. Stop your vehicle with the service station pump on the left side of the vehicle in the rear.
2. Turn off the engine.
3. Push on the fuel fill door release handle at the foot of the driver's seat.
 - The fuel fill door opens.
4. Remove the fuel fill cap slowly. If you hear a release of air, wait until this stops, then turn the knob slowly to open the fuel fill cap.
5. Place the fuel fill cap in the holder.
6. Insert the filler nozzle fully.
 - When the tank is full, the fuel nozzle will click off automatically. This leaves space in the fuel tank in case the fuel expands with a change in the temperature.
7. After filling, replace the fuel fill cap, tightening it until you hear it click at least once.
 - Shut the fuel fill door by hand.

How to Refuel

⚠ WARNING

Gasoline is highly flammable and explosive. You can be burned or seriously injured when handling fuel.

- Stop the engine, and keep heat, sparks, and flame away.
- Handle fuel only outdoors.
- Wipe up spills immediately.

The filler nozzle automatically stops to leave space in the fuel tank so that fuel does not overflow as a result of changes in air temperature.

If the fuel nozzle keeps turning off when the tank is not full, there may be a problem with the pump's fuel vapor recovery system. Try filling at another pump. If this does not fix the problem, consult a dealer.

Do not continue to add fuel after the nozzle has automatically stopped. Additional fuel can exceed the full tank capacity.

Improving Fuel Economy

Fuel economy depends on several conditions, including driving conditions, your driving habits, the condition of your vehicle, and loading. Depending on these and other conditions, you may or may not achieve the rated fuel economy of this vehicle.

Maintenance and Fuel Economy

You can optimize your fuel economy with proper maintenance of your vehicle. Always maintain your vehicle in accordance with the messages displayed on the information display*/multi-information display*.

- Use the recommended viscosity engine oil, displaying the API Certification Seal.
- Maintain the specified tire pressure.
- Do not load the vehicle with excess cargo.
- Keep your vehicle clean. A buildup of snow or mud on your vehicle's underside adds weight and increases wind resistance.

Improving Fuel Economy

Direct calculation is the recommended method to determine actual fuel consumed while driving.

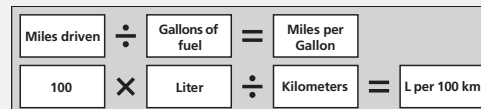

In Canada, posted fuel economy numbers are established following a simulated test. For more information on how this test is performed, please visit <http://oee.nrcan.gc.ca/>

تلفن شبانه روزی: ۰۲۱-۸۸۸۶۲۰۸۵

FarmaSOS.com

* Not available on all models

Accessories

When installing accessories, check the following:

- Do not install accessories on the windshield. They can obstruct your view and delay your reaction to driving conditions.
- Do not install accessories over areas marked **SRS AIRBAG**, on the sides or backs of the front seats, on front or side pillars, or near the side windows.
Accessories installed in these areas may interfere with proper operation of the vehicle's airbags or may be propelled into you or another occupant if the airbags deploy.
- Be sure electronic accessories do not overload electrical circuits or interfere with proper operation of your vehicle.
🔌 **Fuses** P. 562
- Before installing any electronic accessory, have the installer contact a dealer for assistance. If possible, have a dealer inspect the final installation.

Modifications

Do not modify your vehicle or use non-Honda components that can affect its handling, stability, and reliability.

Overall vehicle performance can be affected. Always make sure all equipment is properly installed and maintained, and that it meets federal, state, province, territory, and local regulations.

Accessories and Modifications

WARNING

Improper accessories or modifications can affect your vehicle's handling, stability, and performance, and cause a crash in which you can be seriously hurt or killed.

Follow all instructions in this owner's manual regarding accessories and modifications.

Honda Genuine accessories are recommended to ensure proper operation on your vehicle.

تلفن شبانه روزی: ۰۲۱-۸۸۸۶۲۰۸۵

FarmaSOS.com

Maintenance

This chapter discusses basic maintenance.

ایراد خودرو فارما

تلفن: شماره روزی: ۰۲۱-۸۸۸۶۲۰۸۸

Before Performing Maintenance

Inspection and Maintenance	484
Safety When Performing Maintenance.....	485
Parts and Fluids Used in Maintenance Service	486

Maintenance Minder™

Maintenance Under the Hood

Maintenance Items Under the Hood.....	495
Opening the Hood	497
Recommended Engine Oil	499
Oil Check	500
Adding Engine Oil	502
Changing the Engine Oil and Oil Filter	503

Engine Coolant.....	505
Transmission Fluid.....	507
Brake/Clutch Fluid.....	509
Refilling Window Washer Fluid.....	510
Replacing Light Bulbs	511
Checking and Maintaining Wiper Blades	521
Checking and Maintaining Tires	
Checking Tires	523
Tire and Loading Information Label.....	524
Tire Labeling	524
DOT Tire Quality Grading (U.S. Vehicles).....	526
Wear Indicators.....	528

Tire Service Life.....	528
Tire and Wheel Replacement	529
Tire Rotation.....	530
Winter Tires	531
Battery.....	532

Remote Transmitter Care

Replacing the Button Battery	533
------------------------------------	-----

Heating and Cooling System*/Climate Control System* Maintenance

Cleaning

Interior Care	536
Exterior Care.....	538

* Not available on all models

Inspection and Maintenance

For your safety, perform all listed inspections and maintenance to keep your vehicle in good condition. If you become aware of any abnormality (noise, smell, insufficient brake fluid, oil residue on the ground, etc.), have your vehicle inspected by a dealer. (Note, however, that service at a dealer is not mandatory to keep your warranties in effect.) Refer to the separate maintenance booklet for detailed maintenance and inspection information.

Types of Inspection and Maintenance

Daily inspections

Perform inspections before long distance trips, when washing the vehicle, or when refueling.

Periodic inspections

- Check the brake fluid level monthly.
 - **Brake/Clutch Fluid** P. 509
- Check the tire pressure monthly. Examine the tread for wear and foreign objects.
 - **Checking and Maintaining Tires** P. 523
- Check the operation of the exterior lights monthly.
 - **Replacing Light Bulbs** P. 511
- Check the condition of the wiper blades at least every six months.
 - **Checking and Maintaining Wiper Blades** P. 521

Inspection and Maintenance

U.S. models

Maintenance, replacement, or repair of emissions control devices and systems may be done by any automotive repair establishment or individuals using parts that are "certified" to EPA standards.

According to state and federal regulations, failure to perform maintenance on the maintenance main items marked with # will not void your emissions warranties. However, all maintenance services should be performed in accordance with the intervals indicated by the information display*/multi-information display*.

➤ **Maintenance Service Items** P. 489, 493

If you want to perform complex maintenance tasks that require more skills and tools, you can purchase a subscription to the Service Express website at www.techno.honda.com.

➤ **Authorized Manuals** P. 579

If you want to perform maintenance yourself, make sure that you have the necessary tools and skills first. After performing maintenance, update the records in the separate maintenance booklet.

Safety When Performing Maintenance

Some of the most important safety precautions are given here. However, we cannot warn you of every conceivable hazard that can arise in performing maintenance. Only you can decide whether or not you should perform a given task.

Maintenance Safety

- To reduce the possibility of fire or explosion, keep cigarettes, sparks, and flames away from the battery and all fuel related parts.
- Never leave rags, towels, or other flammable objects under the hood.
 - ▶ Heat from the engine and exhaust can ignite them causing a fire.
- To clean parts, use a commercially available degreaser or parts cleaner, not gasoline.
- Wear eye protection and protective clothing when working with the battery or compressed air.
- Engine exhaust contains carbon monoxide, which is poisonous and can kill you.
 - ▶ Operate the engine only when there is sufficient ventilation.

Vehicle Safety

- The vehicle must be in a stationary condition.
 - ▶ Make sure your vehicle is parked on level ground, the parking brake is set, and the engine is off.
- Be aware that hot parts can burn you.
 - ▶ Make sure to let the engine and exhaust system cool thoroughly before touching vehicle parts.
- Be aware that moving parts can injure you.
 - ▶ Do not start the engine unless instructed, and keep your hands and limbs away from moving parts.

Safety When Performing Maintenance

⚠ WARNING

Improperly maintaining this vehicle or failing to correct a problem before driving can cause a crash in which you can be seriously hurt or killed.

Always follow the inspection and maintenance recommendations according to the schedules in this owner's manual.

⚠ WARNING

Failure to properly follow maintenance instructions and precautions can cause you to be seriously hurt or killed.

Always follow the procedures and precautions in this owner's manual.

Parts and Fluids Used in Maintenance Service

The use of Honda genuine parts and fluids is recommended when maintaining and servicing your vehicle. Honda genuine parts are manufactured according to the same high quality standards used in Honda vehicles.

امداد خودرو فارما

تلفن شبانه روزی: ۰۲۱-۸۸۸۶۲۰۸۵

FarmaSOS.com



If the engine oil life is less than 15%, you will see the Maintenance Minder messages appear on the information display* or the multi-information display* every time you turn the ignition switch to ON *1. The messages notify you when to change the engine oil, or when to bring your vehicle to a dealer for indicated maintenance services.

Models with information display

To Use Maintenance Minder™

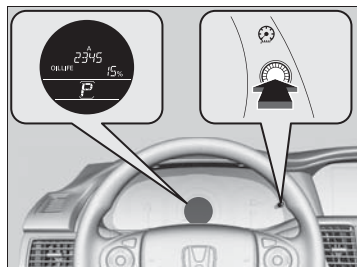
Displaying the Engine Oil Life



1. Turn the ignition switch to ON *1.
2. Press the  (Select/Reset) knob repeatedly until the engine oil life appears on the information display.

The Maintenance Minder indicator () stays on in the instrument panel after the engine oil life becomes **0%**. Have the indicated maintenance done by a dealer immediately.

Displaying the Engine Oil Life

Based on the engine operating conditions, the remaining engine oil life is calculated and displayed as a percentage.

Displayed Engine Oil Life (%)	Calculated Engine Oil Life (%)
100	100 to 91
90	90 to 81
80	80 to 71
70	70 to 61
60	60 to 51
50	50 to 41
40	40 to 31
30	30 to 21
20	20 to 16
15	15 to 11
10	10 to 6
5	5 to 1
0	0





*1: Models with the smart entry system have an **ENGINE START/STOP** button instead of an ignition switch.

* Not available on all models

Continued

Maintenance Minder Messages on the Information Display

To switch the display, press the  (Select/Reset) knob.

Oil Life Display	Explanation	Information	Maintenance Minder Indicator
	The engine oil life indicator starts to appear along with other due soon maintenance item codes when the remaining oil life becomes 15 percent.	The engine oil is approaching the end of its service life.	 Starts to come on when the remaining engine oil life becomes 15 percent.
	The SERVICE message also starts to appear along with the engine oil life indicator and the maintenance item codes.	The engine oil has almost reached the end of its service life, and the maintenance items should be inspected and serviced as soon as possible.	It goes off when the display is switched.
	The remaining engine oil life has passed its service life, and a negative distance appears after driving over 10 miles (U.S. models) or 10 km (Canadian models). The negative distance on the display blinks.	The engine oil life has passed. The maintenance items must be inspected and serviced immediately.	 Stays on as a reminder even when the display is switched.

Maintenance Service Items



Maintenance Service Items

- Independent of the Maintenance Minder information, replace the brake fluid every 3 years.
- Inspect idle speed every 160,000 miles (256,000 km).
- Adjust the valves during services A, B, 1, 2, or 3 if they are noisy.

CODE	Maintenance Main Items
A	<ul style="list-style-type: none"> • Replace engine oil*¹
B	<ul style="list-style-type: none"> • Replace engine oil*¹ and oil filter • Inspect front and rear brakes/service as necessary • Check parking brake adjustment • Inspect tie rod ends, steering gearbox, and boots • Inspect suspension components • Inspect driveshaft boots • Inspect brake hoses and lines (Including ABS/VSA) • Inspect all fluid levels and condition of fluids • Inspect exhaust system[#] • Inspect fuel lines and connections[#]

*1: If a message **SERVICE** does not appear more than 12 months after the display is reset, change the engine oil every year.

: See information on maintenance and emissions warranty.

CODE	Maintenance Sub Items
1	<ul style="list-style-type: none"> • Rotate tires
2	<ul style="list-style-type: none"> • Replace air cleaner element*² • Replace dust and pollen filter*³ • Inspect drive belt
3	<ul style="list-style-type: none"> • Replace transmission fluid*^{4, *5}
4	<ul style="list-style-type: none"> • Replace spark plugs • Replace timing belt and inspect water pump*^{6, *7} • Inspect valve clearance
5	<ul style="list-style-type: none"> • Replace engine coolant

*2: If you drive in dusty conditions, replace the air cleaner element every 15,000 miles (24,000 km).

*3: If you drive primarily in urban areas that have high concentrations of soot in the air from industry and from diesel-powered vehicles, replace the dust and pollen filter every 15,000 miles (24,000 km).

*4: Continuously variable transmission (CVT) models

*5: Driving in mountainous areas at very low vehicle speeds or trailer towing results in higher transmission temperatures. This requires transmission fluid changes more frequently than recommended by the Maintenance Minder. If you regularly drive your vehicle under these conditions, have the transmission fluid changed every 25,000 miles (40,000 km).

*6: 6-cylinder models



*7: If you drive regularly in very high temperatures (over 110 °F, 43 °C), in very low temperatures (under 20 °F, -29 °C), or tow a trailer, replace every 60,000 miles/100,000 km.

Continued

Resetting the Display

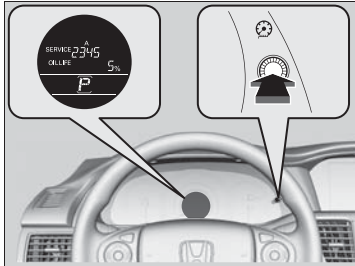
Reset the engine oil life display if you have performed the maintenance service.



1. Turn the ignition switch to ON **II***1.
2. Display the engine oil life by repeatedly pressing the  (Select/Reset) knob.
3. Press and hold the  knob for ten seconds or more.
 - The engine oil life indicator and the maintenance item codes blink.
4. Press the  knob for five seconds or more.
 - The displayed maintenance items disappear, and the engine oil life display returns to **100%**.

Resetting the Display

NOTICE

Failure to reset the engine oil life after a maintenance service results in the system showing incorrect maintenance intervals, which can lead to serious mechanical problems.

The dealer will reset the engine oil life display after completing the required maintenance service. If someone other than a dealer performs maintenance service, reset the engine oil life display yourself.

You can reset the engine oil life display using the audio/information screen.

► **Customized Features** P. 298

تلفن شبانه روزی: ۰۲۱-۸۸۸۶۲۰۸۵

FarmaSOS.com

*1: Models with the smart entry system have an **ENGINE START/STOP** button instead of an ignition switch.

Models with multi-information display

To Use Maintenance Minder™

■ Displaying the Engine Oil Life

1. Set the power mode to ON.
2. Press the  (Information) button repeatedly until the engine oil life appears on the multi-information display.

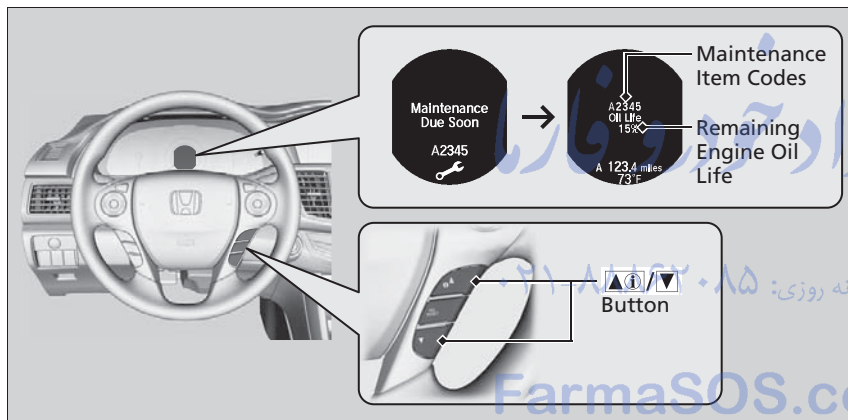









►► Displaying the Engine Oil Life

Based on the engine operating conditions, the remaining engine oil life is calculated and displayed as a percentage.

Displayed Engine Oil Life (%)	Calculated Engine Oil Life (%)
100	100 to 91
90	90 to 81
80	80 to 71
70	70 to 61
60	60 to 51
50	50 to 41
40	40 to 31
30	30 to 21
20	20 to 16
15	15 to 11
10	10 to 6
5	5 to 1
0	0

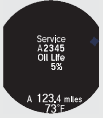
Continued

Maintenance Minder Messages on the Multi-Information Display

Maintenance Message	Oil Life Display	Explanation	Information
	15 % 	The remaining engine oil life is 15 to 6 percent. Once you switch the display by pressing the  /▼ (Information) button, this message will go off.	The engine oil is approaching the end of its service life, and the maintenance items should be inspected and serviced soon.
	5 % 	The remaining engine oil life is 5 to 1 percent. Press the  /▼ button to switch to another display.	The engine oil has almost reached the end of its service life, and the maintenance items should be inspected and serviced as soon as possible.
	Negative Distance 	The remaining engine oil life has passed its service life, and a negative distance appears after driving over 10 miles (U.S. models) or 10 km (Canadian models). Press the  /▼ button to switch to another display.	The engine oil life has passed. The maintenance items must be inspected and serviced immediately.

The system message indicator (ⓘ) comes on along with the Maintenance Minder message.

Maintenance Service Items

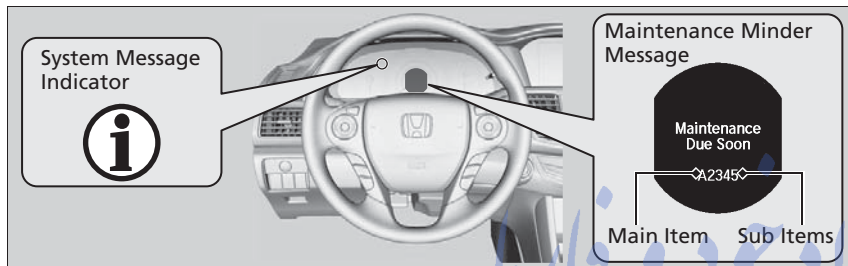

Maintenance Service Items

- Independent of the Maintenance Minder information, replace the brake fluid every 3 years.
- Inspect idle speed every 160,000 miles (256,000 km).
- Adjust the valves during services A, B, 1, 2, or 3 if they are noisy.

CODE	Maintenance Main Items
A	<ul style="list-style-type: none"> • Replace engine oil*¹
B	<ul style="list-style-type: none"> • Replace engine oil*¹ and oil filter • Inspect front and rear brakes/service as necessary • Check parking brake adjustment • Inspect tie rod ends, steering gearbox, and boots • Inspect suspension components • Inspect driveshaft boots • Inspect brake hoses and lines (Including ABS/VSA) • Inspect all fluid levels and condition of fluids • Inspect exhaust system[#] • Inspect fuel lines and connections[#]

*1: If a message **Service** does not appear more than 12 months after the display is reset, change the engine oil every year.

#: See information on maintenance and emissions warranty.

CODE	Maintenance Sub Items
1	<ul style="list-style-type: none"> • Rotate tires
2	<ul style="list-style-type: none"> • Replace air cleaner element*² • Replace dust and pollen filter*³ • Inspect drive belt
3	<ul style="list-style-type: none"> • Replace transmission fluid
4	<ul style="list-style-type: none"> • Replace spark plugs • Replace timing belt and inspect water pump*⁴ • Inspect valve clearance
5	<ul style="list-style-type: none"> • Replace engine coolant

*2: If you drive in dusty conditions, replace the air cleaner element every 15,000 miles (24,000 km).

*3: If you drive primarily in urban areas that have high concentrations of soot in the air from industry and from diesel-powered vehicles, replace the dust and pollen filter every 15,000 miles (24,000 km).

*4: If you drive regularly in very high temperatures (over 110 °F, 43 °C), in very low temperatures (under -20 °F, -29 °C), or tow a trailer, replace every 60,000 miles/100,000 km.

Resetting the Display

Reset the engine oil life display if you have performed the maintenance service.

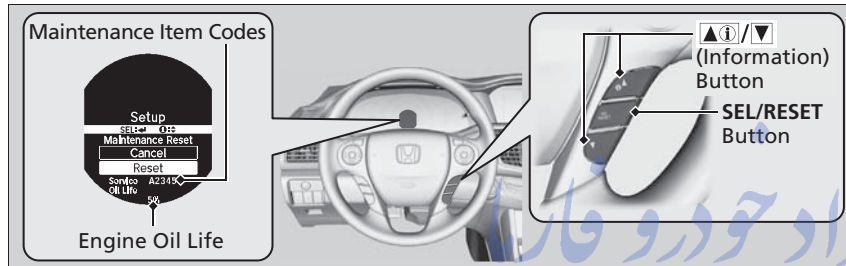

1. Set the power mode to ON.
2. Press the ▲(i)/▼ button to select **Vehicle Settings**, then press the **SEL/RESET** button.
3. Press the ▲(i)/▼ button until **Maintenance Reset** appears on the display.
4. Press the **SEL/RESET** button.
 - The oil life reset mode is displayed on the multi-information display.
5. Select **Reset** with the ▲(i)/▼ button, then press the **SEL/RESET** button.
 - The displayed maintenance items disappear, and the engine oil life display returns to **100%**.

To cancel the oil life reset mode, select **Cancel**, then press the **SEL/RESET** button.

Resetting the Display

NOTICE

Failure to reset the engine oil life after a maintenance service results in the system showing incorrect maintenance intervals, which can lead to serious mechanical problems.

The dealer will reset the engine oil life display after completing the required maintenance service. If someone other than a dealer performs maintenance service, reset the engine oil life display yourself.

You can reset the engine oil life display using the audio/information screen.

► **Customized Features** P. 298

Maintenance Items Under the Hood

4-cylinder models

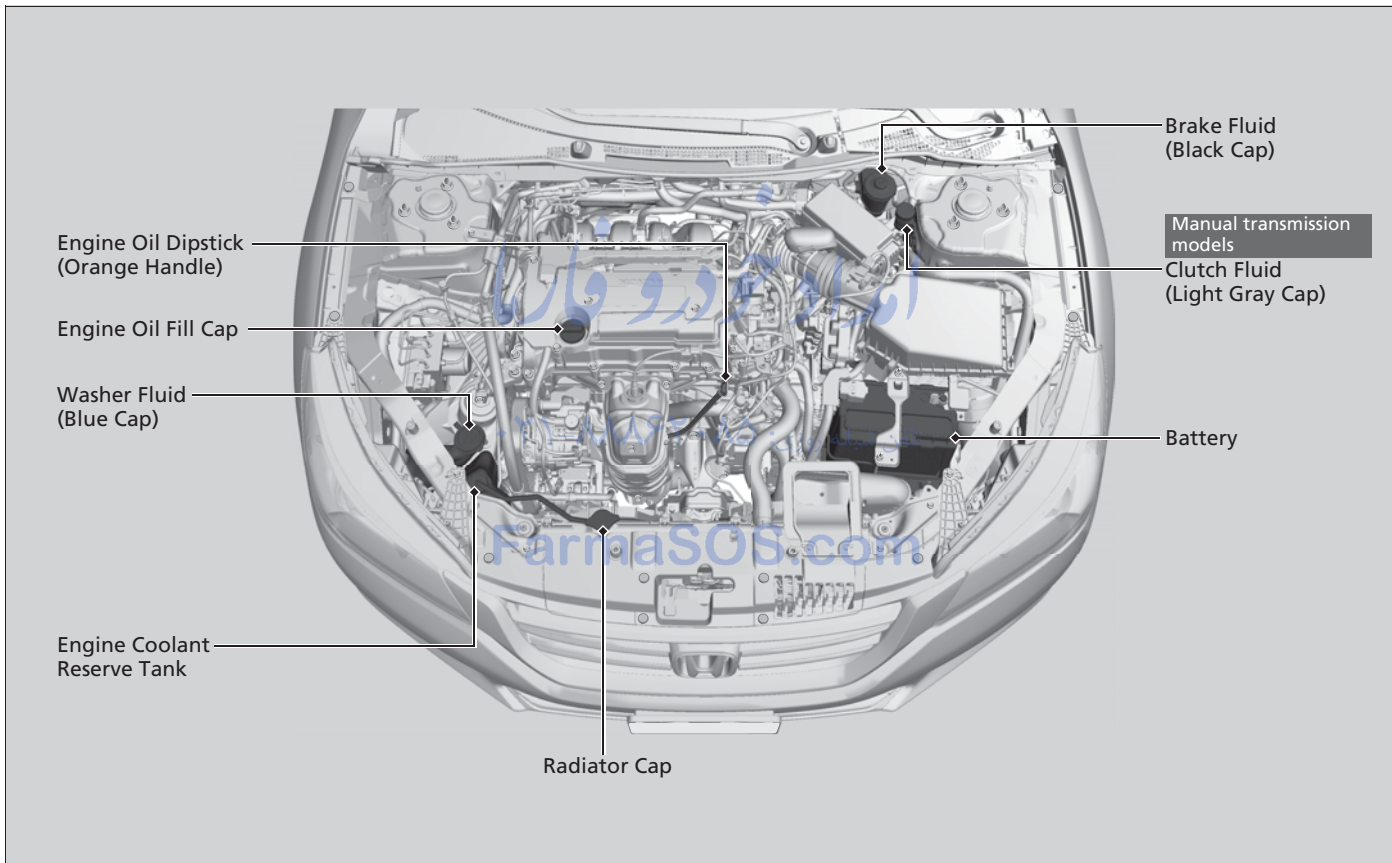

6-cylinder models

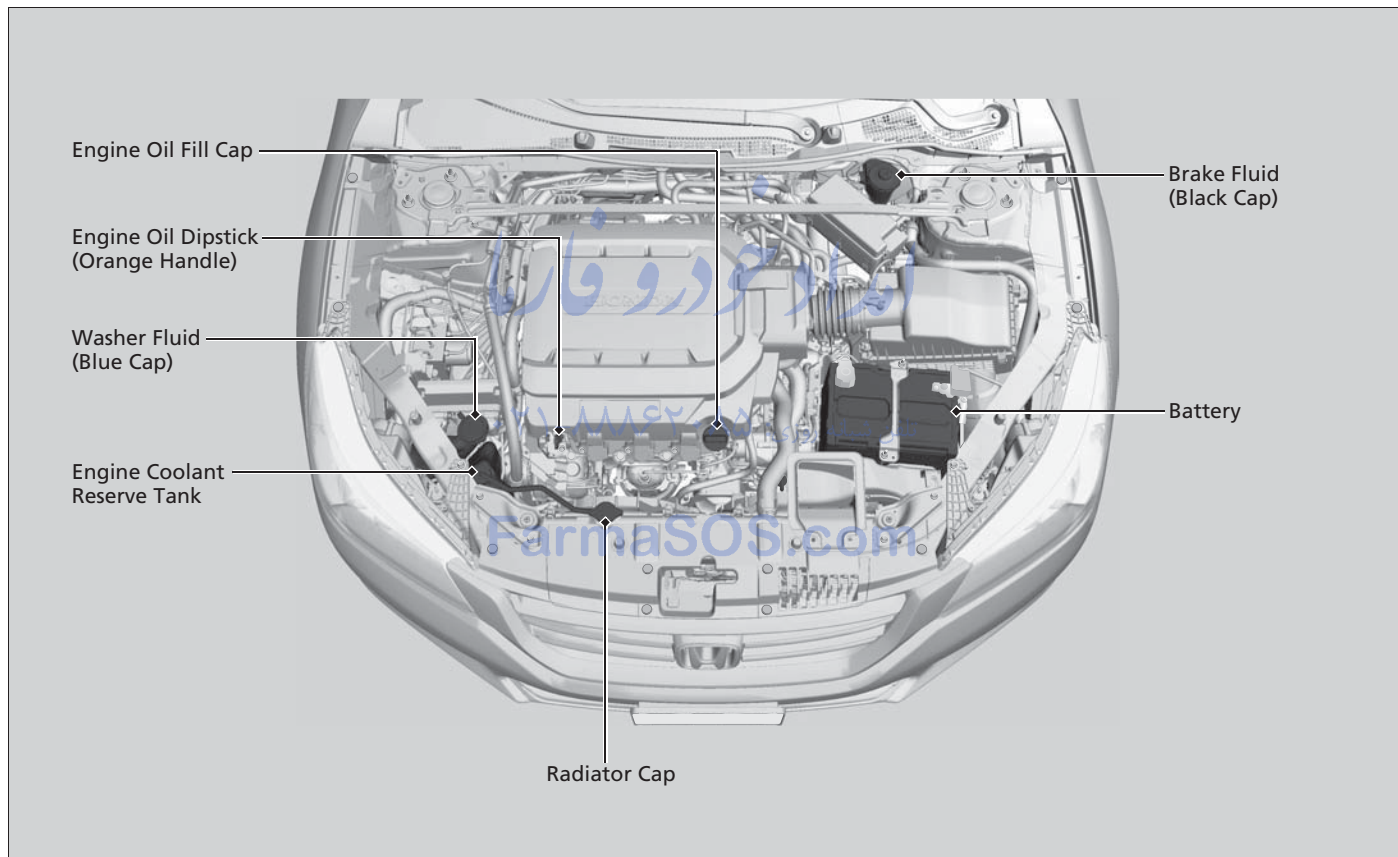

Opening the Hood

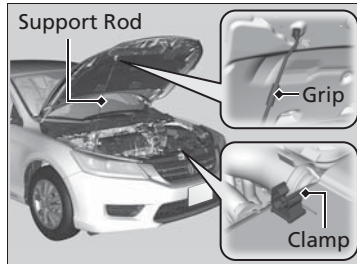
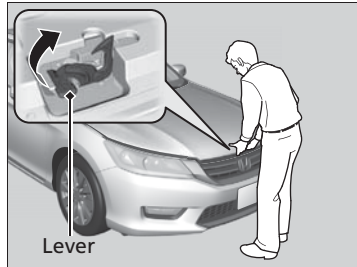

1. Park the vehicle on a level surface, and set the parking brake.
2. Pull the hood release handle under the lower left corner of the dashboard.
 - The hood will pop up slightly.
3. Push up the hood latch lever in the center of the hood to release the lock mechanism, and open the hood.

4-cylinder models

4. Remove the support rod from the clamp using the grip. Mount the support rod in the hood.

When closing, remove the support rod, and stow it in the clamp, then gently lower the hood. Remove your hand at a height of approximately 12 inches (30 cm) and let the hood close.

Opening the Hood

NOTICE

Do not open the hood when the wiper arms are raised. The hood will strike the wipers, and may damage either the hood or the wipers.

When closing the hood, check that the hood is securely latched.

If the hood latch lever moves stiffly, or if you can open the hood without lifting the lever, the latch mechanism should be cleaned and lubricated.

تلفن شبانه روزی: ۰۲۱-۸۸۸۶۲۰۸۵

parmaSOS.com

Continued



6-cylinder models

4. Lift the hood up most of the way.
 - The hydraulic supports will lift it up the rest of the way and hold it up.

When closing, lower it to approximately 12 inches (30 cm), then press down firmly with your hands.

امداد خودرو فارما

تلفن شبانه روزی: ۰۲۱-۸۸۸۶۲۰۸۵

FarmaSOS.com

Recommended Engine Oil

- **Genuine Honda Motor Oil**
- **Premium-grade 0W-20 detergent oil with an API Certification Seal on the container.**



Oil is a major contributor to your engine's performance and longevity. If you drive the vehicle with insufficient or deteriorated oil, the engine may fail or be damaged.

This seal indicates the oil is energy conserving and that it meets the American Petroleum Institute's latest requirements.

Use Genuine Honda Motor Oil or another commercial engine oil of suitable viscosity for the ambient temperature as shown here.

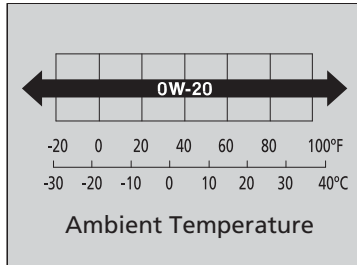

■ Synthetic oil

You may also use synthetic motor oil if it is labeled with the API Certification Seal and is the specified viscosity grade.

▣ Recommended Engine Oil

Engine Oil Additives

Your vehicle does not require oil additives. In fact, they may adversely affect the engine performance and durability.

FarmaSOS.com

Oil Check

We recommend that you check the engine oil level every time you refuel.

Park the vehicle on level ground.

Wait approximately three minutes after turning the engine off before you check the oil.

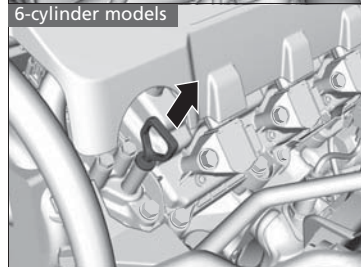
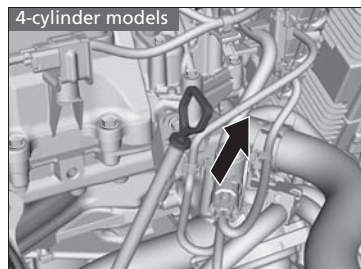

1. Remove the dipstick (orange handle).
2. Wipe the dipstick with a clean cloth or paper towel.
3. Insert the dipstick back all the way into its hole.

امداد خودرو فارما

تلفن شبانه روزی: ۰۲۱-۸۸۸۶۲۰۸۵

FarmaSOS.com

Oil Check

If the oil level is near or below the lower mark, slowly add oil being careful not to overfill.

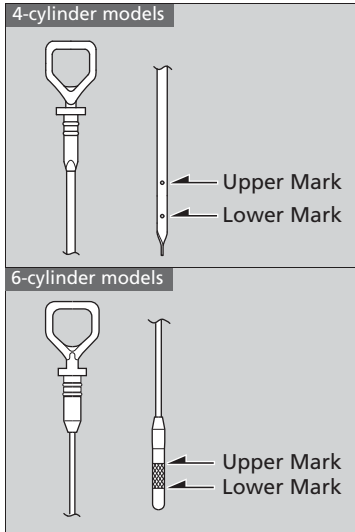

4. Remove the dipstick again, and check the level. It should be between the upper and lower marks. Add oil if necessary.

امداد خودرو فارما

تلفن شبانه روزی: ۰۲۱-۸۸۸۶۲۰۸۵

FarmaSOS.com

Adding Engine Oil

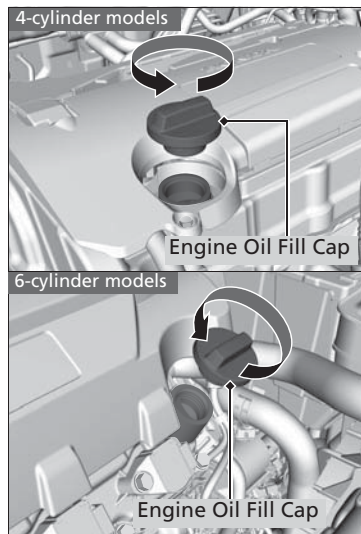

1. Unscrew and remove the engine oil fill cap.
2. Add oil slowly.
3. Reinstall the engine oil fill cap, and tighten it securely.
4. Wait for three minutes and recheck the engine oil dipstick.

► Adding Engine Oil

If any oil spills, wipe it away immediately. Spilled oil may damage the engine compartment components.

NOTICE

Do not fill the engine oil above the upper mark. Overfilling the engine oil can result in leaks and engine damage.

امداد خودرو فارما

تلفن شبانه روزی: ۰۲۱-۸۸۸۶۲۰۸۵

FarmaSOS.com

Changing the Engine Oil and Oil Filter

You must change the engine oil and oil filter regularly in order to maintain the engine's lubrication. The engine may be damaged if they are not changed regularly.

Change the oil and filter in accordance with the maintenance message on the information display*/multi-information display*.

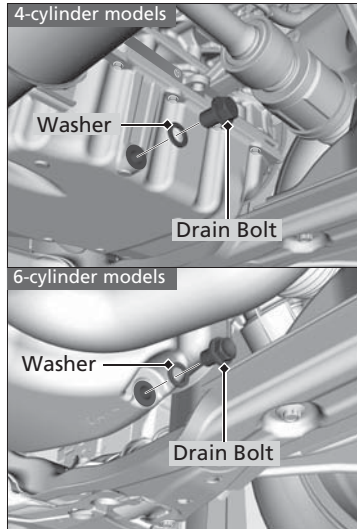

1. Run the engine until it reaches normal operating temperature, and then turn the engine off.
2. Open the hood and remove the engine oil fill cap.
3. Remove the drain bolt and washer from the bottom of the engine, and drain the oil into a suitable container.

تلفن شبانه روزی: ۰۲۱-۸۸۸۶۲۰۸۵

FarmaSOS.com

Changing the Engine Oil and Oil Filter

NOTICE

You may damage the environment if you do not dispose of the oil in a suitable way. If you are changing the oil by yourself, appropriately dispose of the used oil. Put the oil in a sealed container and take it to a recycling center. Do not throw the oil away into a garbage can or onto the ground.

* Not available on all models

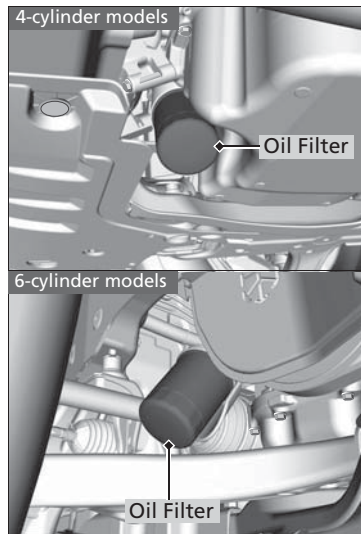

4. Remove the oil filter and dispose of the remaining oil.
5. Check that the filter gasket is not stuck to the engine contact surface.
 - If it is stuck, you must detach it.
6. Wipe away dirt and dust adhering to the contact surface of the engine block, and install a new oil filter.
 - Apply a light coat of new engine oil to the oil gasket.
7. Put a new washer on the drain bolt, then reinstall the drain bolt.
 - Tightening torque:
 - 4-cylinder models**
30 lbf·ft (40 N·m, 4.0 kgf·m)
 - 6-cylinder models**
29 lbf·ft (39 N·m, 4.0 kgf·m)
8. Pour the recommended engine oil into the engine.
 - Engine oil change capacity (including filter):
 - 4-cylinder models**
4.4 US qt (4.2 L)
 - 6-cylinder models**
4.5 US qt (4.3 L)
9. Reinstall the engine oil fill cap securely and start the engine.
10. Run the engine for a few minutes, and then check that there is no leak from the drain bolt or oil filter.
11. Stop the engine, wait for three minutes, and then check the oil level on the dipstick.
 - If necessary, add more engine oil.

► Changing the Engine Oil and Oil Filter

You will need a special wrench to replace the oil filter. You can buy this wrench from a dealer.

When installing the new oil filter, follow the instructions supplied with the oil filter.

Reinstall the engine oil fill cap. Start the engine. The low oil pressure indicator should go off within five seconds. If it does not, turn off the engine, and check your work.

Engine Coolant

Specified coolant: Honda Long Life Antifreeze/Coolant Type 2

This coolant is premixed with 50% antifreeze and 50% water. Do not add any straight antifreeze or water.

We recommend you check the engine coolant level every time you refuel. Check the reserve tank first. If it is completely empty, also check the coolant level in the radiator. Add the engine coolant accordingly.

Reserve Tank

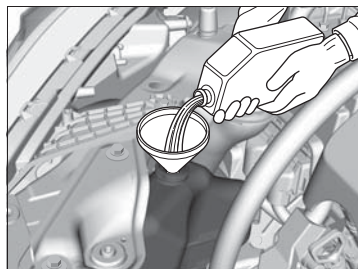
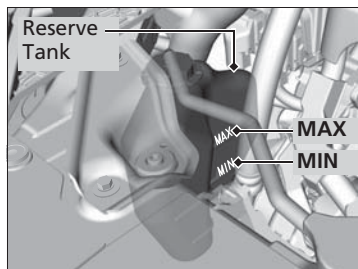

1. Check the amount of coolant in the reserve tank.
2. If the coolant level is below the **MIN** mark, add the specified coolant until it reaches the **MAX** mark.
3. Inspect the cooling system for leaks.

Engine Coolant

NOTICE

If temperatures consistently below -22°F (-30°C) are expected, the coolant mixture should be changed to a higher concentration. Consult a dealer for more information.

If Honda antifreeze/coolant is not available, you may use another major brand non-silicate coolant as a temporary replacement. Check that it is a high quality coolant recommended for aluminum engines. Continued use of any non-Honda coolant can result in corrosion, causing the cooling system to malfunction or fail. Have the cooling system flushed and refilled with Honda antifreeze/coolant as soon as possible.

Do not add rust inhibitors or other additives to your vehicle's cooling system. They may not be compatible with the coolant or with the engine components.

فارما سوس فارما
تلفن شبانه روزی: ۰۲۱-۸۸۸۶۲۰۸۵
FarmaSOS.com

Continued

Radiator

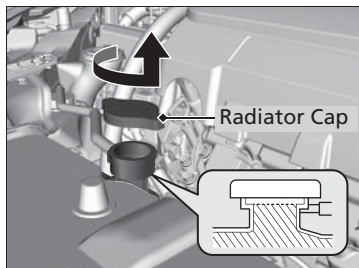

1. Make sure the engine and radiator are cool.
2. Turn the radiator cap counterclockwise to relieve any pressure in the cooling system. Do not push the cap down when turning.
3. Push down and turn the radiator cap counterclockwise to remove it.
4. The coolant level should be up to the base of the filler neck. Add coolant if it is low.
5. Put the radiator cap back on, and tighten it fully.
6. Pour coolant into the reserve tank until it reaches the **MAX** mark. Put the cap back on the reserve tank.

Radiator

⚠ WARNING

Removing the radiator cap while the engine is hot can cause the coolant to spray out, seriously scalding you.

Always let the engine and radiator cool down before removing the radiator cap.

NOTICE

Pour the fluid slowly and carefully so you do not spill any. Clean up any spills immediately; they can damage components in the engine compartment.

Transmission Fluid

4-cylinder models with continuously variable transmission (CVT)

Continuously Variable Transmission (CVT) Fluid

Specified fluid: HCF-2

Have a dealer check the fluid level and replace if necessary.

4-cylinder models with manual transmission

Manual Transmission Fluid

Specified fluid: Honda Manual Transmission Fluid (MTF)

Have a dealer check the fluid level and replace if necessary.

►► Continuously Variable Transmission (CVT) Fluid

NOTICE

Do not mix HCF-2 with other transmission fluids.

Using a transmission fluid other than HCF-2 may adversely affect the operation and durability of your vehicle's transmission, and damage the transmission. Any damage caused by using a transmission fluid that is not equivalent to HCF-2 is not covered by Honda's new vehicle warranty.

►► Manual Transmission Fluid

If Honda MTF is not available, you may use the API certificated SAE 0 W-20 or 5 W-20 viscosity motor oil as a temporary measure.

Replace with MTF as soon as possible. Motor oil does not contain the proper additives for the transmission and continued use can cause decreased shifting performance and lead to transmission damage.

FarmaSOS.com

6-cylinder models

Automatic Transmission Fluid

Specified fluid: Honda ATF DW-1 (automatic transmission fluid)

Have a dealer check the fluid level and replace if necessary.

► Automatic Transmission Fluid

NOTICE

Do not mix Honda ATF DW-1 with other transmission fluids.

Using a transmission fluid other than Honda ATF DW-1 may adversely affect the operation and durability of your vehicle's transmission, and damage the transmission.

Any damage caused by using a transmission fluid that is not equivalent to Honda ATF DW-1 is not covered by Honda's new vehicle warranty.

امداد خودرو فارما

تلفن شبانه روزی: ۰۲۱-۸۸۸۶۲۰۸۵

FarmaSOS.com

Brake/Clutch Fluid

Specified fluid: Honda Heavy Duty Brake Fluid DOT 3

Use the same fluid for both the brakes and clutch.

Checking the Brake Fluid

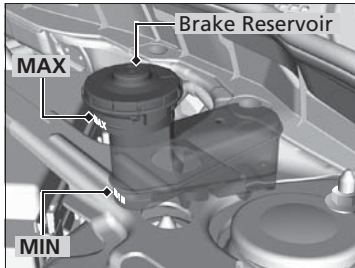

The fluid level should be between the **MIN** and **MAX** marks on the side of the reservoir.

Manual transmission models

Checking the Clutch Fluid

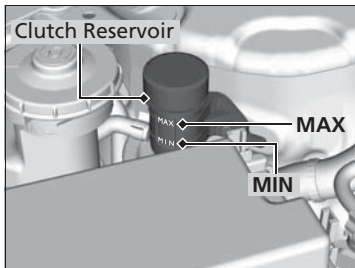

The fluid level should be between the **MIN** and **MAX** marks on the side of the reservoir.

Brake/Clutch Fluid

NOTICE

Brake fluid marked DOT 5 is not compatible with your vehicle's braking system and can cause extensive damage.

If the specified brake fluid is not available, you should use only DOT 3 or DOT 4 fluid from a sealed container as a temporary replacement.

Using any non-Honda brake fluid can cause corrosion and decrease the longevity of the system. Have the brake system flushed and refilled with Honda Heavy Duty Brake Fluid DOT 3 as soon as possible.

If the brake fluid level is at or below the **MIN** mark, have a dealer inspect the vehicle for leaks or worn brake pads as soon as possible.

Checking the Clutch Fluid

If the clutch fluid level is at or below the **MIN** mark, have a dealer inspect for leaks or an excessively worn clutch plate as soon as possible.

امداد خودرو فارما

تلفن شبانه روزی: ۰۲۱-۸۸۸۶۲۰۸۵

FarmaSOS.com

Refilling Window Washer Fluid

Check the amount of window washer fluid by looking at the reservoir.

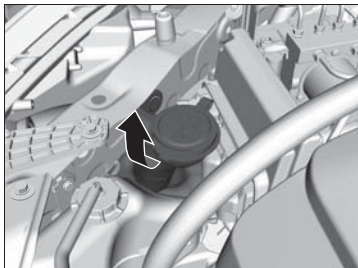

If the level is low, fill the washer reservoir.

Canadian models

If the washer fluid is low, the washer level indicator comes on.

Pour the washer fluid carefully. Do not overflow the reservoir.

► Refilling Window Washer Fluid

NOTICE

Do not use engine antifreeze or a vinegar/water solution in the windshield washer reservoir. Antifreeze can damage your vehicle's paint. A vinegar/water solution can damage the windshield washer pump.

امداد خودرو فارما

تلفن شبانه روزی: ۰۲۱-۸۸۸۶۲۰۸۵

FarmaSOS.com

Headlight Bulbs

When replacing, use the following bulbs.

High beam headlight: 60 W (HB3 for halogen bulb type)

Low beam headlight: LED type*

Low beam headlight: 55 W (H11 for halogen bulb type)*

High Beam Headlight

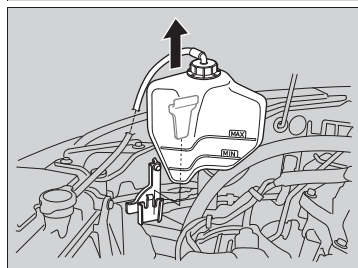
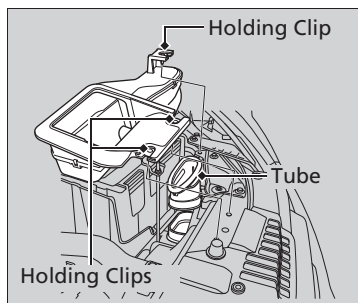

Driver side

6-cylinder models

1. Unlock the holding clips, then remove the upper part of the air intake duct and the air intake tube.

Passenger side

All models

1. Remove the reserve tank.

Headlight Bulbs

NOTICE

Halogen bulbs get very hot when lit. Oil, perspiration, or a scratch on the glass can cause the bulb to overheat and shatter.

The headlight aim is set by the factory, and does not need to be adjusted. However, if you regularly carry heavy items in the trunk or tow a trailer, have the aiming readjusted at a dealer or by a qualified technician.

When replacing a halogen bulb, handle it by its base, and protect the glass from contact with your skin or hard objects. If you touch the glass, clean it with denatured alcohol and a clean cloth.

تلفن شبانه روزی: ۰۲۱-۸۸۸۶۲۰۸۵

ArmaSOS.com

* Not available on all models

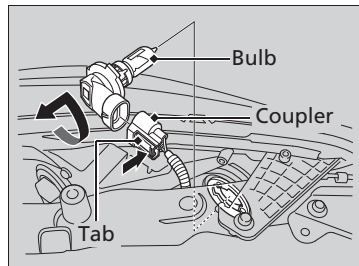

2. Push the tab to remove the coupler.
3. Rotate the old bulb to the left to remove.
4. Insert a new bulb into the headlight assembly and turn it to the right.
5. Insert the coupler into the connector of the bulb.

► High Beam Headlight

Holding clip

Press down the center pin until it clicks to unlock it.

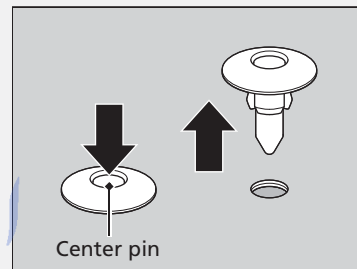

Push the center pin back to lock the clip. Then, insert the clip into the hole and press on the center pin until it is flat.

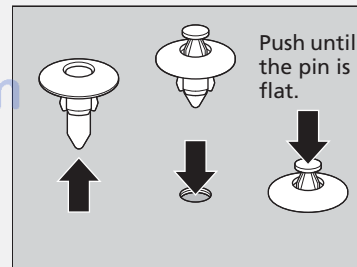

امداد خودرو فارما

تلفن شبانه روزی: ۰۲۱-۸۸۸۶۲۰۸۵

FarmaSOS.com

Low Beam Headlights

Models with halogen low beam headlights

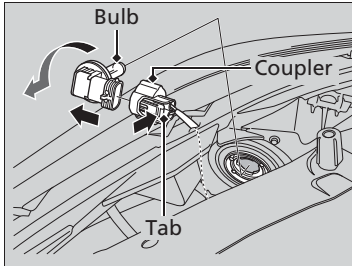

1. Push the tab to remove the coupler.
2. Rotate the old bulb to the left to remove.
3. Insert a new bulb into the headlight assembly and turn it to the right.
4. Insert the coupler into the connector of the bulb.

امداد خودرو فارما

Low Beam Headlights

Models with LED low beam headlights

Low beam headlight bulbs are LED type. Have an authorized Honda dealer inspect and replace the light assembly.

Fog Light Bulbs*

NOTICE

Halogen bulbs get very hot when lit. Oil, perspiration, or a scratch on the glass can cause the bulb to overheat and shatter.

When replacing a halogen bulb, handle it by its plastic case, and protect the glass from contact with your skin or hard objects. If you touch the glass, clean it with denatured alcohol and a clean cloth.

Fog Light Bulbs*

When replacing, use the following bulbs.

Fog Light: 35 W (H8 for halogen bulb type)

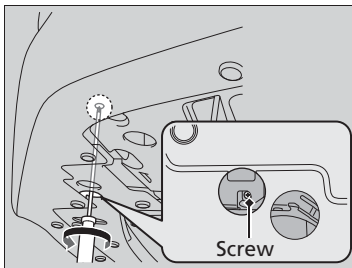

Driver side

1. Loosen the screw using a Phillips-head screwdriver.
 - ▶ Be careful not to rotate the screwdriver more than one or two times to the left. The screw may drop down.

* Not available on all models

Continued

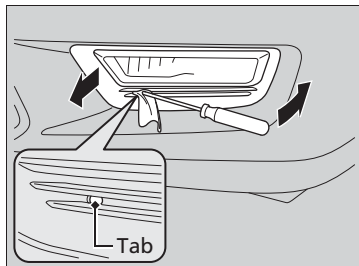

2. Insert a flat-tip screwdriver into the tab on the cover, then pull straight out as indicated to remove the cover.

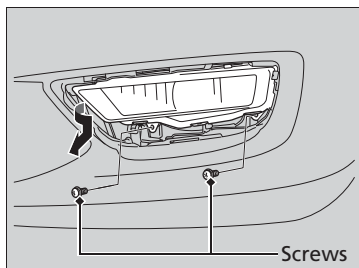

3. Remove the screws using a Phillips-head screwdriver and carefully pull the fog light assembly out of the bumper.

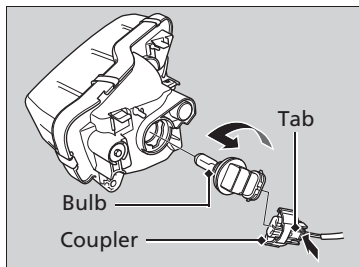

4. Push the tab to remove the coupler.
5. Rotate the old bulb to the left to remove.
6. Insert a new bulb into the fog light assembly and turn it to the right.
7. Insert the coupler into the connector of the bulb.

تلفن شبانه روزی: ۰۲۱-۸۸۸۶۲۰۸۵

www.farshad.com

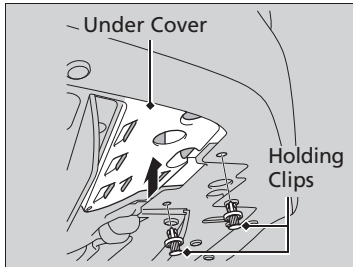
**Passenger side**

1. Remove the holding clips, then push up the under cover.

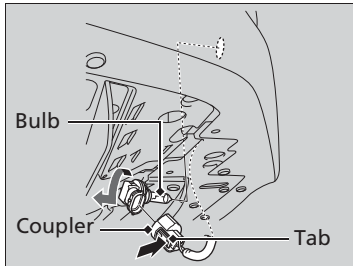

2. Push the tab to remove the coupler.

3. Rotate the old bulb to the left to remove.

4. Insert a new bulb into the fog light assembly and turn it to the right.

5. Insert the coupler into the connector of the bulb.

تلفن شبانه روزی: ۰۲۱-۸۸۸۶۲۰۸۵

FarmaSOS.com

Front Turn Signal/Side Marker Light Bulbs

When replacing, use the following bulbs.

Front Turn Signal/Side Marker Light: 27/8 W (Amber)

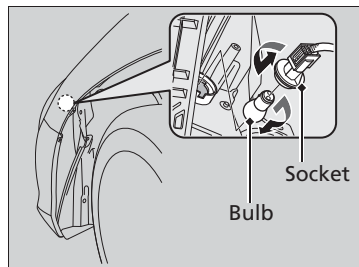
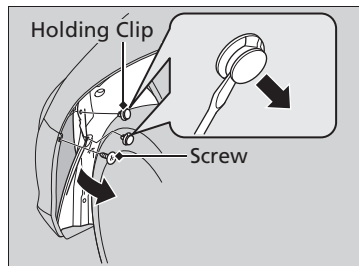

1. Turn the steering wheel all the way to the opposite side from the light being replaced.
Passenger side: Turn the steering wheel to the left.
Driver side: Turn the steering wheel to the right.
2. Remove the holding clips and screw, and pull the inner fender back.
3. Turn the socket to the left and remove it.
4. Push in the old bulb, rotate to the left until it unlocks, and remove.
5. Insert a new bulb.

Front Turn Signal/Side Marker Light Bulbs

Insert a flat-tip screwdriver, lift and remove the center pin to remove the clip.

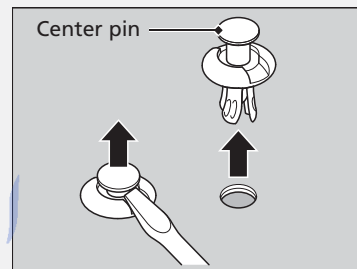

Insert the clip with the center pin raised, and push until it is flat.

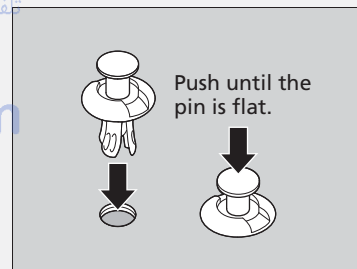

Side Turn Signal/Emergency Indicator Light Bulbs*

Door mirrors have the side turn lights. Have an authorized Honda dealer inspect and replace the light assembly.

Models with LED type parking/daytime running lights

Parking/Daytime Running Light Bulbs

Parking/daytime running light bulbs are LED type. Have an authorized Honda dealer inspect and replace the light assembly.

Models with bulb type parking lights

Parking Light Bulbs

When replacing, use the following bulbs.

Parking Light: 5 W

Turn the steering wheel and pull the inner fender back in the same way as when replacing the front turn signal/side marker light bulbs.

🔧 **Front Turn Signal/Side Marker Light Bulbs** P. 516

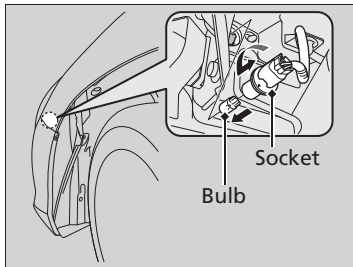

1. Turn the socket to the left and remove it, then remove the old bulb.
2. Insert a new bulb.

FarmaSOS.com

Brake/Taillight and Rear Turn Signal Light/Rear Side Marker Light Bulbs

When replacing, use the following bulbs.

Models with LED type brake/taillight

Brake/Taillight: LED

Rear Turn Signal Light: 21 W (Amber)

Rear Side Marker Light: LED

Models with bulb type brake/taillight

Brake/Taillight/Rear Side Marker Light: 21/5 W

Rear Turn Signal Light: 21 W (Amber)

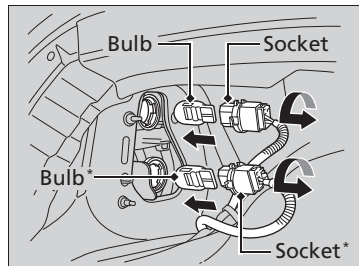
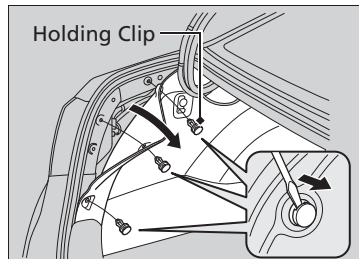

1. Remove the holding clips using a flat-tip screwdriver, then pull the lining back.

2. Turn the socket to the left and remove it.
3. Remove the old bulb and insert a new bulb.

► Brake/Taillight and Rear Turn Signal Light/Rear Side Marker Light Bulbs

Models with LED type brake/taillight

Brake/taillight and rear side marker light bulbs are LED type. Have an authorized Honda dealer inspect and replace the light assembly.

When removing the clip, insert a flat-tip screwdriver, then lift and remove the clip.

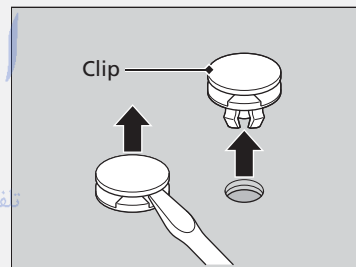

Insert the clip with the pin raised, and push until it is flat.

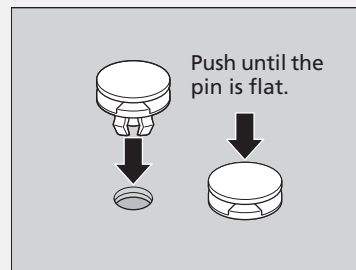

Taillight and Back-Up Light Bulbs

When replacing, use the following bulbs.

Back-Up Light: 16 W

Models with LED type taillight

Taillight: LED

Models with bulb type taillight

Taillight: 3 CP

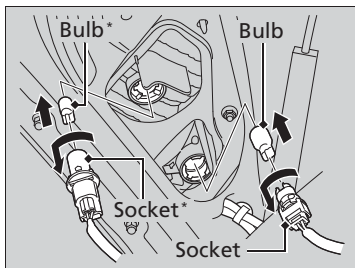
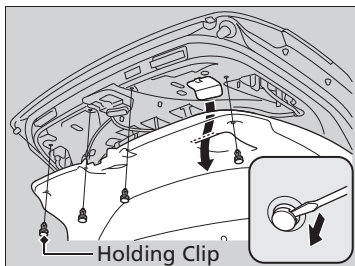

1. Remove the holding clips using a flat-tip screwdriver, then pull the lining back.

► Brake/Taillight and Rear Turn Signal Light/Rear Side Marker Light Bulbs

P. 518

2. Turn the socket to the left and remove it.
3. Remove the old bulb and insert a new bulb.

► Taillight and Back-Up Light Bulbs

Models with LED type taillight

Taillight bulbs are LED type. Have an authorized Honda dealer inspect and replace the light assembly.

تلفن شبانه روزی: ۰۲۱-۸۸۸۶۲۰۸۵

FarmaSOS.com

* Not available on all models

Rear License Plate Light Bulbs

When replacing, use the following bulbs.

Rear License Plate Light: 5 W

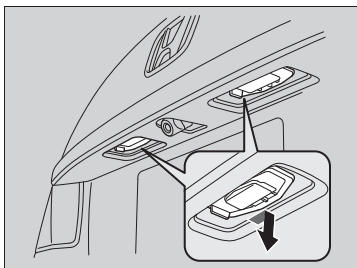

1. Remove the license plate light assembly by pushing the left edge of the lens toward the right and pulling the assembly out.

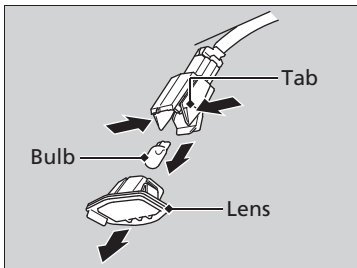

2. Remove the lens by pushing the tabs.
3. Remove the old bulb and insert a new bulb.

امداد خودرو فارما

تلفن شبانه روزی: ۰۲۱-۸۸۸۶۲۰۸۵

FarmaSOS.com

High-Mount Brake Light Bulbs

High-mount brake light bulbs are the LED type. Have an authorized Honda dealer inspect and replace the light assembly.

Checking Wiper Blades

If the wiper blade rubber has deteriorated, it will leave streaks and the hard surfaces of the blade may scratch the window glass.

Changing the Wiper Blade Rubber

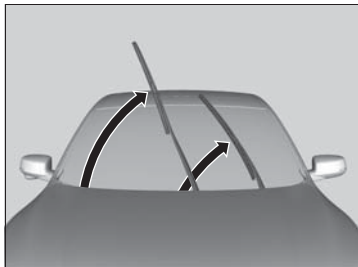

1. Lift the driver side wiper arm first, then the passenger side.

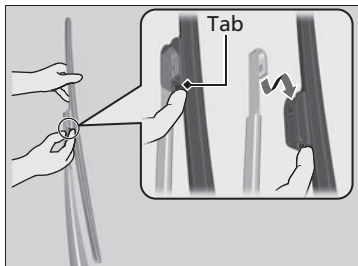

2. Press and hold the tab, then slide the blade from the wiper arm.

Changing the Wiper Blade Rubber

NOTICE

Avoid dropping the wiper arm; it may damage the windshield.

امداد خودرو فارما

FarmaSOS.com

Continued

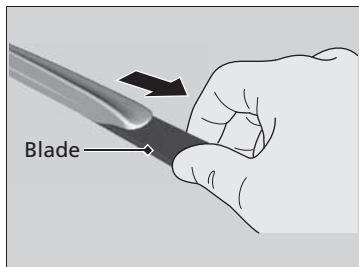

3. Slide the wiper blade out from its holder by pulling the tabbed end out.

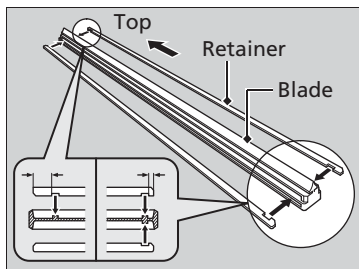

4. Remove the retainers from the rubber blade that has been removed, and mount to a new rubber blade.
 - ▶ Correctly align the rubber protrusion and the retainer grooves.

تلفن شبانه روزی: ۰۲۱-۸۸۸۶۲۰۸۵

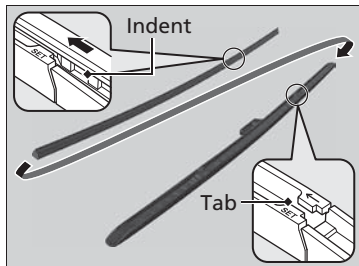

5. Slide the new wiper blade onto the holder from the bottom end.
 - ▶ The tab on the holder should fit in the indent of the wiper blade.
6. Slide the wiper blade onto the wiper arm, then push down the lock tab.
7. Lower the passenger side wiper arm first, then the driver side.

Checking Tires

To safely operate your vehicle, your tires must be of the proper type and size, in good condition with adequate tread, and properly inflated.

■ Inflation guidelines

Properly inflated tires provide the best combination of handling, tread life, and comfort. Refer to the driver's doorjamb label or specification's page for the specified pressure.

Underinflated tires wear unevenly, adversely affect handling and fuel economy, and are more likely to fail from overheating.

Overinflated tires make your vehicle ride harshly, are more prone to road hazards, and wear unevenly.

Every day before you drive, look at each of the tires. If one looks lower than the others, check the pressure with a tire gauge.

At least once a month or before long trips, use a gauge to measure the pressure in all tires, including the spare. Even tires in good condition can lose 1 to 2 psi (10 to 20 kPa, 0.1 to 0.2 kgf/cm²) per month.

■ Inspection guidelines

Every time you check inflation, also examine the tires and valve stems.

Look for:

- Bumps or bulges on the side or in the tread. Replace the tire if you find any cuts, splits, or cracks in the side of the tire. Replace it if you see fabric or cord.
- Remove any foreign objects and inspect for air leaks.
- Uneven tread wear. Have a dealer check the wheel alignment.
- Excessive tread wear.

➤ **Wear Indicators** P. 528

- Cracks or other damage around valve stem.

☒ Checking Tires

⚠ WARNING

Using tires that are excessively worn or improperly inflated can cause a crash in which you can be seriously hurt or killed.

Follow all instructions in this owner's manual regarding tire inflation and maintenance.

Measure the air pressure when tires are cold. This means the vehicle has been parked for at least three hours, or driven less than 1 mile (1.6 km). If necessary, add or release air until the specified pressure is reached.

If checked when hot, tire pressure can be as much as 4–6 psi (30–40 kPa, 0.3–0.4 kgf/cm²) higher than if checked when cold.

Whenever tire pressure is adjusted, you must calibrate the TPMS.

➤ **TPMS Calibration** P. 468

Have a dealer check the tires if you feel a consistent vibration while driving. New tires and any that have been removed and reinstalled should be properly balanced.

Tire and Loading Information Label

The label attached to the driver's doorjamb provides necessary tire and loading information.

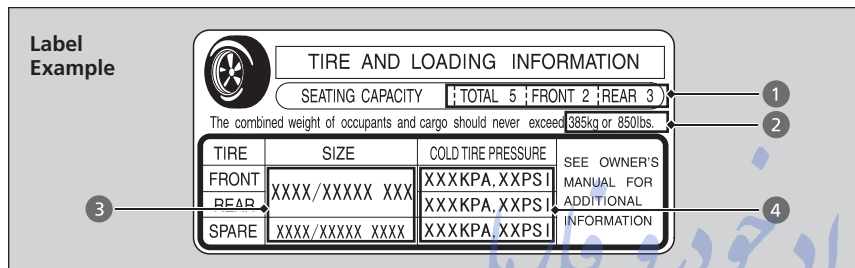

►► Tire and Loading Information Label

The tire and loading information label attached to the driver's doorjamb contains:

- 1 The number of people your vehicle can carry.
- 2 The total weight your vehicle can carry. Do not exceed this weight.
- 3 The original tire sizes for front, rear, and spare.
- 4 The proper cold tire pressure for front, rear, and spare.

Tire Labeling

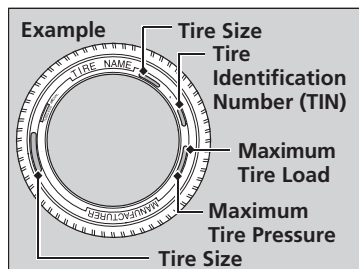

The tires that came on your vehicle have a number of markings. Those you should be aware of are described below.

►► Tire Sizes

Following is an example of tire size with an explanation of what each component means.

215/55R17 94V

215: Tire width in millimeters.

55: Aspect ratio (the tire's section height as a percentage of its width).

R: Tire construction code (R indicates radial).

17: Rim diameter in inches.

94: Load index (a numerical code associated with the maximum load the tire can carry).

V: Speed symbol (an alphabetical code indicating the maximum speed rating).

■ Tire Sizes

Whenever tires are replaced, they should be replaced with tires of the same size.

■ Tire Identification Number (TIN)

The tire identification number (TIN) is a group of numbers and letters that look like the example in the side column. TIN is located on the sidewall of the tire.

■ Glossary of Tire Terminology

Cold Tire Pressure – The tire air pressure when the vehicle has been parked for at least three hours or driven less than 1 mile (1.6 km).

Load Rating – Means the maximum load that a tire is rated to carry for a given inflation pressure.

Maximum Inflation Pressure – The maximum tire air pressure that the tire can hold.

Maximum Load Rating – Means the load rating for a tire at the maximum permissible inflation pressure for that tire.

Recommended Inflation Pressure – The cold tire inflation pressure recommended by the manufacturer.

Treadwear Indicators (TWI) – Means the projections within the principal grooves designed to give a visual indication of the degrees of wear of the tread.

■ Tire Identification Number (TIN)

DOT B97R FW6X 2209

DOT: This indicates that the tire meets all requirements of the U.S. Department of Transportation.

B97R: Manufacturer's identification mark.

FW6X: Tire type code.

22 09: Date of manufacture.

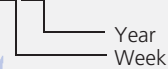

DOT Tire Quality Grading (U.S. Vehicles)

The tires on your vehicle meet all U.S. Federal Safety Requirements. All tires are also graded for treadwear, traction, and temperature performance according to Department of Transportation (DOT) standards. The following explains these gradings.

Uniform Tire Quality Grading

Quality grades can be found where applicable on the tire sidewall between tread shoulder and maximum section width.

Treadwear

The treadwear grade is a comparative rating based on the wear rate of the tire when tested under controlled conditions on a specified government test course. For example, a tire graded 150 would wear one and one-half (1 1/2) times as well on the government course as a tire graded 100. The relative performance of tires depends upon the actual conditions of their use, however, and may depart significantly from the norm due to variations in driving habits, service practices and differences in road characteristics and climate.

Uniform Tire Quality Grading

For example:
Treadwear 200
Traction AA
Temperature A

All passenger car tires must conform to Federal Safety Requirements in addition to these grades.

■ Traction

The traction grades, from highest to lowest, are AA, A, B, and C. Those grades represent the tire's ability to stop on wet pavement as measured under controlled conditions on specified government test surfaces of asphalt and concrete. A tire marked C may have poor traction performance.

■ Temperature

The temperature grades are A (the highest), B, and C, representing the tire's resistance to the generation of heat and its ability to dissipate heat when tested under controlled conditions on a specified indoor laboratory test wheel. Sustained high temperature can cause the material of the tire to degenerate and reduce tire life, and excessive temperature can lead to sudden tire failure. The grade C corresponds to a level of performance which all passenger car tires must meet under the Federal Motor Vehicle Safety Standard No. 109. Grades B and A represent higher levels of performance on the laboratory test wheel than the minimum required by law.

☒ Traction

Warning: The traction grade assigned to this tire is based on straight-ahead braking traction tests, and does not include acceleration, cornering, hydroplaning, or peak traction characteristics.

☒ Temperature

Warning: The temperature grade for this tire is established for a tire that is properly inflated and not overloaded. Excessive speed, underinflation, or excessive loading, either separately or in combination, can cause heat buildup and possible tire failure.

Wear Indicators

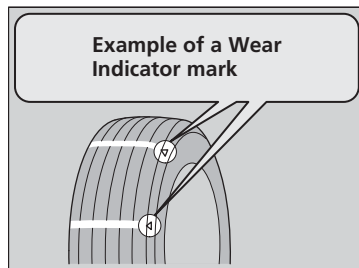

The groove where the wear indicator is located is 1/16 inch (1.6 mm) shallower than elsewhere on the tire. If the tread has worn so that the indicator is exposed, replace the tire. **Worn out tires have poor traction on wet roads.**

Tire Service Life

The life of your tires is dependent on many factors, including driving habits, road conditions, vehicle loading, inflation pressure, maintenance history, speed, and environmental conditions (even when the tires are not in use).

In addition to regular inspections and inflation pressure maintenance, it is recommended that you have annual inspections performed once the tires reach five years old. All tires, including the spare, should be removed from service after 10 years from the date of manufacture, regardless of their condition or state of wear.

▶▶ Checking Tires

Models with 215/55R17 tires

Models with 235/45R18 tires

High speed driving

We recommend that you do not drive faster than the posted speed limits and conditions allow. If you drive at sustained high speeds (over 99 mph or 160 km/h), adjust the cold tire pressures as shown below to avoid excessive heat build up and sudden tire failure.

Tire Size	215/55R17 94V 235/45R18 94V
Pressure	35 psi (240 kPa, 2.4 kgf/cm ²)

مداد خودرو فارما

تلفن شبانه روزی: ۰۲۱-۸۸۸۶۲۰۸۵

Farma5.com

Tire and Wheel Replacement

Replace your tires with radials of the same size, load range, speed rating, and maximum cold tire pressure rating (as shown on the tire's sidewall). Using tires of a different size or construction can cause the ABS and VSA® (vehicle stability assist) system to work incorrectly.

It is best to replace all four tires at the same time. If that isn't possible, replace the front or rear tires in pairs.

Make sure that the wheel's specifications match those of the original wheels.

☒ Tire and Wheel Replacement

⚠ WARNING

Installing improper tires on your vehicle can affect handling and stability. This can cause a crash in which you can be seriously hurt or killed.

Always use the size and type of tires recommended in this owner's manual.

امداد خودرو فارما

تلفن شبانه روزی: ۰۲۱-۸۸۸۶۲۰۸۵

FarmaSOS.com

Tire Rotation

Rotating tires according to the maintenance messages on the information display*/ multi-information display* helps to distribute wear more evenly and increase tire life.

■ Tires without rotation marks

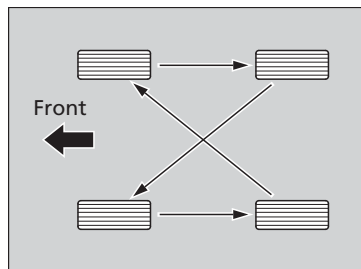

Rotate the tires as shown here.

■ Tires with rotation marks

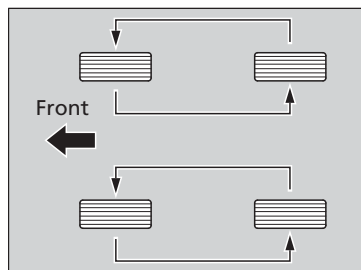

Rotate the tires as shown here. *تلفن شبانه روزی: ۰۲۱-۸۸۸۶۲۰۸۵*

► Tire Rotation

Tires with directional tread patterns should only be rotated front to back (not from one side to the other). Directional tires should be mounted with the rotation indication mark facing forward, as shown below.

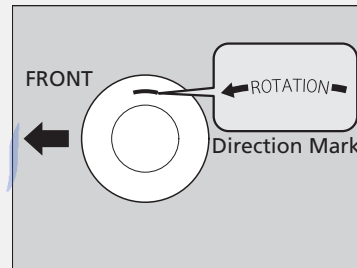

Whenever tires are rotated, you must calibrate the TPMS.

► TPMS Calibration P. 468

FarmaSOS.com

Winter Tires

If driving on snowy or frozen roads, mount all season marked **M+S** tires, snow tires, or tire chains; reduce speed; and maintain sufficient distance between vehicles when driving.

Be particularly careful when operating the steering wheel or brakes to prevent skidding.

Use tire chains, snow tires, or all season tires when necessary or according to the law.

When mounting, refer to the following points.

For winter tires:

- Select the size and load ranges that are the same as the original tires.
- Mount the tires to all four wheels.

For tire chains:

- Install them on the front tires only.
- Because your vehicle has limited tire clearance, we strongly recommend using the chains listed below:

Models with 205/65R16 tires

Cable-type: SCC Radial Chain SC1034

Models with 215/55R17 tires

Cable-type: SCC Radial Chain SC1036

Models with 235/45R18 tires

Cable-type: SCC Radial Chain SC1040

- Follow the chain manufacturer's instruction when installing. Mount them as tightly as you can.
- Check that the chains do not touch the brake lines or suspension.
- Drive slowly.

Winter Tires

⚠ WARNING

Using the wrong chains, or not properly installing chains, can damage the brake lines and cause a crash in which you can be seriously injured or killed.

Follow all instructions in this owner's manual regarding the selection and use of tire chains.

NOTICE

Traction devices that are the wrong size or improperly installed can damage your vehicle's brake lines, suspension, body, and wheels. Stop driving if they are hitting any part of the vehicle.

When tire chains are mounted, follow the chain manufacturer's instructions regarding vehicle operational limits.

If your vehicle is equipped with summer tires, be aware that these tires are not designed for winter driving conditions. For more information, contact a dealer.

Checking the Battery

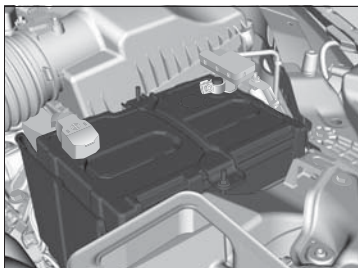

Check the battery terminals for corrosion monthly.

The battery condition is being monitored by the sensor on the negative terminal. If there is a problem with the sensor, the warning message on the information display*/multi-information display* will let you know. Have your vehicle checked by a dealer.

If your vehicle's battery is disconnected or goes dead:

- The audio system is disabled.
➤ **Reactivating the audio system** P. 177
- The clock resets.
➤ **Clock** P. 106
- The navigation system* is disabled.
➤ **Refer to the Navigation System Manual**

Charging the Battery

Disconnect both battery cables to prevent damaging your vehicle's electrical system. Always disconnect the negative (-) cable first, and reconnect it last.

ⓘ Battery

⚠ WARNING

The battery gives off explosive hydrogen gas during normal operation.

A spark or flame can cause the battery to explode with enough force to kill or seriously hurt you.

When conducting any battery maintenance, wear protective clothing and a face shield, or have a skilled technician do it.

WARNING: Battery post, terminals, and related accessories contain lead and lead compounds.
Wash your hands after handling.

When you find corrosion, clean the battery terminals by applying a baking powder and water solution. Clean the terminals with a damp towel. Cloth/towel dry the battery. Coat the terminals with grease to help prevent future corrosion.

When replacing the battery, the replacement must be of the same specifications. Please consult a dealer for more information.

Replacing the Button Battery

If the indicator does not come on when the button is pressed, replace the battery.

Master Keys with Remote Transmitter*

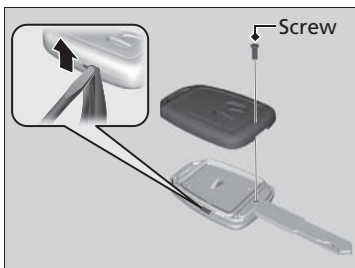

Battery type: CR1620

1. Unscrew the cover with a small Phillips-head screwdriver.
2. Open the remote transmitter.
 - ▶ Wrap the small flat-tip screwdriver with a cloth to prevent scratching the transmitter.
3. Remove the button battery with the small flat-tip screwdriver.
4. Make sure to replace the battery with the correct polarity.

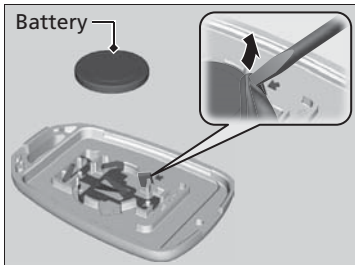

Replacing the Button Battery

NOTICE

An improperly disposed of battery can damage the environment. Always confirm local regulations for battery disposal.

Replacement batteries are commercially available or at a dealer.

FarmaSOS.com

* Not available on all models

Continued

Smart Entry Remote *



Battery type: CR2032

1. Remove the built-in key.

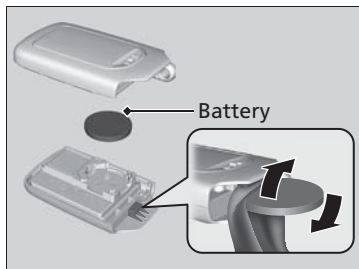

2. Remove the upper half of the cover by carefully prying on the edge with a coin.

▶ Remove carefully to avoid losing the buttons.

▶ Wrap a coin with a cloth to prevent scratching the smart entry remote.

3. Make sure to replace the battery with the correct polarity.

Dust and Pollen Filter

The heating and cooling system*/climate control system* is equipped with a dust and pollen filter that collects pollen, dust, and other debris in the air. The Maintenance Minder™ messages will let you know when to replace the filter.

We recommend that you replace the dust and pollen filter sooner when using your vehicle in areas with high concentrations of dust.

☒ Dust and Pollen Filter

If the airflow from the heating and cooling system*/climate control system* deteriorates noticeably, and the windows fog up easily, the filter may need to be replaced. Please contact a dealer for replacement.

امداد خودرو فارما

تلفن شبانه روزی: ۰۲۱-۸۸۸۶۲۰۸۵

FarmaSOS.com

* Not available on all models

Interior Care

Use a damp cloth with a mixture of mild detergent and warm water to remove dirt. Use a clean cloth to remove detergent residue.

Cleaning Seat Belts

Use a soft brush with a mixture of mild soap and warm water to clean the seat belts. Let the belts air dry. Wipe the openings of the seat belt anchors using a clean cloth.

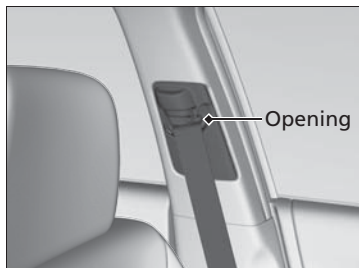

Interior Care

Do not spill liquids inside the vehicle. Electrical devices and systems may malfunction if liquids are splashed on them.

Do not use silicone based sprays on electrical devices such as audio devices and switches. Doing so may cause the items to malfunction or a fire inside the vehicle.

If a silicone based spray is inadvertently used on electrical devices, consult a dealer.

Depending on their composition, chemicals and liquid aromatics may cause discoloration, wrinkles, and cracking to resin-based parts and textiles.

Do not use alkali solvents or organic solvents such as benzene or gasoline.

After using chemicals, make sure to gently wipe them away using a dry cloth.

Do not place used cloths on top of resin based parts or textiles for long periods of time without washing.

امداد خودرو فارما

تلفن شبانه روزی: ۰۲۱-۸۸۸۶۲۰۸۵

FarmaSOS.com

Floor Mats

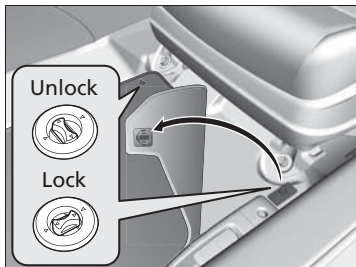

The driver's floor mat hooks over the floor anchors, which keep the mat from sliding forward. To remove a mat for cleaning, turn the anchor knobs to the unlock position. When reinstalling the mat after cleaning, turn the knobs to the lock position.

Do not put additional floor mats on top of the anchored mat.

Floor Mats

If you use any floor mats that were not originally provided with your vehicle, make sure they are designed for your specific vehicle, fit correctly, and are securely anchored by the floor anchors. Position the rear seat floor mats properly. If they are not properly positioned, the floor mats can interfere with the front seat functions.

Maintaining Genuine Leather*

Vacuum dirt and dust from the leather frequently. Pay close attention to the pleats and seams. Clean the leather with a soft cloth dampened with a 90% water and 10% neutral soap solution. Then buff it with a clean, dry cloth. Remove any dust or dirt on leather surfaces immediately.

FarmaSOS.com

* Not available on all models

Exterior Care

Dust off the vehicle body after you drive.

Regularly inspect your vehicle for scratches on painted surfaces. A scratch on a painted surface can result in body rust. If you find a scratch, promptly repair it.

■ Washing the Vehicle

Wash the vehicle regularly. Wash more frequently when driving in the following conditions:

- If driving on roads with road salt.
- If driving in coastal areas.
- If tar, soot, bird droppings, insects, or tree sap are stuck to painted surfaces.

■ Using an Automated Car Wash

Fold in the door mirrors. Make sure to follow the instructions indicated on the automated car wash.

■ Using High Pressure Cleaners

- Keep sufficient distance between the cleaning nozzle and the vehicle body.
- Take particular care around the windows. Standing too close may cause water to enter the vehicle interior. Do not spray water into the engine compartment.
- Do not spray high pressure water directly into the engine compartment. Instead, use low pressure water and a mild detergent.

►► Washing the Vehicle

Do not spray water into the air intake vents. It can cause a malfunction.

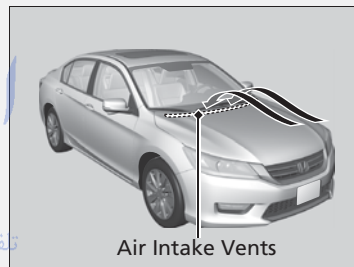

Air Intake Vents

■ Applying Wax

A good coat of automotive body wax helps protect your vehicle's paint from the elements. Wax will wear off over time and expose your vehicle's paint to the elements, so reapply as necessary.

■ Maintaining the Bumpers and Other Resin Coated Parts

If you get gasoline, oil, engine coolant, or battery fluid on resin coated parts, they may be stained or the coating may peel. Promptly wipe it away using a soft cloth and clean water.

■ Cleaning the Window

Wipe using a glass cleaner.

■ Maintaining Aluminum Wheels

Aluminum is susceptible to deterioration caused by salt and other road contaminants. Use a sponge and mild detergent to wipe away promptly. Be careful not to use harsh chemicals (including some commercial wheel cleaners) or a stiff brush. They can damage the clear coat of the aluminum alloy wheels that helps keep the aluminum from corroding and tarnishing.

▣ Applying Wax

NOTICE

Chemical solvents and strong cleaners can damage the paint, metal, and plastic on your vehicle. Wipe away spills immediately.

▣ Maintaining the Bumpers and Other Resin Coated Parts

Ask a dealer about the correct coating material when you want to repair the painted surface of the parts made of resin.

▣ Cleaning the Window

Wires are mounted to the inside of the rear window. Wipe along the same direction as the wires with a soft cloth so as not to damage them.

■ Fogged Exterior Light Lenses

The inside lenses of exterior lights (headlights, brake lights, etc.) may fog temporarily if you have driven in the rain, or after the vehicle has been run through a car wash. Dew condensation also may build up inside the lenses when there is a significant enough difference between the ambient and inside lens temperatures (similar to vehicle windows fogging up in rainy conditions). These conditions are natural processes, not structural design problems in the exterior lights.

Lens design characteristics may result in moisture developing on the light lens frame surfaces. This also is not a malfunction.

However, if you see large amounts of water accumulation, or large water drops building up inside the lenses, have your vehicle inspected by a dealer.

تلفن شبانه روزی: ۰۲۱-۸۸۸۶۲۰۸۵

FarmaSOS.com

Handling the Unexpected

This chapter explains how to handle unexpected troubles.

امداد خودرو فارما

تلفن شبانه روزی: ۰۲۱-۸۸۸۶۲۰۸۵

Tools	
Types of Tools	542
If a Tire Goes Flat	
Changing a Flat Tire	543
Engine Does Not Start	
Checking the Engine	549
If the Smart Entry Remote Battery is Weak	550
Emergency Engine Stop	551
Jump Starting	552
Shift Lever Does Not Move	555

Overheating	
How to Handle Overheating	556
Indicator, Coming On/Blinking	
If the Low Oil Pressure Indicator Comes On	558
If the Charging System Indicator Comes On	558
If the Malfunction Indicator Lamp Comes On or Blinks	559
If the Brake System Indicator (Red) Comes On	560

If the Electric Power Steering (EPS) System Indicator Comes On	560
If the Low Tire Pressure/TPMS Indicator Comes On or Blinks	561
Fuses	
Fuse Locations	562
Inspecting and Changing Fuses	564
Emergency Towing	565

Types of Tools

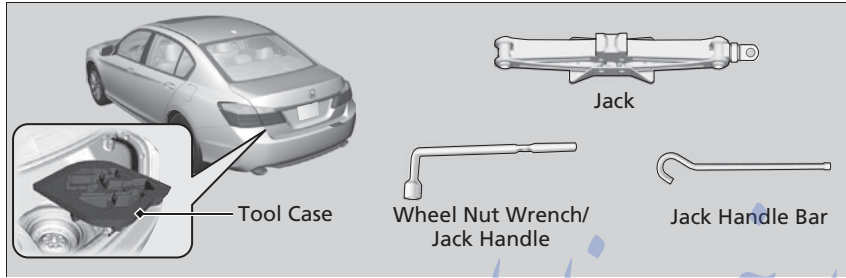

Types of Tools

The tools are stored in the trunk.

امداد خودرو فارما

تلفن شبانه روزی: ۰۲۱-۸۸۸۶۲۰۸۵

FarmaSOS.com

Changing a Flat Tire

If a tire goes flat while driving, grasp the steering wheel firmly, and brake gradually to reduce speed. Then, stop in a safe place. Replace the flat tire with a compact spare tire. Go to a dealer as soon as possible to have the full-size tire repaired or replaced.

1. Park the vehicle on firm, level, and non-slippery surface, and apply the parking brake.

Automatic transmission/CVT models

2. Move the shift lever to **P**.

Manual transmission models

2. Move the shift lever to **R**.

All models

3. Turn on the hazard warning lights and turn the ignition switch to LOCK **0**^{*1}.

*1: Models with the smart entry system have an **ENGINE START/STOP** button instead of an ignition switch.

Changing a Flat Tire

Periodically check the tire pressure of the compact spare. It should be set to the specified pressure.
Specified Pressure: 60 psi (420 kPa, 4.2 kgf/cm²)

When driving with the compact spare tire, keep the vehicle speed under 50 mph (80 km/h). Replace with a full-size tire as soon as possible.

The compact spare tire and wheel in your vehicle are specifically for this model. Do not use them with another vehicle. Do not use another type of compact spare tire or wheel with your vehicle.

Do not mount tire chains on a compact spare tire. If a chain-mounted front tire goes flat, remove one of the full-size rear tires and replace it with the compact spare tire. Remove the flat front tire and replace it with the full-size tire that was removed from the rear. Mount the tire chains on the front tire.

FarmaSOS.com

Continued

Getting Ready to Replace the Flat Tire

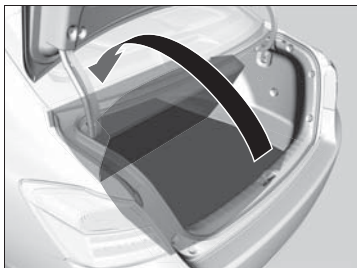

1. Open the trunk floor lid.

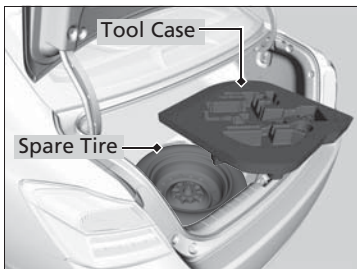

2. Take the tool case out of the trunk. Take the jack and wheel nut wrench out of the tool case.

3. Unscrew the wing bolt, and remove the spacer cone. Then, remove the spare tire.

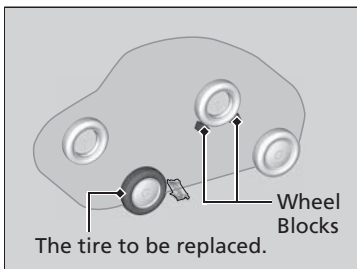

4. Place a wheel block or rock in front and rear of the wheel diagonal to the flat tire.

FarmaSOS.com

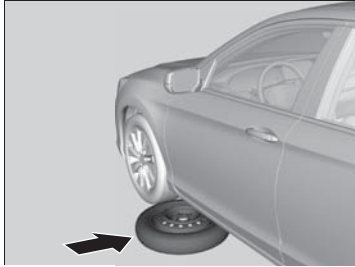

5. Place the compact spare tire (wheel side up) under the vehicle body, near the tire that needs to be replaced.

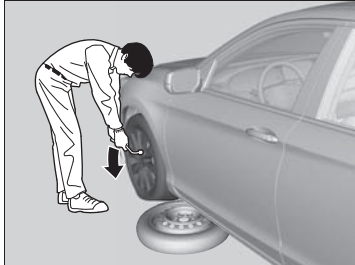

6. Loosen each wheel nut about one turn using the wheel nut wrench.

امداد نوروز فارما

تلفن شبانه روزی: ۰۲۱-۸۸۸۶۲۰۸۵

FarmaSOS.com

How to Set Up the Jack

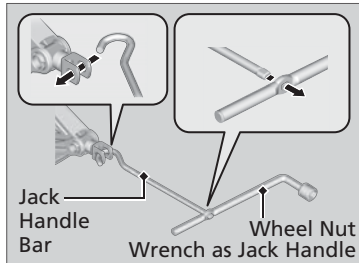
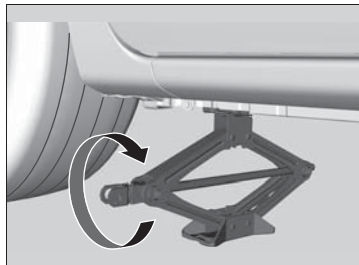
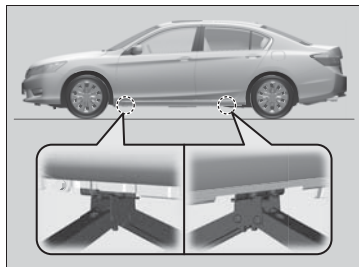

1. Place the jack under the jacking point closest to the tire to be changed.

2. Turn the end bracket clockwise as shown in the image until the top of the jack contacts the jacking point.

► Make sure that the jacking point tab is resting in the jack notch.

3. Raise the vehicle, using the jack handle bar and the jack handle, until the tire is off the ground.

How to Set Up the Jack

⚠ WARNING

The vehicle can easily roll off the jack, seriously injuring anyone underneath.

Follow the directions for changing a tire exactly, and never get under the vehicle when it is supported only by the jack.

Do not use the jack with people or luggage in the vehicle.

Use the jack provided in your vehicle. Other jacks may not support the weight ("load") or may not fit the jacking point.

The following instructions must be followed to use the jack safely:

- Do not use while the engine is running.
- Use only where the ground is firm and level.
- Use only at the jacking points.
- Do not get in the vehicle while using the jack.
- Do not put anything on top of or underneath the jack.

Replacing the Flat Tire



1. Remove the wheel nuts and flat tire.

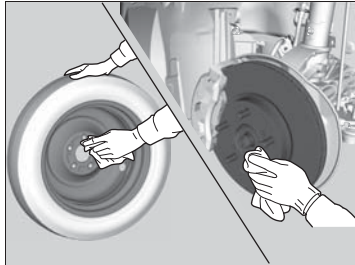

2. Wipe the mounting surfaces of the wheel with a clean cloth.

3. Mount the compact spare tire.

4. Screw the wheel nuts until they touch the lips around the mounting holes, then stop rotating.

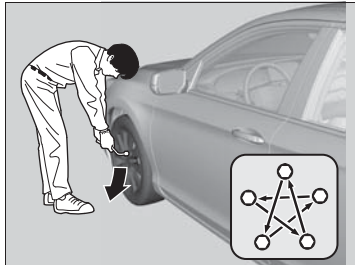

5. Lower the vehicle and remove the jack.

Tighten the wheel nuts in the order indicated in the image. Go around, tightening the nuts, two to three times in this order.

Wheel nut torque:

80 lbf-ft (108 N-m, 11 kgf-m)

Replacing the Flat Tire

Do not over tighten the wheel nuts by applying extra torque using your foot or a pipe.

امداد خودرو فارما

تلفن شبانه روزی: 021-88888888

FarmaSOS.com

■ Storing the Flat Tire

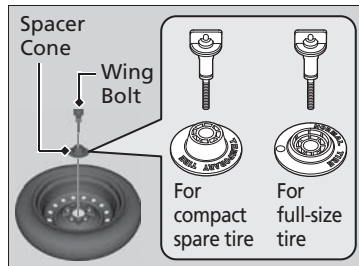

1. Remove the center cap.
2. Place the flat tire face down in the spare tire well.
3. Remove the spacer cone from the wing bolt, flip it over, and insert it back on the bolt. Secure the flat tire with the wing bolt.
4. Securely put the jack and wheel nut wrench back in the tool case. Store the case in the trunk.

■ TPMS and the Spare Tire

If you replace a flat tire with the spare tire, the low tire pressure/TPMS indicator comes on while you are driving. After driving for a few miles (kilometers), the indicator will start blinking for a short time and then stay on. **Tire Pressures Low** appears on the multi-information display*, but this is normal.

Calibrate the TPMS when you replace the tire with a specified regular tire.

📖 **TPMS Calibration** P. 468

▶▶ Storing the Flat Tire

⚠ **WARNING**

Loose items can fly around the interior in a crash and can seriously injure the occupants.

Store the wheel, jack, and tools securely before driving.

Checking the Engine

If the engine does not start, check the starter.

☞ Checking the Engine

If you must start the vehicle immediately, use an assisting vehicle to jump start it.

☞ **Jump Starting** P. 552

Starter condition	Checklist
<p>Starter doesn't turn or turns over slowly.</p> <p>The battery may be dead. Check each of the items on the right and respond accordingly.</p>	<p>Models with multi-information display</p> <p>Check for a message on the multi-information display.</p> <ul style="list-style-type: none">• If the To Start, Hold Remote Near Start Button message appears<ul style="list-style-type: none">☞ If the Smart Entry Remote Battery is Weak P. 550▶ Make sure the smart entry remote is in its operating range.<ul style="list-style-type: none">☞ ENGINE START/STOP Button Operating Range P. 132
<p>The starter turns over normally but the engine doesn't start.</p> <p>There may be a problem with the fuse. Check each of the items on the right and respond accordingly.</p>	<p>Check brightness of the interior lights.</p> <p>Turn on the interior lights and check the brightness.</p> <ul style="list-style-type: none">• If the interior lights are dim or do not come on at all<ul style="list-style-type: none">☞ Battery P. 532• If the interior lights come on normally<ul style="list-style-type: none">☞ Fuses P. 562
<p>Review the engine start procedure.</p> <p>Follow its instructions, and try to start the engine again.</p>	<p>☞ Starting the Engine P. 425, 427</p> <p>Check the immobilizer system indicator.</p> <p>When the immobilizer system indicator is blinking, the engine cannot be started.</p> <p>☞ Immobilizer System P. 124</p>
<p>Check the fuel level.</p> <p>There should be enough fuel in the tank.</p>	<p>☞ Fuel Gauge P. 89</p>
<p>Check the fuse.</p> <p>Check all fuses, or have the vehicle checked by a dealer.</p>	<p>☞ Inspecting and Changing Fuses P. 564</p>
<p>If the problem continues:</p>	<p>☞ Emergency Towing P. 565</p>

Models with smart entry system

If the Smart Entry Remote Battery is Weak

If the beeper sounds, the indicator on the **ENGINE START/STOP** button flashes, and the engine won't start.

Models with multi-information display

The **To Start, Hold Remote Near Start Button** message appears on the multi-information display.

All models

Start the engine as follows.

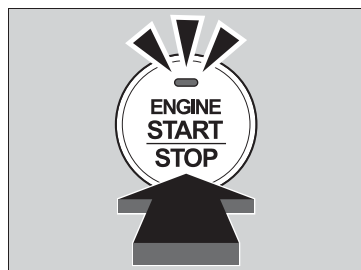
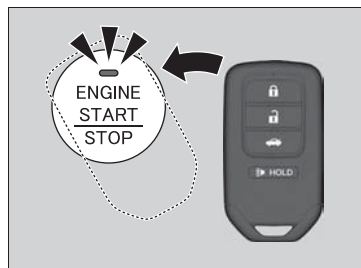

1. Touch the center of the **ENGINE START/STOP** button with the **H** logo on the smart entry remote while the indicator on the **ENGINE START/STOP** button is flashing.

The buttons on the smart entry remote should be facing you.

- The indicator flashes for about 30 seconds.

2. Depress the brake pedal (automatic transmission) or clutch pedal (manual transmission) and press the **ENGINE START/STOP** button within 10 seconds after the beeper sounds and the indicator stays on.

- If you don't depress the pedal, the mode will change to ACCESSORY.

Models with smart entry system

Emergency Engine Stop

The **ENGINE START/STOP** button may be used to stop the engine due to an emergency situation even while driving. If you must stop the engine, do either of the following operations:

- Press and hold the **ENGINE START/STOP** button for about two seconds.
- Firmly press the **ENGINE START/STOP** button twice.

The steering wheel will not lock. However, because turning off the engine disables the power assist the engine provides to the steering and braking systems, it will require significantly more physical effort and time to steer and slow the vehicle. Use both feet on the brake pedal to slow down the vehicle and stop immediately in a safe place. With manual transmission models you can also downshift the transmission to utilize engine braking.

U.S. automatic transmission/CVT models

The power mode is in ACCESSORY when the engine is stopped.

To change the mode to VEHICLE OFF, move the shift lever to **P** after the vehicle comes to a complete stop.

Canadian automatic transmission/CVT models

Then press the **ENGINE START/STOP** button twice without depressing the brake pedal.

Manual transmission models

The power mode changes to VEHICLE OFF.

Emergency Engine Stop

Do not press the button while driving unless it is absolutely necessary for the engine to be switched off.

Jump Starting Procedure

Turn off the power to electric devices, such as audio and lights. Turn off the engine, then open the hood.

4-cylinder models

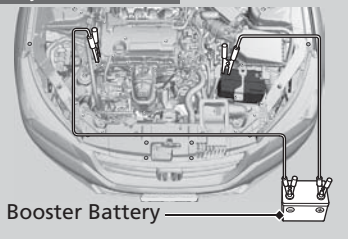

6-cylinder models

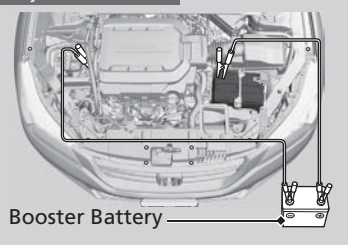

1. Connect the first jumper cable to your vehicle's battery \oplus terminal.
2. Connect the other end of the first jumper cable to the booster battery \oplus terminal.
 - ▶ Use a 12-volt booster battery only.
 - ▶ When using an automotive battery charger to boost your 12-volt battery, select a lower charging voltage than 15-volt. Check the charger manual for the proper setting.
3. Connect the second jumper cable to the booster battery \ominus terminal.

Jump Starting

⚠ WARNING

A battery can explode if you do not follow the correct procedure, seriously injuring anyone nearby.

Keep all sparks, open flames, and smoking materials away from the battery.

Securely attach the jumper cables clips so that they do not come off when the engine vibrates. Also be careful not to tangle the jumper cables or allow the cable ends to touch each other while attaching or detaching the jumper cables.

FarmaSOS.com

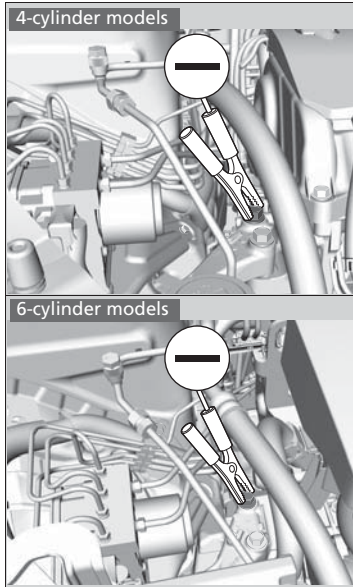

4. Connect the other end of the second jumper cable to the engine mounting bolt as shown. Do not connect this jumper cable to any other part.
5. If your vehicle is connected to another vehicle, start the assisting vehicle's engine and increase its rpm slightly.
6. Attempt to start your vehicle's engine. If it turns over slowly, check that the jumper cables have good metal-to-metal contact.

Jump Starting

Battery performance degrades in cold conditions and may prevent the engine from starting.

امداد خودرو فارما

تلفن شبانه روزی: ۰۲۱-۸۸۸۶۲۰۸۵

FarmaSOS.com

Continued

What to Do After the Engine Starts

Once your vehicle's engine has started, remove the jumper cables in the following order.

1. Disconnect the jumper cable from your vehicle's ground.
2. Disconnect the other end of the jumper cable from the booster battery \ominus terminal.
3. Disconnect the jumper cable from your vehicle's battery \oplus terminal.
4. Disconnect the other end of the jumper cable from the booster battery \oplus terminal.

Have your vehicle inspected by a nearby service station or a dealer.

تلفن شبانه روزی: ۰۲۱-۸۸۸۶۲۰۸۵

FarmaSOS.com

Shift Lever Does Not Move

Automatic transmission/CVT models

Follow the procedure below if you cannot move the shift lever out of the **P** position.

Releasing the Lock

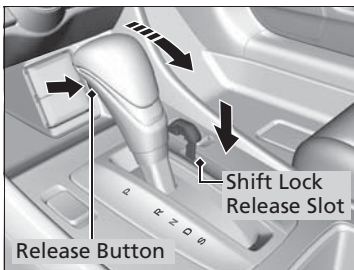
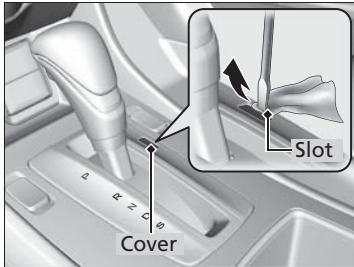

1. Set the parking brake.

Models without smart entry system

2. Remove the key from the ignition switch.

Models with smart entry system

2. Remove the built-in key from the smart entry remote.

All models

3. Wrap a cloth around the tip of a small flat-tip screwdriver. Put it into the shift lock release slot as shown in the image, and remove the cover.
4. Insert the key into the shift lock release slot.
5. While pushing the key down, press the shift lever release button and place the shift lever into **N**.
 - ▶ The lock is now released. Have the shift lever checked by a dealer as soon as possible.

How to Handle Overheating

Overheating symptoms are as follows:

- The temperature gauge needle is at the **H** mark or the engine suddenly loses power.
- Steam or spray comes out of the engine compartment.

■ First thing to do

1. Immediately park the vehicle in a safe place.
2. Turn off all accessories and turn on the hazard warning lights.
 - ▶ **No steam or spray present:** Keep the engine running and open the hood.
 - ▶ **Steam or spray is present:** Turn off the engine and wait until it subsides. Then open the hood.

How to Handle Overheating

⚠ WARNING

Steam and spray from an overheated engine can seriously scald you.

Do not open the hood if steam is coming out.

NOTICE

Continuing to drive with the temperature gauge needle at the **H** mark may damage the engine.

■ Next thing to do

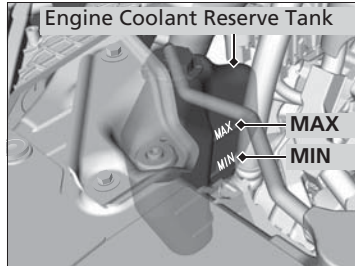

1. Check that the cooling fan is operating and stop the engine once the temperature gauge needle comes down.
 - ▶ If the cooling fan is not operating, immediately stop the engine.
2. Once the engine has cooled down, inspect the coolant level and check the cooling system components for leaks.
 - ▶ If the coolant level in the engine coolant reserve tank is low, add coolant until it reaches the **MAX** mark.
 - ▶ If there is no coolant in the reserve tank, check that the radiator is cool. Cover the radiator cap with a heavy cloth and open the cap. If necessary, add coolant up to the base of the filler neck, and put the cap back on.

■ Last thing to do

Once the engine has cooled sufficiently, restart it and check the temperature gauge. If the temperature gauge needle has gone down, resume driving. If it has not gone down, contact a dealer for repairs.

How to Handle Overheating

⚠ WARNING

Removing the radiator cap while the engine is hot can cause the coolant to spray out, seriously scalding you.

Always let the engine and radiator cool down before removing the radiator cap.

If the coolant is leaking, contact a dealer for repairs.

Use water as an emergency/temporary measure only. Have a dealer flush the system with proper antifreeze as soon as possible.

FarmaSOS.com

If the Low Oil Pressure Indicator Comes On



■ Reasons for the indicator to come on

Comes on when the engine oil pressure is low.

■ What to do as soon as the indicator comes on

1. Immediately park the vehicle in a safe place.
2. If necessary, turn the hazard warning lights on.

■ What to do after parking the vehicle

1. Stop the engine and let it sit for about three minute.
2. Open the hood and check the oil level.
 - ▶ Add oil as necessary.
3. Start the engine and check the low oil pressure indicator.
 - ▶ The indicator goes off: Start driving again.
 - ▶ The indicator does not go off within 10 seconds: Stop the engine and contact a dealer for repairs immediately.

▶ If the Low Oil Pressure Indicator Comes On

NOTICE

Running the engine with low oil pressure can cause serious mechanical damage almost immediately.

If the Charging System Indicator Comes On



■ Reasons for the indicator to come on

Comes on when the battery is not being charged.

■ What to do when the indicator comes on

Turn off the heating and cooling system /climate control system , rear defogger, and other electrical systems, and immediately contact a dealer for repairs.

▶ If the Charging System Indicator Comes On

If you need to stop temporarily, do not turn off the engine. Restarting the engine may rapidly discharge the battery.

If the Malfunction Indicator Lamp Comes On or Blinks



■ Reasons for the indicator lamp to come on or blink

- Comes on if there is a problem with the engine emissions control system, or the fuel fill cap is missing, or loose.
- Blinks when engine misfiring is detected.

■ What to do when the indicator lamp comes on

Avoid high speeds and immediately get your vehicle inspected at a dealer.

■ What to do when the indicator lamp blinks

Park the vehicle in a safe place with no flammable items and wait at least 10 minutes or more with the engine stopped until it cools.

■ Check/Tighten Fuel Cap Message

■ The message appears on when:

An evaporative system leak is detected. This may be caused by the fuel fill cap being loose or not being installed.

■ What to do when the message appears:

1. Stop the engine.
2. Check if the fuel fill cap is fully installed.
 - ▶ If not, loosen the cap, and then retighten it until it clicks at least once.
3. Drive for several days of normal driving.
 - ▶ The message should go off.

■ When the malfunction indicator lamp comes on

The malfunction indicator lamp comes on if the system continues to detect a leak of gasoline vapor. If this happens, check the fuel fill cap using the procedures described above.

▶▶ If the Malfunction Indicator Lamp Comes On or Blinks

NOTICE

If you drive with the malfunction indicator lamp on, the emissions control system and the engine could be damaged.

If the malfunction indicator lamp blinks again when restarting the engine, drive to the nearest dealer at 31 mph (50 km/h) or less. Have your vehicle inspected.

If the Brake System Indicator (Red) Comes On

U.S.



■ Reasons for the indicator to come on

- The brake fluid is low.
- There is a malfunction in the brake system.

■ What to do when the indicator comes on while driving

Press the brake pedal lightly to check pedal pressure.

- If normal, check the brake fluid level the next time you stop.
- If abnormal, take immediate action. If necessary, downshift the transmission to slow the vehicle using engine braking.

Canada



If the Electric Power Steering (EPS) System Indicator Comes On



■ Reasons for the indicator to come on

- Comes on if there is a problem with the EPS system.
- If you depress the accelerator pedal repeatedly to increase the engine speed while the engine is idling, the indicator comes on, and sometimes the steering wheel becomes harder to operate.

■ What to do when the indicator comes on

Stop the vehicle in a safe place and restart the engine.

If the indicator comes on and stays on, immediately have your vehicle inspected by a dealer.

▶▶ If the Brake System Indicator (Red) Comes On

Have your vehicle repaired immediately.

It is dangerous to drive with low brake fluid. If there is no resistance from the brake pedal, stop immediately in a safe place. If necessary, downshift the gears.

If the brake system indicator and **ABS** indicator come on simultaneously, the electronic brake distribution system is not working. This can result in vehicle instability under sudden braking.

Have your vehicle inspected by a dealer immediately.

If the Low Tire Pressure/TPMS Indicator Comes On or Blinks



■ Reasons for the indicator to come on or blink

A tire pressure is significantly low, or the TPMS has not been calibrated. If there is a problem with the TPMS or the compact spare tire is installed, the indicator blinks for about one minute, and then stays on.

■ What to do when the indicator comes on

Drive carefully and avoid abrupt cornering and hard braking. Stop your vehicle in a safe place. Check the tire pressure and adjust the pressure to the specified level. The specified tire pressure is on a label on the driver side doorjamb.

- ▶ Calibrate the TPMS after the tire pressure is adjusted.

■ What to do when the indicator blinks, then remains on

Have the tire inspected by a dealer as soon as possible. If the compact spare tire causes the indicator to blink, change the tire to a full-size tire. The indicator goes off after driving for a few miles (kilometers).

- ▶ Calibrate the TPMS after a full-size tire is reinstalled.

▶▶ If the Low Tire Pressure/TPMS Indicator Comes On or Blinks

NOTICE

Driving on an extremely underinflated tire can cause it to overheat. An overheated tire can fail. Always inflate your tires to the prescribed level.

FarmaSOS.com

Fuse Locations

If any electrical devices are not working, turn the ignition switch to LOCK [0]^{*1} and check to see if any applicable fuse is blown.

Engine Compartment Fuse Box

Located near the brake fluid reservoir. Push the tabs to open the box.

Fuse locations are shown on the fuse box cover. Locate the fuse in question by the fuse number and box cover number.

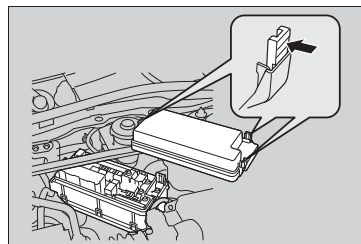

Circuit protected and fuse rating

	Circuit Protected	Amps
1	Battery	125 A
	EPS	70 A
	Fuse Box Main 1	(60 A)
	Fuse Box Option 1	(40 A)
2	–	–
	–	–
	ABS/VSA FSR	40 A
	ABS/VSA Motor	30 A

	Circuit Protected	Amps
3	–	–
	–	–
	–	–
	–	–
4	Front Fog Light*	(15 A)
5	Horn	10 A
6	Stop Light	10 A
7	FI Sub	15 A
8	DRL	(7.5 A)
9	IG Coil	15 A
10	Injector* ²	20 A
11	Hazard	15 A
	Fuse Box Main 2	60 A
	Fuse Box Option 2	(40 A)
	IG Main 1	50 A
		30 A ^{*4}
	IG Main 2 ^{*4}	30 A
12	Sub Fan Motor	20 A ^{*2}
		30 A ^{*3}
	Headlight Low Beam Main	30 A
	Fuse Box	30 A
	Wiper Motor	30 A
	Main Fan Motor	30 A
	Starter Motor ^{*4}	30 A
13	Rear Defogger	40 A
14	Heater Motor	40 A
15	FI Main	15 A

	Circuit Protected	Amps
16	Heated Door Mirror*	(10 A)
17	MG Clutch	7.5 A
18	DBW	15 A
19	Small Light	20 A
20	Interior Light	7.5 A
21	Back Up	10 A
22	Audio	10 A
23	Fan Timer	7.5 A
24	Right Headlight Low Beam	10 A
25	Left Headlight Low Beam	10 A
26	–	–

*1: Models with the smart entry system have an **ENGINE START/STOP** button instead of an ignition switch.

*2: 4-cylinder models

*3: 6-cylinder models

*4: Models with smart entry system

Interior Fuse Box

Located under the dashboard.

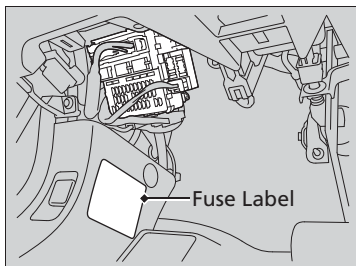

Fuse locations are shown on the label on the side panel.

Locate the fuse in question by the fuse number and label number.

■ Circuit protected and fuse rating

	Circuit Protected	Amps
1	A/C	7.5 A
2	DRL	7.5 A
3	–	–
4	–	–
5	Meter	7.5 A
6	SRS	7.5 A
7	Option*	(7.5 A)
8	MISS SOL	10 A
9	Fuel Pump	20 A

* Not available on all models

	Circuit Protected	Amps
10	ABS/VSA	7.5 A
11	–	–
12	Front Wiper	7.5 A
13	ACG	15 A
14	Rear Accessory Power Socket (Console Compartment)	(20 A)
15	Driver's Power Seat Reclining*	(20 A)
16	Moonroof*	(20 A)
17	Front Seat Heaters*	(20 A)
18	–	–
19	Passenger Side Door Unlock	10 A
20	Driver Side Rear Door Unlock	10 A
21	Driver's Door Lock	10 A
22	Passenger Side Door Lock	10 A
23	Driver's Door Unlock	10 A
24	SRS	10 A
25	Illumination	10 A
26	Key Lock	7.5 A
27	Parking Lights	10 A
28	Lumbar Support*	(10 A)
29	Right Headlight High Beam	10 A
30	Washer	15 A
31	SMART*	(10 A)
32	Driver's Power Window	20 A

	Circuit Protected	Amps
33	Front Passenger's Power Window	20 A
34	Rear Driver Side Power Window	20 A
35	Rear Passenger Side Power Window	20 A
36	Driver's Power Seat Sliding*	(20 A)
37	ACCESSORY	7.5 A
38	–	–
39	Left Headlight High Beam	10 A
40	Accessory Power Socket (Console Panel)	20 A
41	Driver Side Rear Door Lock	10 A
42	Door Lock	20 A
a	Audio*	(7.5 A)
b	ACM*	(20 A)
c	Rear Seat Heaters*	(15 A)
d	Premium Amp*	(20 A)
e	–	–
f	–	–
g	Passenger's Power Seat Reclining*	(20 A)
h	Passenger's Power Seat Sliding*	(20 A)

Inspecting and Changing Fuses

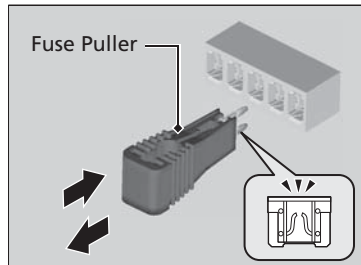
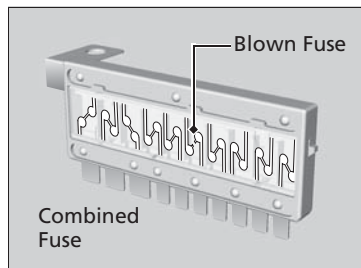

1. Turn the ignition switch to LOCK [0]*1. Turn headlights and all accessories off.
2. Remove the fuse box cover.
3. Check the large fuse in the engine compartment.
 - If the fuse is blown, use a Phillips-head screwdriver to remove the screw and replace it with a new one.
4. Inspect the small fuses in the engine compartment and the vehicle interior.
 - If there is a burned out fuse, remove it with the fuse puller and replace it with a new one.

► Inspecting and Changing Fuses

NOTICE

Replacing a fuse with one that has a higher rating greatly increases the chances of damaging the electrical system.

Replace fuse with a spare fuse of the same specified amperage.

Confirm the specified amperage using the charts on P. 562 to 563.

There is a fuse puller on the back of the engine compartment fuse box cover.

تلفن شبانه روزی: ۰۲۱-۸۸۸۶۲۰۸۵

FarmaSOS.com

* 1: Models with the smart entry system have an **ENGINE START/STOP** button instead of an ignition switch.

Call a professional towing service if you need to tow your vehicle.

■ Flat bed equipment

The operator loads your vehicle on the back of a truck.

This is the best way to transport your vehicle.

■ Wheel lift equipment

The tow truck uses two pivoting arms that go under the front tires and lift them off the ground. The rear tires remain on the ground. **This is an acceptable way to tow your vehicle.**

Emergency Towing

NOTICE

Trying to lift or tow your vehicle by the bumpers will cause serious damage. The bumpers are not designed to support the vehicle's weight.

NOTICE

Improper towing such as towing behind a motorhome or other motor vehicle can damage the transmission.

Never tow your vehicle with just a rope or chain. It is very dangerous since ropes or chains may shift from side to side or break.

امداد خودرو فارما

تلفن شبانه روزی: ۰۲۱-۸۸۸۶۲۰۸۵

FarmaSOS.com

امداد خودرو فارما

تلفن شبانه روزی: ۰۲۱-۸۸۸۶۲۰۸۵

FarmaSOS.com

Information

This chapter includes your vehicle's specifications, locations of identification numbers, and other information required by regulation.

امداد خودرو فارما

تلفن شبانه روزی: ۰۲۱-۸۸۸۶۲۰۸۵

Specifications	568
Identification Numbers	
Vehicle Identification Number (VIN), Engine Number and Transmission Number	572
Devices that Emit Radio Waves	573
Reporting Safety Defects	574

Emissions Testing	
Testing of Readiness Codes	575
Warranty Coverages	577
Authorized Manuals	579
Customer Service Information	580

4-cylinder models

Vehicle Specifications

Model	Honda Accord Sedan	
No. of Passengers:		
Front	2	
Rear	3	
Total	5	
Weights:		
Gross Vehicle Weight Rating	U.S.: 4,200 lbs (1,905 kg) ^{*1} 4,321 lbs (1,960 kg) ^{*2} Canada: 1,930 kg ^{*1} 1,980 kg ^{*2}	
Gross Axle Weight Rating (Front)	U.S.: 2,249 lbs (1,020 kg) ^{*1} 2,315 lbs (1,050 kg) ^{*2} Canada: 1,030 kg ^{*1} 1,065 kg ^{*2}	
Gross Axle Weight Rating (Rear)	U.S.: 2,006 lbs (910 kg) ^{*1} 2,050 lbs (930 kg) ^{*2} Canada: 910 kg ^{*1} 930 kg ^{*2}	
Air Conditioning:		
Refrigerant Type	HFC-134a (R-134a)	
Charge Quantity	15.0 – 16.8 oz (425 – 475 g)	
Lubricant Type	ND-OIL 8	

^{*1}: LX models

^{*2}: Except LX models

Engine Specifications

Displacement	144 cu-in (2,356 cm ³)	
Spark Plugs	NGK	DILKAR7G11GS
		DILKAR7H11GS
	DENSO	DXE22HQR-D11S

Fuel

Fuel Type	Unleaded gasoline, Pump octane number of 87 or higher
Fuel Tank Capacity	17.2 US gal (65 ℓ)

Washer Fluid

Tank Capacity	U.S.: 2.6 US qt (2.5 ℓ) Canada: 5.12 US qt (4.85 ℓ)
---------------	--

امداد خودرو فارما

تلفن شبانه روزی: ۰۲۱-۸۸۸۶۲۰۸۵

FarmaSOS.com

Light Bulbs

Headlights (Low Beam)	55W (H11) [*] LED [*]
Headlights (High Beam)	60W (HB3)
Fog Lights [*]	35W (H8)
Parking Lights [*]	5W
Parking/Daytime Running Lights [*]	LED
Front Turn Signal/Side Marker Lights	27/8 W (Amber)
Side Turn Signal Lights (on Door Mirrors) [*]	LED
Brake/Taillights/Rear Side Marker Lights [*]	21/5W
Brake/Taillights [*]	LED
Rear Side Marker Lights [*]	LED
Taillights	3CP [*] LED [*]
Back-Up Lights	16W
Rear Turn Signal Lights	21W (Amber)
High-Mount Brake Light	LED
Rear License Plate Lights	5W
Trunk Light	5W
Interior Lights	
Map Lights	8W
Ceiling Light	8W
Vanity Mirror Lights [*]	1.4W
Courtesy Lights [*]	2CP

■ Brake/Clutch Fluid

Specified	Honda Heavy Duty Brake Fluid DOT 3	
-----------	------------------------------------	--

■ Continuously Variable Transmission (CVT) Fluid

Specified	HCF-2	
Capacity	Change	3.9 US qt (3.7 ℓ)

■ Manual Transmission Fluid

Specified	Honda Manual Transmission Fluid	
Capacity	Change	2.0 US qt (1.9 ℓ)

■ Engine Oil

Recommended	-Genuine Honda Motor Oil 0W-20	
	-API Premium-grade 0W-20 detergent oil	
Capacity	Change	4.2 US qt (4.0 ℓ)
	Change including filter	4.4 US qt (4.2 ℓ)

■ Engine Coolant

Specified	Honda Long-Life Antifreeze/Coolant Type2	
Ratio	50/50 with distilled water	
Capacity	1.65 US gal (6.23 ℓ)*1	
	1.65 US gal (6.25 ℓ)*2 (change including the remaining)	
	0.17 US gal (0.64 ℓ) in the reserve tank	

*1: Continuously variable transmission (CVT) models

*2: Manual transmission models

تلفن شبانه روزی: ۰۲۱-۸۸۸۶۲۰۸۵

FarmaSOS.com

■ Tire

Regular	Size	205/65R16 95H ³ 215/55R17 94V ⁴ 235/45R18 94V ⁵
	Pressure psi (kPa [kgf/cm ²])	33 (230 [2.3]) ³ 33 (225 [2.3]) ^{4, 5}
	Front	32 (220 [2.2]) ^{3, 5} 33 (225 [2.3]) ⁴
Compact Spare	Size	T125/80D16 97M
	Pressure psi (kPa [kgf/cm ²])	60 (420 [4.2])
Wheel Size	Regular	16 x 7J ³ 17 x 7 1/2J ⁴ 18 x 8J ⁵
	Compact Spare	16 x 4T

*3: U.S. LX models

*4: U.S. EX, EX-L models and Canadian LX, EX, EX-L models

*5: U.S. Sport models and Canadian Sport, Touring models

6-cylinder models

■ Vehicle Specifications

Model	Honda Accord Sedan
No. of Passengers:	
Front	2
Rear	3
Total	5
Weights:	
Gross Vehicle	U.S.: 4,542 lbs (2,060 kg)
Weight Rating	Canada: 2,060 kg
Gross Axle Weight	
Rating (Front)	U.S.: 2,491 lbs (1,130 kg)
	Canada: 1,130 kg
Gross Axle Weight	
Rating (Rear)	U.S.: 2,072 lbs (940 kg)
	Canada: 940 kg
Air Conditioning:	
Refrigerant Type	HFC-134a (R-134a)
Charge Quantity	15.0 – 16.8 oz (425 – 475 g)
Lubricant Type	ND-OIL 8

■ Engine Specifications

Displacement	212 cu-in (3,471 cm ³)	
Spark Plugs	NGK	ILZKR7B11
	DENSO	SXU22HCR11

■ Fuel

Fuel:	Unleaded gasoline, Pump octane number
Type	of 87 or higher
Fuel Tank Capacity	17.2 US gal (65 ℓ)

■ Washer Fluid

Tank Capacity	U.S.: 2.6 US qt (2.5 ℓ)
	Canada: 5.12 US qt (4.85 ℓ)

امداد خودرو فارما

تلفن شبانه روزی: ۰۲۱-۸۸۸۶۲۰۸۵

FarmaSOS.com

■ Light Bulbs

Headlights (Low Beam)	55W (H11)* LED*
Headlights (High Beam)	60W (HB3)
Fog Lights	35W (H8)
Parking Lights*	5W
Parking/Daytime Running Lights*	LED
Front Turn Signal/Side Marker Lights	27/8 W (Amber)
Side Turn Signal Lights (on Door Mirrors)	LED
Brake/Taillights	LED
Rear Side Marker Lights	LED
Taillights	LED
Back-Up Lights	16W
Rear Turn Signal Lights	21W (Amber)
High-Mount Brake Light	LED
Rear License Plate Lights	5W
Trunk Light	5W
Interior Lights	
Map Lights	8W
Ceiling Light	8W
Vanity Mirror Lights	1.4W
Courtesy Lights	2CP

■ Brake Fluid

Specified	Honda Heavy Duty Brake Fluid DOT 3
-----------	------------------------------------

■ Automatic Transmission Fluid

Specified	Honda ATF DW-1 (automatic transmission fluid)
Capacity	Change 3.3 US qt (3.1 ℓ)

■ Engine Oil

Recommended	-Genuine Honda Motor Oil 0W-20
	-API Premium-grade 0W-20 detergent oil
Change	4.2 US qt (4.0 ℓ)
	Change including filter
Capacity	4.5 US qt (4.3 ℓ)

■ Engine Coolant

Specified	Honda Long-Life Antifreeze/Coolant Type2
Ratio	50/50 with distilled water
Capacity	1.7 US gal (6.5 ℓ)
	(change including the remaining 0.17 US gal (0.64 ℓ) in the reserve tank)

اداره فروش فارما

تلفن شبانه روزی: ۰۲۱-۸۸۸۶۲۰۸۵

FarmaSOS.com

■ Tire

Regular	Size	215/55R17 94V ^{*1} 235/45R18 94V ^{*2}
	Pressure psi (kPa [kgf/cm ²]) Front	33 (225 [2.3])
Regular	Rear	33 (225 [2.3]) ^{*1} 32 (220 [2.2]) ^{*2}
	Size	T125/80D16 97M
Compact Spare	Pressure psi (kPa [kgf/cm ²])	60 (420 [4.2])
Wheel Size	Regular	17 x 7 1/2J ^{*1} 18 x 8J ^{*2}
	Compact Spare	16 x 4T

*1: U.S. models and Canadian EX-L V6 models

*2: Canadian V6 Touring models

Vehicle Identification Number (VIN), Engine Number and Transmission Number

Your vehicle has a 17-digit vehicle identification number (VIN) used to register your vehicle for warranty purposes, and for licensing and insuring your vehicle.

The locations of your vehicle's VIN, engine number and transmission number are shown as follows.

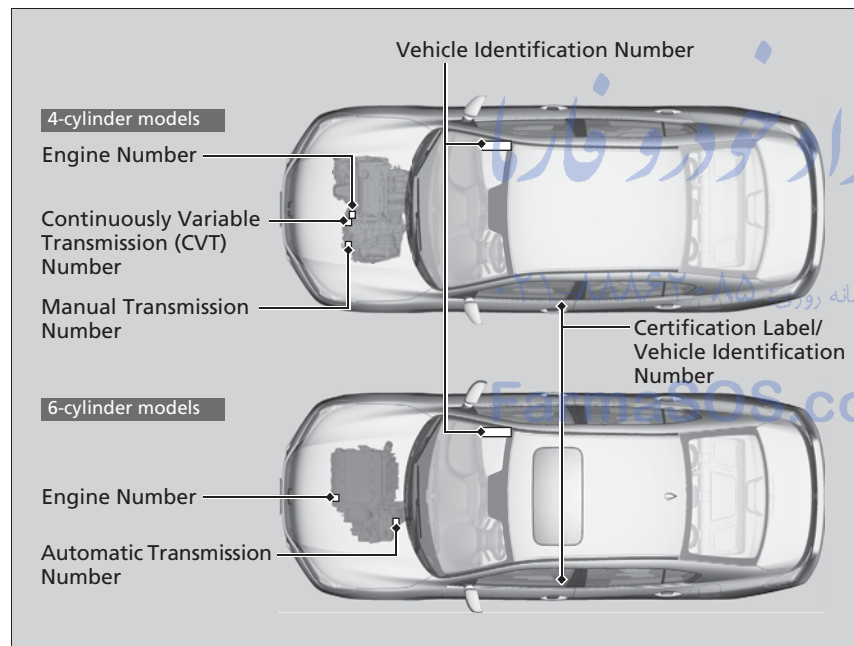

Vehicle Identification Number (VIN), Engine Number and Transmission Number

The interior vehicle identification number (VIN) is located under the cover.

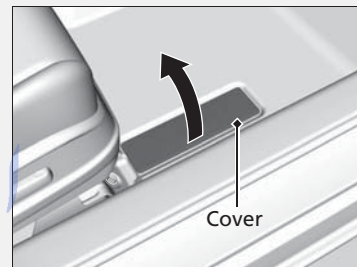

Devices that Emit Radio Waves

The following products and systems on your vehicle emit radio waves when in operation.

Audio System

Bluetooth® Audio

Bluetooth® HandsFreeLink®

HomeLink® Universal Transceiver

Immobilizer System

Keyless Access System

Remote Transmitter

Each of the above complies with the appropriate requirements or the required standards of FCC (Federal Communications Commission) and Industry Canada Standard, described below:

As required by the FCC:

This device complies with Part 15 of the FCC rules. Operation is subject to the following two conditions: (1) This device may not cause harmful interference, and (2) this device must accept any interference received, including interference that may cause undesired operation.

Changes or modifications not expressly approved by the party responsible for compliance could void the user's authority to operate the equipment.

This device complies with Industry Canada Standard RSS-Gen/210/310. Operation is subject to the following two conditions: (1) this device may not cause interference, and (2) this device must accept any interference, including interference that may cause undesired operation of the device.

In the U.S.

If you believe that your vehicle has a defect which could cause a crash or could cause injury or death, you should immediately inform the National Highway Traffic Safety Administration (NHTSA) in addition to notifying American Honda Motor Co., Inc.

If NHTSA receives similar complaints, it may open an investigation, and if it finds that a safety defect exists in a group of vehicles, it may order a recall and remedy campaign. However, NHTSA cannot become involved in individual problems between you, your dealer, or American Honda Motor Co., Inc.

To contact NHTSA, you may call the Vehicle Safety Hotline toll-free at 1-888-327-4236 (TTY: 1-800-424-9153); go to <http://www.safercar.gov>; or write to: Administrator, NHTSA, 1200 New Jersey Avenue, SE., Washington, DC 20590. You can also obtain other information about motor vehicle safety from <http://www.safercar.gov>.

In Canada

If you believe that your vehicle has a defect which could cause a crash or could cause injury or death, you should immediately inform Honda Canada Inc. and you may also inform Transport Canada.

If Transport Canada receives similar complaints, it may open an investigation, and if it finds that a safety defect exists in a group of vehicles, it may lead to a recall and remedy campaign. However, Transport Canada cannot become involved in individual problems between you, your dealer, or Honda Canada Inc.

To contact Transport Canada's Defect Investigations and Recalls Division, you may call 1-800-333-0510. For more information on reporting safety defects or about motor vehicle safety, go to <http://www.tc.gc.ca/roadsafety>.

Testing of Readiness Codes

Your vehicle has “Readiness Codes,” as part of the onboard self diagnostic system. Some States use these codes as a test to see if your vehicle's emissions components are working properly.

The codes may not be read properly if testing is performed just after the battery has gone dead or been disconnected.

To check if they are set, turn the ignition switch to ON **II***1, without starting the engine. The malfunction indicator lamp will come on for several seconds. If it then goes off, the readiness codes are set. If it blinks five times, the readiness codes are not set.

If you are required to have your vehicle tested before the readiness codes are ready, prepare the vehicle for retesting by doing the following:

1. Fill the gas tank to approximately 3/4 full.
2. Park the vehicle and leave the engine off for six hours or more.
3. Make sure the ambient temperature is between 40°F and 95°F (4°C and 35°C).
4. Start the engine without touching the accelerator pedal, and let it idle for 20 seconds.
5. Keep the vehicle in **P** (automatic transmission/CVT) or **N** (manual transmission). Increase the engine speed to 2,000 rpm, and hold it there for about three minutes.
6. Let the engine idle with your foot off the accelerator for 20 seconds.

*1: Models with the smart entry system have an **ENGINE START/STOP** button instead of an ignition switch.

Testing of Readiness Codes

The readiness codes are erased when the battery is disconnected, and set again only after several days of driving under a variety of conditions.

If a testing facility determines that the readiness codes are not set, you may be requested to return at a later date to complete the test.

If the testing facility determines the readiness codes are still not set, see a dealer.

7. Select a nearby, lightly traveled major highway where you can maintain a speed of 50 to 60 mph (80 to 97 km/h) for at least 20 minutes. Drive on the highway in **D** (automatic/CVT) or 5th (manual). Do not use cruise control. When traffic allows, drive for 90 seconds without moving the accelerator pedal. (Vehicle speed may vary slightly; this is okay.) If you cannot do this for a continuous 90 seconds because of traffic conditions, drive for at least 30 seconds, then repeat it two more times (for a total of 90 seconds).
8. Drive in city/suburban traffic for at least 10 minutes. When traffic conditions allow, let the vehicle coast for several seconds without using the accelerator pedal or the brake pedal.
9. Park the vehicle and leave the engine off for 30 minutes.

امداد خودرو فارما

تلفن شبانه روزی: ۰۲۱-۸۸۸۶۲۰۸۵

FarmaSOS.com

■ U.S. Owners

Your new vehicle is covered by these warranties:

New Vehicle Limited Warranty – covers your new vehicle, except for the emissions control systems and accessories, against defects in materials and workmanship.

Emissions Control Systems Defects Warranty and Emissions Performance Warranty – these two warranties cover your vehicle's emissions control systems. Time, mileage, and coverage are conditional. Please read your warranty booklet for exact information.

Seat Belt Limited Warranty – a seat belt that fails to function properly is covered by a limited warranty. Please read your warranty booklet for details.

Rust Perforation Limited Warranty – all exterior body panels are covered for rust-through from the inside for the specified time period with no mileage limit.

Accessory Limited Warranty – Honda accessories are covered under this warranty. Time and mileage limits depend on the type of accessory and other factors. Please read your warranty booklet for details.

Replacement Parts Limited Warranty – covers all Honda replacement parts against defects in materials and workmanship.

Replacement Battery Limited Warranty – provides prorated coverage for a replacement battery purchased from a dealer.

Replacement Muffler Lifetime Limited Warranty – provides coverage for as long as the purchaser of the muffler owns the vehicle.

Restrictions and exclusions apply to all these warranties. Please read the Honda warranty information booklet that came with your vehicle for precise information on warranty coverages. Your vehicle's original tires are covered by their manufacturer. Tire warranty information is in a separate booklet.

■ **Canadian Owners**

Please refer to the warranty manual that came with your vehicle.

امداد خودرو فارما
تلفن شبانه روزی: ۰۲۱-۸۸۸۶۲۰۸۵

FarmaSOS.com

■ Service Express

For electronic copies of service publications, you can purchase a subscription to Service Express. Visit www.techinfo.honda.com for pricing and options.

■ For U.S. Owners:

Manuals can be purchased from Helm Incorporated. You can order a manual by phone at (800) 782-4356 (credit card orders only), or online at www.helminc.com.

امداد خودرو فارما

تلفن شبانه روزی: ۰۲۱-۸۸۸۶۲۰۸۵

FarmaSOS.com

Authorized Manuals

For Canadian Owners:

Please contact a dealer to order any manuals that you may require.

Honda dealership personnel are trained professionals.

They should be able to answer all your questions. If you encounter a problem that your dealership does not solve to your satisfaction, please discuss it with the dealership's service manager or general manager. If you are dissatisfied with the decision made by the dealership's management, contact Honda Customer Services.

U.S. Owners:

American Honda Motor Co., Inc.
Honda Automobile Customer Services
Mail Stop 500-2N-7A
1919 Torrance Blvd.
Torrance, CA 90501-2746
Tel: (800) 999-1009

Canadian Owners:

Honda Canada Inc.
Customer Relations
180 Honda Boulevard
Markham, ON
L6C 0H9
Tel: 1-888-9-HONDA-9
Fax: 1-877-939-0909
E-mail: Honda_cr@ch.honda.com

In Puerto Rico and the U.S. Virgin Islands:

Bella International
P.O. Box 190816
San Juan, PR 00919-0816
Tel: (787) 620-7546

Customer Service Information

When you call or write, please give us the following information:

- Vehicle Identification Number
 - ▣ **Vehicle Identification Number (VIN), Engine Number and Transmission Number P. 572**
- Date of purchase
- Odometer reading of your vehicle
- Your name, address, and telephone number
- A detailed description of the problem
- Name of the dealer who sold the vehicle to you

Gracenote Music Recognition Service (CDDB)



Music recognition technology and related data are provided by Gracenote®. Gracenote is the industry standard in music recognition technology and related content delivery.

For more information, visit www.gracenote.com.

When music is recorded to the HDD from a CD, information such as the recording artist and track name are retrieved from the Gracenote Database and displayed (when available).

Gracenote may not contain information for all albums.

Gracenote is an internet-based music recognition service that allows artist, album, and track information from CDs to display on the HDD.

Gracenote users are allowed 4 free updates a year. More information about Gracenote, its features, and downloads are available at

www.honda.com (in U.S.) or www.honda.ca (in Canada). CD and music-related data from Gracenote, Inc., copyright © 2000 to present Gracenote. Gracenote Software, copyright © 2000 to present Gracenote. One or more patents owned by Gracenote apply to this product and service. See the Gracenote website for a non-exhaustive list of applicable Gracenote patents. Gracenote, CDDB, MusicID, MediaVOCS, the Gracenote logo and logotype, and the "Powered by Gracenote" logo are either registered trademarks or trademarks of Gracenote in the United States and/or other countries.

Gracenote® END USER LICENSE AGREEMENT

This application or device contains software from Gracenote, Inc. of Emeryville, California ("Gracenote"). The software from Gracenote (the "Gracenote Software") enables this application to perform disc and/or file identification and obtain music-related information, including name, artist, track, and title information ("Gracenote Data") from online servers or

embedded databases (collectively, "Gracenote Servers") and to perform other functions. You may use Gracenote Data only by means of the intended End-User functions or this application or device.

You agree that you will use Gracenote Data, the Gracenote Software, and Gracenote Servers for your own personal non-commercial use only.

You agree not to assign, copy, transfer, or transmit the Gracenote Software or any Gracenote Data to any third party.

YOU AGREE NOT TO USE OR EXPLOIT GRACENOTE DATA, THE GRACENOTE SOFTWARE, OR GRACENOTE SERVERS, EXCEPT AS EXPRESSLY PERMITTED HEREIN.

You agree that your non-exclusive license to use the Gracenote Data, the Gracenote Software, and Gracenote Servers will terminate if you violate these restrictions. If your license terminates, you agree to cease any and all use of the Gracenote Data, the Gracenote Software, and Gracenote Servers.

Gracenote reserves all rights in Gracenote Data, the Gracenote Software, and the Gracenote Servers, including all ownership rights. Under no circumstances will Gracenote become liable for any payment to you for any information that you provide. You agree that Gracenote, Inc. may enforce its rights under this Agreement against you directly in its own name.

The Gracenote service uses a unique identifier to track queries for statistical purposes. The purpose of a randomly assigned numeric identifier is to allow the Gracenote service to count queries without knowing anything about who you are. For more information, see the web page for the Gracenote Privacy Policy for the Gracenote service.

The Gracenote Software and each item of Gracenote Data are licensed to you "AS IS."

Gracenote makes no representations or warranties, express or implied, regarding the accuracy of any Gracenote Data from in the Gracenote Servers. Gracenote reserves the right to delete data from the Gracenote Servers or to change data categories for any

cause that Gracenote deems sufficient. No warranty is made that the Gracenote Software or Gracenote Servers are error-free or that functioning of Gracenote Software or Gracenote Servers will be uninterrupted.

Gracenote is not obligated to provide you with new enhanced or additional data types or categories that Gracenote may provide in the future and is free to discontinue its services at any time.

GRACENOTE DISCLAIMS ALL WARRANTIES EXPRESS OR IMPLIED, INCLUDING, BUT NOT LIMITED TO, IMPLIED WARRANTIES OF MERCHANTABILITY, FITNESS FOR A PARTICULAR PURPOSE, TITLE, AND NONINFRINGEMENT. GRACENOTE DOES NOT WARRANT THE RESULTS THAT WILL BE OBTAINED BY YOUR USE OF THE GRACENOTE SOFTWARE OR ANY GRACENOTE SERVER. IN NO CASE WILL GRACENOTE BE LIABLE FOR ANY CONSEQUENTIAL OR INCIDENTAL DAMAGES OR FOR ANY LOST PROFITS OR LOST REVENUES.

© Gracenote 2009

Disclaimer of Pandora®

Requirements to access Pandora®

- Latest version of the Pandora application installed on your mobile device. (Visit the Apple iTunes store or Google Play Marketplace to download the latest version.)
- Registered Pandora account (you can create a free account at www.pandora.com <<http://www.pandora.com/>> or on your smartphone)
- Connection to the internet via WiFi or cellular data network.
- Android devices must be connected to the vehicle via *Bluetooth*, iPhone devices may be connected via *Bluetooth* or USB.

Limitations

- Access to Pandora requires an active internet connection
- Ability to access Pandora through this system is subject to change without notice
- Certain functionality of Pandora service is not available when accessing the service through this system including, but not limited to, creating new stations, deleting stations, emailing current stations, buying songs, viewing additional text information, logging in to Pandora, and adjusting Cell Network Audio Quality. Pandora internet radio is a music service not affiliated with HONDA. More information is available at <http://www.pandora.com> <<http://www.pandora.com>>. Pandora, the Pandora logo, and the Pandora trade dress are trademarks or registered trademarks of Pandora Media, Inc., used with permission.
- Mobile access requires a smartphone with an active data plan. Standard data rates may apply.
- Pandora is only available in the United States.

امداد خودرو فارما

تلفن شبانه روزی: ۰۲۱-۸۸۸۶۲۰۸۵

FarmaSOS.com

Numbers

7-Speed Manual Shift Mode	437
Operation	438

A

ABS (Anti-lock Brake System)	474
Accessories and Modifications	482
Accessory Power Sockets	161
Adaptive Cruise Control (ACC)	448
Additives	
Coolant	505
Engine Oil	499
Washer	510
Additives, Engine Oil	499
Adjusting	
Armrest	155
Clock	106
Front Seats	148
Head Restraints	151
Mirrors	146
Rear Seats	154
Steering Wheel	145
Temperature	92, 96
Aha™ Radio	229, 282
Air Conditioning System (Climate Control System)	169
Changing the Mode	169
Defrosting the Windshield and Windows	170
Dust and Pollen Filter	535

Recirculation/Fresh Air Mode	169
Sensor	172
Synchronized Mode	171
Using Automatic Climate Control	169
Air Conditioning System (Heating and Cooling System)	166
Cooling	168
Defrosting the Windshield and Windows	168
Dust and Pollen Filter	535
Heating	167
Air Pressure	524, 569, 571
Airbags	39
Advanced Airbags	45
After a Collision	42
Airbag Care	51
Event Data Recorder	0
Front Airbags (SRS)	42
Indicator	49, 72
Passenger Airbag Off Indicator	50
Sensors	39
Side Airbags	46
Side Curtain Airbags	48
AM/FM Radio	187, 213, 252
Anti-lock Brake System (ABS)	474
Indicator	72
Armrest	155
Audio Remote Controls	179
Audio System	174
Adjusting the Sound	185, 211, 242
Auxiliary Input Jack	176

Error Messages	288
General Information	294
HDD	262
Internet Radio	195, 227, 280
iPod	192, 223, 272
MP3/WMA/AAC	197, 230, 283
Reactivating	177
Recommended CDs	295
Recommended Devices	297
Remote Controls	179
Security Code	177
Theft Protection	177
Touch Screen	203, 236
USB Flash Drives	297
USB Port	175
Authorized Manuals	579
Auto Door Locking/Unlocking	119
Customize	102, 309, 327
Automatic Lighting	137
Automatic Transmission	
Creeping	432
Fluid	508
Kickdown	432
Operating the Shift Lever	20, 440
Shift Lever Does Not Move	555
Shifting	439
Auxiliary Input Jack	176
Average Fuel Economy	91, 95
Average Speed	96

B			
Battery	532		
Charging System Indicator	69, 558		
Jump Starting	552		
Maintenance (Checking the Battery)	532		
Maintenance (Replacing)	533		
Belts (Seat)	32		
Beverage Holders	160		
Bluetooth® Audio	200, 233, 286		
Bluetooth® HandsFreeLink®	338, 375		
Booster Seats (For Children)	63		
Brake System	472		
Anti-lock Brake System (ABS)	474		
Brake Assist System	475		
Fluid	509		
Foot Brake	473		
Indicator	68, 560		
Parking Brake	472		
Brake System Indicator (Amber)	68		
Brake System Indicator (Red)	68		
Brightness Control (Instrument Panel) ...	141		
Bulb Replacement	511		
Brake/Taillights and Rear Turn Signal Lights/ Rear Side Marker Lights	518		
Fog Lights	513		
Front Turn Signal/Side Marker Lights	516		
Headlights	511		
High-Mount Brake Light	520		
Parking Lights	517		
Parking/Daytime Running Lights	517		
Rear License Plate Lights	520		
Side Turn Signal/Emergency Indicator Lights	516		
Taillights and Back-Up Lights	519		
Bulb Specifications	568, 570		
C			
Carbon Monoxide Gas	64		
Cargo Hooks	162		
Carrying Cargo	417, 419		
CD Player	189, 220, 259		
Center Pocket	159		
Certification Label	572		
Changing Bulbs	511		
Charging System Indicator	69, 558		
Child Safety	52		
Childproof Door Locks	118		
Emergency Trunk Opener	123		
Child Seat	52		
Booster Seats	63		
Child Seat for Infants	54		
Child Seat for Small Children	55		
Installing a Child Seat with a Lap/Shoulder Seat Belt	59		
Larger Children	62		
Rear-facing Child Seat	54		
Selecting a Child Seat	56		
Using a Tether	61		
Childproof Door Locks	118		
Cleaning the Exterior	538		
Cleaning the Interior	536		
Climate Control System	169		
Changing the Mode	169		
Defrosting the Windshield and Windows	170		
Dust and Pollen Filter	535		
Recirculation and Fresh Air Mode	169		
Sensors	172		
Synchronized Mode	171		
Using Automatic Climate Control	169		
Clock	106		
Clutch Fluid	509		
Coat Hook	162		
Compact Spare Tire	543, 569, 571		
Compass	413		
Console Compartment	158		
Continuously Variable Transmission (CVT)			
Creeping	432		
Fluid	507		
Kickdown	432		
Operating the Shift Lever	19, 434, 436		
Shift Lever Does Not Move	555		
Shifting	433, 435		
Controls	105		
Coolant (Engine)	505		
Adding to the Engine Coolant Reserve Tank	505		
Adding to the Radiator	506		
Overheating	556		
Creeping (Automatic Transmission/ CVT)	432		

Cruise Control	445
Indicator	80
Cup Holders.....	160
Customer Service Information	580
Customized Features	97, 298

D

Daytime Running Lights.....	139
Dead Battery	552
Defrosting the Windshield and Windows.....	168, 170
Devices that Emit Radio Waves.....	573
Dimming	
Headlights	136
Rearview Mirror.....	146
Dipstick (Engine Oil).....	500
Directional Signals (Turn Signal).....	136
Display Button	181, 206, 238
Door Mirrors	147
Doors	108
Auto Door Locking	119
Auto Door Unlocking.....	119
Door and Trunk Open Indicator	31, 74
Keys	108
Locking/Unlocking the Doors from the Inside.....	116
Locking/Unlocking the Doors from the Outside.....	111
Lockout Prevention System	115

DOT Tire Quality Grading	526
Driving	415
Adaptive Cruise Control (ACC).....	448
Automatic Transmission/CVT.....	432
Braking	472
Cruise Control.....	445
Shifting Gear.....	439, 441
Shifting Position	433, 435
Starting the Engine.....	425, 427

Driving Position Memory System	143
Dust and Pollen Filter.....	535

E

Eco Assist System	9
ECON Button	444
Elapsed Time	95
Electric Power Steering (EPS) System Indicator.....	74, 560
Electronic Stability Control (ESC).....	464
Emergency	565
Emergency Engine Stop	551
Emergency Trunk Opener.....	123
Emissions Testing (Readiness Codes).....	575
Engine	572
Coolant.....	505
Jump Starting.....	552
Oil.....	499
Starting	425, 427
Switch Buzzer.....	131

Engine Coolant	505
Adding to the Engine Coolant Reserve Tank	505
Adding to the Radiator	506
Overheating.....	556
Temperature Gauge.....	89
Engine Oil	499
Adding	502
Checking	500
Displaying Oil Life	487, 491
Low Oil Pressure Indicator	69, 558
Recommended Engine Oil	499
ENGINE START/STOP Button.....	132
EPS (Electric Power Steering) System	74, 560
Exhaust Gas Hazard (Carbon Monoxide)	64
Expanded View Driver's Mirror.....	147
Exterior Care (Cleaning)	538
Exterior Mirrors.....	147

F

Features	173
Filters	
Dust and Pollen.....	535
Oil	503
Flat Tire.....	543
Floor Mats	537

Fluids	
Automatic Transmission	508
Brake/Clutch	509
Continuously Variable Transmission (CVT)	507
Engine Coolant	505
Manual Transmission	507
Windshield Washer	510
Fog Light Indicator	77
Folding Down the Rear Seat	154
Foot Brake	473
Forward Collision Warning (FCW)	456
Front Airbags (SRS)	42
Front Seats	148
Adjusting	148
Fuel	21, 479
Economy.....	481
Gauge	89
Instant Fuel Economy	91, 96
Low Fuel Indicator.....	72
Range	92, 95
Recommendation.....	479
Refueling	479
Fuel Economy	481
Fuel Fill Cap	21, 480
Message	559
Fuel Fill Door	21, 480
Fuses	562
Inspecting and Changing	564
Locations	562, 563

G

Gasoline (Fuel)

Economy	481
Gauge	89
Information	479
Instant Fuel Economy.....	91, 96
Low Fuel Indicator	72
Refueling.....	479
Gauges	89

Gear Shift Lever Positions

Automatic Transmission.....	439
Continuously Variable Transmission (CVT)	433, 435
Manual Transmission	442

Glass (care)

.....	539
-------	-----

Glove Box

.....	158
-------	-----

H

Halogen Bulbs.....

.....	511, 513
-------	----------

Handling the Unexpected

.....	541
-------	-----

HandsFreeLink® (HFL)

Auto Answer	338, 375
Auto Answer	354, 390
Automatic Import of Cellular Phonebook and Call History	356, 392
Automatic Transferring	354, 390
Displaying Messages	370, 409
Editing User Name	389
HFL Buttons.....	338, 375
HFL Menus	341, 377
HFL Status Display	340, 376

Limitations for Manual Operation	340, 376
Making a Call.....	360, 401
Options During a Call	367, 406
Phone Setup.....	346, 381
Phonebook Phonetic Modification	396
Receiving a Call	366, 405
Receiving a Text/E-Mail Message	368, 407
Ring Tone.....	355, 391
Selecting a Mail Account.....	369, 408
Speed Dial.....	357, 393
To Create a Security PIN	353, 388
To Set Up a Text/E-Mail Message	

Options	351, 386
Use Contact Photo	355, 391

Hard Disk Drive (HDD) Audio

.....	262
-------	-----

Hazard Warning Button

.....	4
-------	---

Head Restraints

.....	151
-------	-----

Headlights.....

Aiming	511
Automatic Operation.....	137
Dimming	136, 139
Operating.....	136

Heaters (Seat)

.....	164, 165
-------	----------

Heating and Cooling System

Cooling	168
Defrosting the Windshield and Windows.....	168
Dust and Pollen Filter.....	535
Heating.....	167

High Beam Indicator

.....	76
-------	----

Hill Start Assist System

.....	426, 430
-------	----------

HomeLink® Universal Transceiver 336

I

Identification Numbers

Engine and Transmission 572

Vehicle Identification 572

Ignition Switch 131

Illumination Control

Knob 141

Immobilizer System 124

Indicator 77

Indicators 68

Adaptive Cruise Control (ACC) 80

Anti-lock Brake System (ABS) 72

Brake System (Amber) 68

Brake System (Red) 68

Charging System 69, 558

CRUISE CONTROL 80, 446

CRUISE MAIN 80, 445

Door and Trunk Open 74

ECON Mode 80, 444

Electric Power Steering (EPS)

System 74, 560

Fog Light 77

Forward Collision Warning (FCW) 78

High Beam 76

Immobilizer System 77

Lane Departure Warning (LDW) 79

Light Control 81

Lights On 76

Low Fuel 72

Low Oil Pressure 69, 558

Low Tire Pressure/TPMS 75, 468, 470

Maintenance Minder 80, 487

Malfunction Indicator Lamp 69, 559

Parking Brake and Brake System 68, 560

Seat Belt Reminder 33, 71

Security System Alarm 77

Smart Entry System 81

Starter System 81

Supplemental Restraint System 49, 72

System Message 76

Transmission 71

Turn Signal and Hazard Warning 76

Vehicle Stability Assist (VSA®)

System 73, 464

VSA® OFF 73, 465

Washer Level 80

Information 567

Information Display 90

Instant Fuel Economy 91, 96

Instrument Panel 67

Brightness Control 141

Interface Dial 235

Interior Lights 156

Interior Rearview Mirror 146

J

Jack (Wheel Nut Wrench) 546

Jump Starting 552

K

Key Number Tag 109

Keyless Lockout Prevention 115

Keys 108

Lockout Prevention 115

Master Keys 108

Number Tag 109

Rear Door Won't Open 118

Remote Transmitter 111

Types and Functions 108

Valet Key 109, 122

Won't Turn 24

Kickdown (Automatic Transmission/
CVT) 432

L

Lane Departure Warning (LDW) 460

LaneWatch™ 466

Language (HFL) 340, 376

LATCH (Child Seats) 57

Lights 136, 511

Automatic 137

Bulb Replacement 511

Daytime Running Lights 139

Fog Lights 138

High Beam Indicator 76

Interior 156

Light Switches 136

Lights On Indicator 76

Turn Signals 136

Puncture (Tire) 543

R

Radiator 506

Radio (AM/FM) 187, 213, 252

Radio (SiriusXM®) 217, 256

Radio Data System (RDS) 188, 215, 254

Range 92, 95

RDS (Radio Data System) 188, 215, 254

Readiness Codes (Emissions Testing) 575

Rear Defogger/Heated Door Mirror

 Button 142

Rear Seat (Folding Down) 154

Rear Seat Heaters 165

Rearview Camera 478

Rearview Mirror 146

Refueling 479

 Fuel Gauge 89

 Gasoline 479, 568, 570

 Low Fuel Indicator 72

Regulations 470, 526, 573

Remote Transmitter 111

Replacement

 Battery 533

 Bulbs 511

 Fuses 562, 563

 Tires 529

 Wiper Blade Rubber 521

Reporting Safety Defects 574

Resetting a Trip Meter 91, 95

S

Safe Driving 27

Safety Check 31

Safety Labels 65

Safety Message 1

Seat Belts 32

 Adjusting the Shoulder Anchor 36

 Automatic Seat Belt Tensioners 34

 Checking 38

 Fastening 35

 Installing a Child Seat with a Lap/Shoulder Seat

 Belt 59

 Pregnant Women 37

 Reminder 33

 Warning Indicator 33, 71

Seat Heaters 164, 165

Seats 148

 Adjusting 148

 Front Seats 148

 Rear Seats 154

 Seat Heaters 164, 165

Security System 124

 Immobilizer System Indicator 77

 Security System Alarm Indicator 77

SEL/RESET Button 94

Select/Reset Knob 90

Selecting a Child Seat 56

Selector Knob (Audio) 180, 202

Shift Lever 19, 433, 435, 439, 441

 Operation 19, 434, 436, 440, 441

 Releasing 555

 Won't Move 555

Shift Lever Position

 Indicator 70, 434, 436, 440

Shifting (Transmission) 433, 435, 439, 441

Shoulder Anchor 36

Side Airbags 46

Side Curtain Airbags 48

SiriusXM® Radio 217, 256

Smart Entry with Push Button Start

 System 113

Snow Tires 531

Spare Tire 543, 569, 571

Spark Plugs 568, 570

Specifications 568

Specified Fuel 479, 568, 570

Speedometer 89

SRS Airbags (Airbags) 42

Starting the Engine 425, 427

 Does Not Start 549

 Engine Switch Buzzer 131

 Jump Starting 552

Steering Wheel 145

 Adjusting 145

Stopping 476

Summer Tires 531

Sunglasses Holder 163

Supplemental Restraint System (SRS) 42

Switches (Around the Steering

 Wheel) 4, 5, 131

SYNC Mode 171

System Message Indicator 76

T

Tachometer	89
Temperature	
Outside Temperature Display	92, 96
Temperature Sensor	92, 96, 172
Time (Setting).....	106
Tire Pressure Monitoring System	
(TPMS).....	468
Indicator	75, 561
Tires	523
Air Pressure.....	524, 569, 571
Checking and Maintaining	523
Inspection	523
Labeling.....	524
Puncture (Flat Tire).....	543
Regulations.....	526
Rotation.....	530
Spare Tire	543, 569, 571
Summer.....	531
Tire Chains.....	531
Wear Indicators.....	528
Winter	531
Tools	542
Towing a Trailer	421
Equipment and Accessories.....	422
Load Limits	421
Towing Your Vehicle	424
Emergency.....	565
TPMS (Tire Pressure Monitoring System).....	468
Indicator	75, 561

Transmission	433, 435, 439, 441
Automatic	439
Continuously Variable (CVT)	433, 435
Fluid	507, 508
Manual.....	441
Number.....	572
Shift Lever Position	
Indicator	70, 434, 436, 440
Trip Meter	91, 95
Troubleshooting	541
Blown Fuse	562, 563
Brake Pedal Vibrates	24
Buzzer Sounds When Opening Door.....	25
Emergency Towing	565
Engine Won't Start	549
Noise When Braking	25
Overheating	556
Puncture/Flat Tire	543
Rear Door Won't Open	25, 118
Shift Lever Won't Move	555
Warning Indicators	68
Trunk	120
Lid.....	120
Light Bulb.....	568, 570
Main Switch	122
Turn Signals	136
Indicators (Instrument Panel).....	76

U

Unlocking the Doors	111
---------------------------	-----

Unlocking the Front Doors from the Inside	13
USB Flash Drives	297
USB Port.....	175
Using the Smart Entry with Push Button Start System	113

V

Valet Key.....	109, 122
Vanity Mirrors.....	7
Vehicle Identification Number	572
Vehicle Stability Assist (VSA®).....	464
Off Button.....	465
Off Indicator.....	73
System Indicator.....	73
Ventilation.....	166, 169
Viscosity (Oil)	499, 569, 571
VSA® (Vehicle Stability Assist).....	464

W

Warning and Information Messages... 82, 84	
Warning Indicator On/Blinking	558
Warning Labels.....	65
Warranties (Warranty Manual provided separately)	577
Watts.....	568, 570
Wear Indicators (Tire)	528
Wheel Nut Wrench (Jack Handle)	546

Window Washers	140
Adding/Refilling Fluid.....	510
Switch	140
Windows (Opening and Closing)	127
Windshield	140
Cleaning.....	539
Defrosting/Defogging	168, 170
Washer Fluid.....	510
Wiper Blades	521
Wipers and Washers	140
Winter Tires	531
Snow Tires.....	531
Tire Chains	531
Wipers and Washers	140
Checking and Replacing Wiper Blades	521
WMA	189, 197, 220, 230, 259, 283
Worn Tires	523

امداد خودرو فارما

تلفن شبانه روزی: ۰۲۱-۸۸۸۶۲۰۸۵

FarmaSOS.com