



PORSCHE



Panamera

Owner's Manual

WKD 970 121 10

06/09

Porsche, the Porsche Crest, Panamera, PCCB, PCM, PDK, PSM and Tequipment are registered trademarks and the distinctive shapes of Porsche automobiles are trademarks of Dr. Ing. h.c. F. Porsche AG.

All rights reserved.

Printed in Germany

Orientation guides in the Owner's Manual

The orientation guides in the Owner's Manual are highlighted in yellow.

Overall Table of Contents

At the start of the Owner's Manual you will find an overview of the overall contents of the Owner's Manual.

Section Contents

There is a summary of topics with the corresponding page numbers at the beginning of each main chapter.

Index

There is a detailed, alphabetical index at the end of this Owner's Manual.

تلفن شبانه روزی: ۰۲۱-۸۸۸۶۲۰۸۵

FarmaSOS.com

Dear Owner,

We would like to thank you for your purchase of a Porsche Panamera. Judging by the car you have chosen, you are a motorist of a special breed, and you are probably no novice when it comes to automobiles.

Remember however, as with any vehicle, you should take time to familiarize yourself with your Porsche and its performance characteristics. Always drive within your own unique capabilities as a driver and your level of experience with your Porsche. Ensure that anyone else driving your Porsche does the same. To prevent or minimize injury, always use your safety belts. Never consume alcohol or drugs before or during the operation of your vehicle.

This Owner's Manual contains a host of useful information. Please take the time to read this manual before you drive your new Porsche. Become familiar with the operation of your Porsche car for maximum safety and operating pleasure. The better you know your Porsche, the more pleasure you will experience driving your new car.

Always keep your Owner's Manual in the car, and give it to the new owner if you ever sell your Porsche.

A separate Maintenance Booklet explains how you can keep your Porsche in top driving condition by having it serviced regularly.

A separate Warranty and Customer Information Booklet contains detailed information about the warranties covering your Porsche.

For U.S. only:

If you believe that your vehicle has a fault which could cause a crash, injury or death, you should immediately inform the National Highway Traffic Safety Administration (NHTSA) in addition to notifying Porsche Cars North America, Inc. (Porsche Cars N.A.).

If NHTSA receives similar complaints, it may open an investigation, and if it finds that a safety problem exists in a group of vehicles, it may order a recall and remedy campaign. However, NHTSA cannot become involved in individual problems between you and your dealer, or Porsche Cars N.A..
تلفن شبانه روزی: ۱-۸۸۸-۳۲۷-۴۲۳۶

To contact NHTSA, you may call the Vehicle Safety Hotline toll-free at 1-888-327-4236 (TTY: 1-800-424-9153); go to <http://www.safercar.gov>; or write to: Administrator, NHTSA, 400 Seventh Street, SW., Washington, DC 20590.

You can also obtain other information about motor vehicle safety from <http://www.safercar.gov>.

Your car has thousands of parts and components which have been designed and manufactured in accordance with Porsche's high standards of engineering quality and safety.

Warning!

Any alteration or misuse of the vehicle can lead to accidents and serious or fatal personal injuries.

Any alteration of the vehicle may negate or interfere with those safety features built into the vehicle. Modifications may be carried out on your vehicle only if approved by Porsche. Your Porsche is intended to be used in a safe manner obeying the local laws and in the light of driving conditions faced by you, and in accordance with the instructions provided in this Owner's Manual.

- ▷ Do not misuse your Porsche by ignoring those laws and driving conditions, or by ignoring the instructions in this manual.

Regularly check your vehicle for signs of damage.

Damaged or missing aerodynamic components such as spoilers or underside panels affect the driving behavior and therefore must be replaced immediately.

Your car may have all or some of the components described in this manual.

Should you have difficulty understanding any of the explanations of features or equipment installed in your vehicle, contact your authorized Porsche dealer. They will be glad to assist you. Also check with your dealer on other available options or equipment.

Throughout this booklet, left is designated as the driver's side of the vehicle, and right as the passenger's side of the vehicle.

Text, illustrations and specifications in this manual are based on the information available at the time of printing.

It has always been Porsche's policy to continuously improve its products. Porsche, therefore, reserves the right to make changes in design and specification, and to make additions or improvements in its product without incurring any obligation to install them on products previously manufactured.

We wish you many miles of safe and pleasurable driving in your Porsche.

Important!

For your own protection and longer service life of your car, please heed all operating instructions and special warnings. These special warnings use the safety alert symbol, followed by the words **Danger, Warning and Caution**. These special warnings contain important messages regarding your safety and/or the potential for damage to your Porsche. Ignoring them could result in serious mechanical failure, serious personal injury or death.

- ▷ Do not alter your Porsche. Any alteration could create dangerous conditions or defeat safety engineering features built into your car.
- ▷ Do not misuse your Porsche. Use it safely, and consistently with the law, according to the driving conditions, and the instructions in this manual.

Alteration or misuse of your Porsche could cause accidents and serious personal injury or death.

Note to owners

In Canada, this manual is also available in French. To obtain a copy contact your dealer or write to:

Note aux propriétaires

Au Canada on peut se procurer un exemplaire de ce Manuel en français auprès du concessionnaire ou du:

Porsche Cars Canada, Ltd.
Automobiles Porsche Canada, LTEE

5925 Airport Road
Suite 420
Mississauga, Ontario
Canada, L4V 1W1

Telephone number for customer assistance:
1-800-PORSCHE / Option 3

Setting and operating vehicle components when driving

Warning!

There is a danger of accident if you set or operate the on-board computer, radio, navigation system, telephone or other equipment when driving. This could distract you from the traffic and cause you to lose control of the vehicle resulting in serious personal injury or death.

- ▷ Operate the components while driving only if the traffic situation allows you to do so safely.
 - ▷ Carry out any complicated operating or setting procedures only with the vehicle stationary.
-

Engine Exhaust

Danger!

Engine exhaust is dangerous if inhaled. Engine exhaust fumes have many components which you can smell. They also contain carbon monoxide (CO), which is a colorless and odorless gas. Carbon monoxide can cause unconsciousness and even death if inhaled.

- ▷ Never start or let the engine run in an enclosed, unventilated area. It is not recommended to sit in your car for prolonged periods with the engine on and the car not moving.
-

California Proposition 65 Warning



Warning!

Engine exhaust, some of its constituents, and certain vehicle components contain or emit chemicals known to the State of California to cause cancer and birth defects or other reproductive harm.

In addition, certain fluids contained in vehicles and certain products of component wear contain or emit chemicals known to the State of California to cause cancer and birth defects or other reproductive harm.

Hot Exhaust Pipes



Warning!

Risk of burn injury when standing near or coming into contact with the exhaust pipe.

The exhaust pipe is hot when the vehicle is running and remains hot for some time after the vehicle is turned off.

- ▷ To prevent injury, make a point of noting where your vehicle's exhaust pipe is, avoid placing your legs near the exhaust pipe when loading and unloading cargo in the rear, and closely supervise children around the vehicle during time when the exhaust pipe could be hot. A hot exhaust pipe can cause serious burns.

Portable Fuel Containers



Danger!

Portable fuel containers may leak, whether they are full or partially empty. Fuel leaking from a portable container carried in your vehicle could, in case of an accident, cause a fire or explosion, resulting in serious personal injury or death.

- ▷ Never carry additional fuel in portable containers in your vehicle.

Ground Clearance



Caution!

Risk of damage. The vehicle may touch the ground as a result of reduced ground clearance.

- ▷ Drive carefully and slowly on steep slopes (e. g. parking lots, curbs, uneven roads, lifting platforms etc.).
- ▷ Avoid steep ramps.

Porsche Ceramic Composite Brake (PCCB)

- ▷ Please see the chapter "BRAKES" on Page 172.

The high-performance brake system is designed for optimal braking effect at all speeds and temperatures. Certain speeds, braking forces and ambient conditions (such as temperature and humidity) therefore might cause brake noises.

Wear on the different components and braking system, such as brake pads and brake discs, depends to a great extent on the individual driving style and the conditions of use and therefore cannot be expressed in actual miles on the road.

The values communicated by Porsche are based on normal operation adapted to traffic. Wear increases considerably when the vehicle is driven on race tracks or through an aggressive driving style.

- ▷ Please consult an authorized Porsche dealer about the current guidelines in effect before such use of your vehicle.

Dear Porsche Owner,

A lot has gone into the manufacture of your Porsche, including advanced engineering, rigid quality control and demanding inspections. These engineering and safety features will be enhanced by you...

the safe driver...

- who knows her/his car and all controls,
- who maintains the vehicle properly,
- who uses driving skills wisely and always drives within her/his own capabilities and the level of familiarity with the vehicle.

You will find helpful hints in this manual on how to perform most of the checks listed on the following pages. If in doubt, have these checks performed by your authorized Porsche dealer.

Before driving off...

Check the following items first

- ▷ Turn the engine off before you attempt any checks or repairs on the vehicle.
- ▷ Be sure the tires are inflated correctly. Check tires for damage and tire wear.
- ▷ See that wheel bolts are properly tightened and not loose or missing.
- ▷ Check engine oil level, add if necessary. Make it a habit to have engine oil checked with every refueling.
- ▷ Check all fluid levels such as windshield washer and brake fluid levels.
- ▷ Be sure the vehicle battery is well charged and cranks the engine properly.
- ▷ Check all doors and lids for proper operation and latch them properly.
- ▷ Check and if necessary replace worn or cracked wiper blades.
- ▷ See that all windows are clear and unobstructed.
- ▷ Check air intake slots and area between engine compartment lid and windshield. Ensure that these areas are free of snow and ice, so the heater and the windshield wipers work properly.

- ▷ If a child will be riding in the vehicle, check child seat/child seat restraint system to ensure that restraints are properly adjusted.
- ▷ Check all exterior and interior lights for operation and that the lenses are clean.
- ▷ Check the headlights for proper aim, and if necessary, have them adjusted.
- ▷ Check under the vehicle for leaks.
- ▷ Be sure all luggage is stowed securely.

Emergency equipment

It is good practice to carry emergency equipment in your vehicle.

Some of the items you should have are: window scraper, snow brush, container or bag of sand or salt, emergency light, small shovel, first-aid kit, etc.

In the driver's seat...

- ▷ Check operation of the horn.
- ▷ Position seat for easy reach of foot pedals and controls. To reduce the possibility of injury from the air bag deployment, you should always sit back as far from the steering wheel as is practical, while still maintaining full vehicle control.
- ▷ Adjust the inside and outside rear view mirrors.
- ▷ Buckle your safety belts.
- ▷ Check operation of the foot and electric parking brake.
- ▷ Check all warning and indicator lights with ignition on and engine not running.
- ▷ Start engine and check all warning displays for warning symbols.
- ▷ Never leave an idling car unattended.
- ▷ Lock doors from inside, especially with children in the car to prevent inadvertent opening of doors from inside or outside. Drive with doors locked.

On the road...

- ▷ Never drive after you have consumed alcohol or drugs.
- ▷ Always have your safety belt fastened.
- ▷ Always drive defensively. Expect the unexpected.
- ▷ Use signals to indicate turns and lane changes.
- ▷ Turn on headlights at dusk or when the driving conditions warrant it.
- ▷ Always keep a safe distance from the vehicle in front of you, depending on traffic, road and weather conditions.
- ▷ Reduce speed at night and during inclement weather. Driving in wet weather requires caution and reduced speeds, particularly on roads with standing water, as the handling characteristics of the vehicle may be impaired due to hydroplaning of the tires.
- ▷ Always observe speed limits and obey road signs and traffic laws.
- ▷ When tired, get well off the road, stop and take a rest. Turn the engine off. Do not sit in the vehicle with engine idling. Please see the chapter "ENGINE EXHAUST" on Page 2.

- ▷ When parked, always put the electric parking brake on **and** put the PDK selector lever in position **P**. On hills also turn the front wheels toward the curb.
- ▷ When emergency repairs become necessary, move the vehicle well off the road. Turn on the emergency flasher and use other warning devices to alert other motorists. Do not park or operate the vehicle in areas where the hot exhaust system may come in contact with dry grass, brush, spilled fuel or other flammable material.
- ▷ Make it a habit to have the engine oil checked with every refueling.

Break in hints for the first 2,000 miles (3,000 kilometers)

The following tips will be helpful in obtaining optimum performance from your new Porsche.

Despite the most modern, high-precision manufacturing methods, the moving parts must still wear in with each other. This wearing-in occurs mainly in the first 2,000 miles (3,000 km).

Therefore:

- ▷ Preferably take longer trips.
- ▷ Avoid frequent cold starts with short-distance driving whenever possible.
- ▷ Avoid full throttle starts and abrupt stops.
- ▷ Do not exceed maximum engine speed of 4,200 rpm (revolutions per minute).
- ▷ Do not run a cold engine at high rpm either in Neutral or in gear.
- ▷ Do not let the engine labor, especially when driving uphill. Shift to the next lower gear in time (use the most favorable rpm range).
- ▷ Never lug the engine in high gear at low speeds. This rule applies at all times, not just during the break-in period.

- ▷ Do not participate in motor racing events, sports driving schools, etc. during the first 2,000 miles (3,000 kilometers).

There may be a slight stiffness in the steering or other controls during the break-in period which will gradually disappear.

Break in brake pads and brake discs

New brake pads and discs have to be "broken in", and therefore only attain optimal friction when the car has covered several hundred miles or km. The slightly reduced braking ability must be compensated for by pressing the brake pedal harder. This also applies whenever the brake pads and brake discs are replaced.

New tires

New tires do not have maximum traction. They tend to be slippery.

- ▷ Break in new tires by driving at moderate speeds during the first 60 to 120 miles (100 to 200 km). Longer braking distances must be anticipated.

Engine oil and fuel consumption

During the break-in period oil and fuel consumption may be higher than normal.

- ▷ Please see the chapter "ENGINE DATA" on Page 324.

As always, the rate of oil consumption depends on the quality and viscosity of oil, the speed at which the engine is operated, the climate and road conditions, as well as the amount of dilution and oxidation of the lubricant.

- ▷ Make a habit of checking engine oil with every refueling, add if necessary.

Contents

Overview Illustrations..... 10

Driver's Cockpit.....	11
Steering Wheel and Instrument Panel.....	12
Dashboard.....	13
Front Center Console.....	14
Overhead Operating Console.....	15
Rear.....	16

Opening and Locking 17

Never invite car theft!.....	18
Notes on the Key and Central Locking System.....	19
Central Locking System.....	20

Brief Overview – Opening and Locking

From Outside.....	21
Opening and Locking From Outside.....	22
Opening and Locking From Inside.....	31
Opening and Closing the Engine Compartment Lid.....	33
Malfunctions When Opening and Closing.....	35

Seats, Mirrors and Steering Wheel 37

Seat Adjustment and Head Restraints.....	38
Adjusting Front Seats.....	39
Storing Vehicle Settings.....	40
Easy Entry Function.....	42
Adjusting Rear Seats.....	42
Adjusting Passenger Seat From Rear.....	43
Front and Rear Heated Seats.....	43
Front and Rear Seat Ventilation.....	44

Safety Belts.....	44
Air bag Systems.....	47
Child Restraint Systems.....	52
LATCH Child Seat System.....	56
Exterior Mirrors.....	58
Steering Wheel.....	61
Heated steering wheel.....	61
Steering Wheel Adjustment.....	62
Multi-Function Steering Wheel.....	63
Sun Visors.....	64
Vanity Mirror.....	64
Roll-Up Sunblinds, Rear Side Windows.....	65
Roll-Up Sunblind, Rear Window.....	66

Air Conditioning 67

Brief Overview – Front Control Panel 68

Brief Overview – Rear Control Panel

(4-Zone Air-Conditioning).....	69
Overview of Air Conditioning.....	70
General Functions.....	71
Automatically Controlled Air Conditioning.....	76
Air Vents.....	82
Heated Rear Window/Exterior Mirror Heating.....	84

Windows and Slide/Tilt Roof..... 85

Power Windows.....	86
Slide/Tilt Roof.....	88

Lights, Turn Signals and Windshield Wipers..... 91

Automatic Driving Light Assistant/Adaptive Light System.....	92
Instrument lighting.....	95
Turn Signal/High Beam/Headlight Flasher Stalk.....	96
Emergency Flasher.....	97
Interior Lighting.....	98
Brief Overview – Windshield Wipers.....	101
Windshield Wiper/Washer Stalk.....	102

Instrument Panel and Multi-Function Display..... 105

Instrument Panel USA Models.....	107
Instrument Panel Canada Models.....	109
Tachometer.....	110
Speedometer.....	110
Multi-Function Display.....	110
Engine Oil Temperature Gauge.....	110
Coolant Temperature Gauge.....	110
Engine Oil Pressure Gauge.....	111
Fuel Gauge.....	111
Digital Speedometer.....	112
Upshift Prompt Indicator.....	112
Odometer.....	112
Reset Button for Trip Counter Display/Brightness Setting for Instrument Lighting....	112
PKD Display for Selector-Lever Position/Engaged Gear.....	112
Battery/Alternator.....	113

Check Engine (Emission Control).....	114	Sports Exhaust System	214	Locking the Steering Column	250
Acoustic Signals	114	Retractable Rear Spoiler.....	214	Theft Protection	250
Operating the Multi-Function Display in the Instrument Panel.....	115				
Vehicle Settings on the Multi-Function Display.....	138	Storage, Luggage Compartment and Roof Transport System	217	Maintenance and Car Care	251
Overview of Warning Messages.....	152	Storage.....	218	Exercise Extreme Caution when Working on your vehicle	252
		Drinks Holder/Cupholder	221	Engine Oil	254
Driving and Driving Safety	163	Front Ashtray.....	224	Checking Engine-Oil Level	254
Ignition Lock, Steering Lock	164	Rear Ashtray.....	224	Topping Up Engine Oil	255
Starting and Stopping the Engine	167	Cigarette Lighter.....	225	Checking Coolant Level and Adding Coolant	257
Auto Start Stop Function	169	Refrigerated box in the rear of the vehicle.....	226	Brake Fluid	258
Electric Parking Brake.....	171	Folding Rear Seats Forward and Returning to Upright Position	226	Washer Fluid	259
Brakes.....	172	Luggage Compartment.....	227	Power Steering	260
Cruise Control	176	Stowing Loads.....	228	Changing Air Cleaner	261
Adaptive Cruise Control.....	178	Luggage Compartment Cover	229	Changing Particle Filter.....	261
Car Audio Operation/Tips	189	Fixed Luggage Compartment Cover	231	Wiper Blades	261
Porsche Communication Management (PCM)	191	Ski Bag	231	Emission Control System	262
iPod®, USB and AUX.....	192	Roof Transport System	232	How Emission Control Works	263
Voice Control.....	192	Loading Information	236	Fuel Economy	264
Porsche Doppelkupplung (PDK).....	193			Operating Your Porsche in other Countries.....	264
Selector-Lever Positions	195	Parking	238	Fuel	265
Porsche Traction Management (PTM)	202	ParkAssist.....	239	Fuel Can	267
Porsche Stability Management (PSM).....	202	Rearview Camera.....	241	Fuel Recommendations.....	268
ABS Brake System (Anti-Lock Brake System)	207	Swivelling Down Mirror Glass as Parking Aid.....	242	Fuel Evaporation Control	269
Porsche Active Suspension Management (PASM).....	208	Garage Door Opener	243	Car Care Instructions.....	269
Porsche Active Suspension Management (PASM) with Air Suspension and Level Control	209			Minor Repairs	277
Porsche Dynamic Chassis Control (PDCC)	211	Alarm System and Theft Protection	246	Exercise Extreme Caution when Working on your Vehicle	278
“Sport” and “Sport Plus” Mode	212	Alarm System and Passenger Compartment Monitoring	247	Tires and Wheels.....	280
		Immobilizer.....	250	Wheel Bolts	293
				Flat Tire.....	293
				Electrical System	296

Battery.....	303
External Power Supply, Jump-Lead	
Starting.....	306
Changing the Remote Control Battery.....	307
Replacing Bulbs.....	308
Headlights.....	308
Side Turn Signal Light.....	312
Licence Plate Lights.....	313
Side Marker Light.....	313
Changing Light-Emitting Diodes and	
Long-Life Bulbs.....	314
Headlight Adjustment.....	314
Towing.....	316
Fire Extinguisher.....	321
Tire Pressure and Technical Data.....	322
Vehicle Identification Data.....	323
Engine Data.....	324
Wheels, Tires.....	325
Tire Pressure for Cold Tires (68 °F/20 °C)....	326
Weights.....	328
Filling Capacities.....	329
Driving Performance.....	329
Dimensions.....	330
Index.....	331

امداد خودرو فارما

تلفن شبانه روزی: ۰۲۱-۸۸۸۶۲۰۸۵

FarmaSOS.com

Overview Illustrations

Driver's Cockpit	11
Steering Wheel and Instrument Panel	12
Dashboard	13
Front Center Console	14
Overhead Operating Console	15
Rear	16

امداد خودرو فارما

تلفن شبانه روزی: ۰۲۱-۸۸۸۶۲۰۸۵

FarmaSOS.com

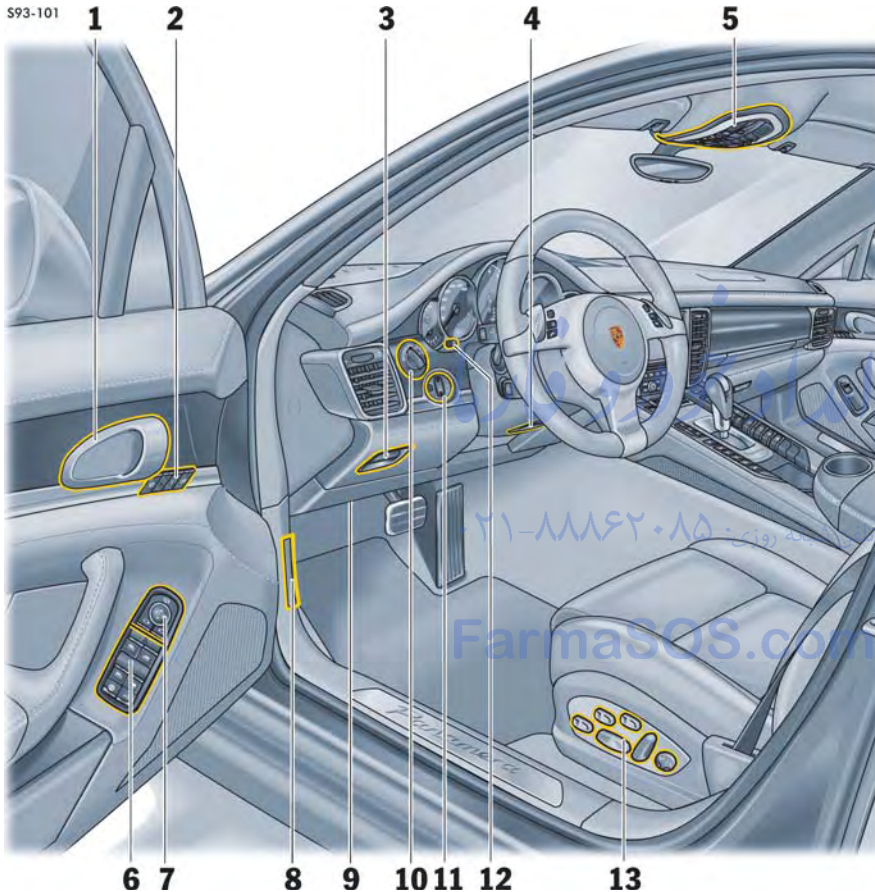

Driver's Cockpit

1. Door opener
See page 32.
2. Vehicle setting memory buttons
See page 40.
3. Electric parking brake
See page 171.
4. Steering wheel adjustment
See page 62.
5. Overhead operating console
See page 15.
6. Power windows
See page 86.
7. Exterior-mirror setting
See page 58.
8. Engine compartment lid release
See page 33.
9. Diagnostic socket (OBD)
10. Light switch
See page 92.
11. Ignition lock, steering lock
See page 164.
12. Dimming of instrument lighting
See page 95.
13. Seat adjustment
See page 39.

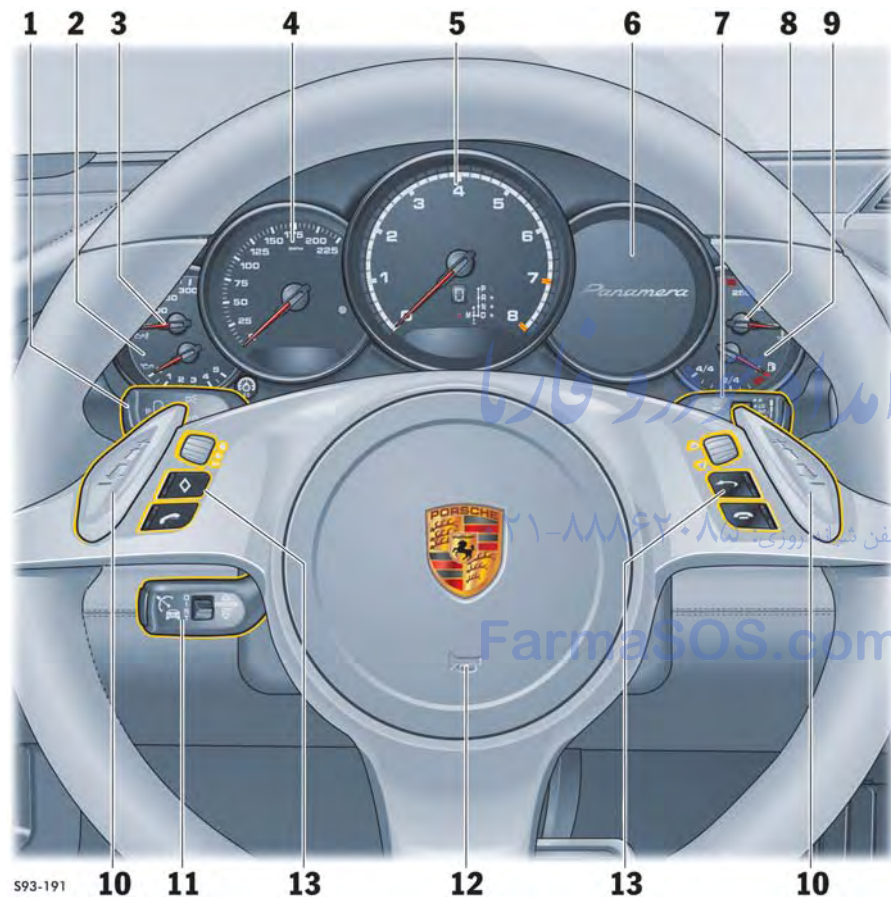

Steering Wheel and Instrument Panel

1. Turn signal lights
See page 96.
2. Engine oil pressure gauge
See page 111.
3. Engine oil temperature gauge
See page 110.
4. Speedometer
See page 110.
5. Tachometer
See page 110.
6. Multi-function display
See page 115.
7. Windshield wipers
See page 102.
8. Coolant temperature gauge
See page 110.
9. Fuel gauge
See page 111.
10. PDK shift buttons
See page 61.
11. Adaptive cruise control
See page 178.
12. Horn
See page 61.
13. Telephone controls, multi-function display
See page 115.

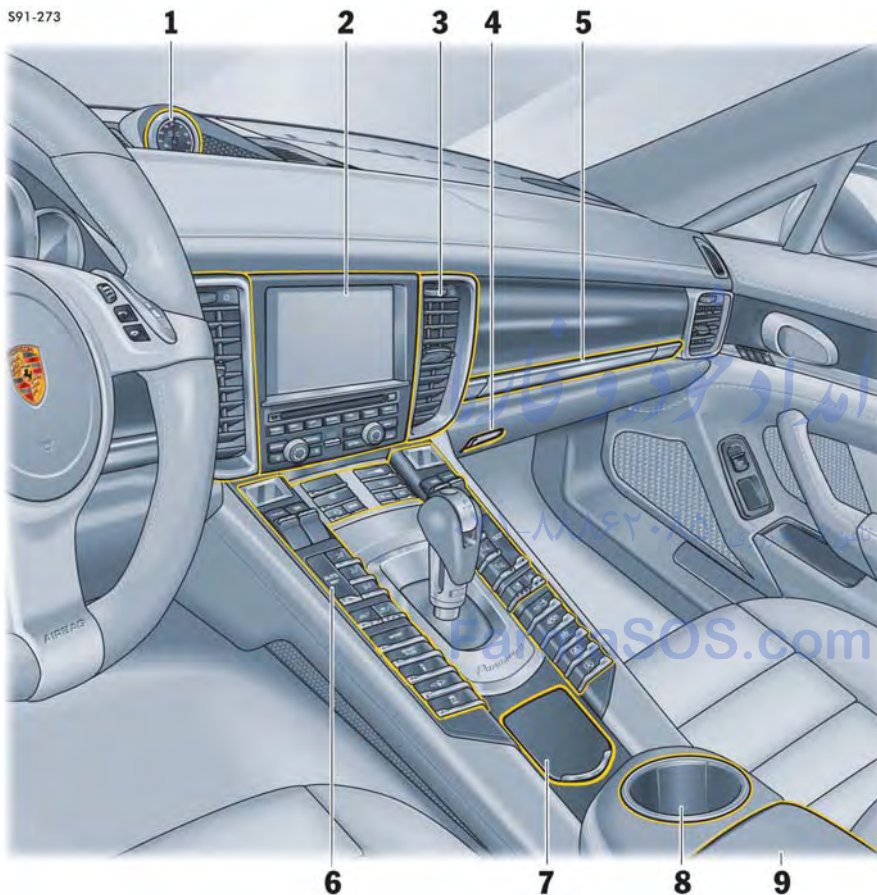

Dashboard

1. Sport Chrono clock
See page 135.
2. Porsche Communication Management (PCM)
See page 191.
3. Air vents
See page 82.
4. Glove box
See page 218.
5. Drinks holder/cupholder
See page 222.
6. Front center console
See page 14.
7. Ashtray, cigarette lighter
See page 224.
8. Drinks holder/cupholder
See page 222.
9. Armrest, storage compartment
See page 219.

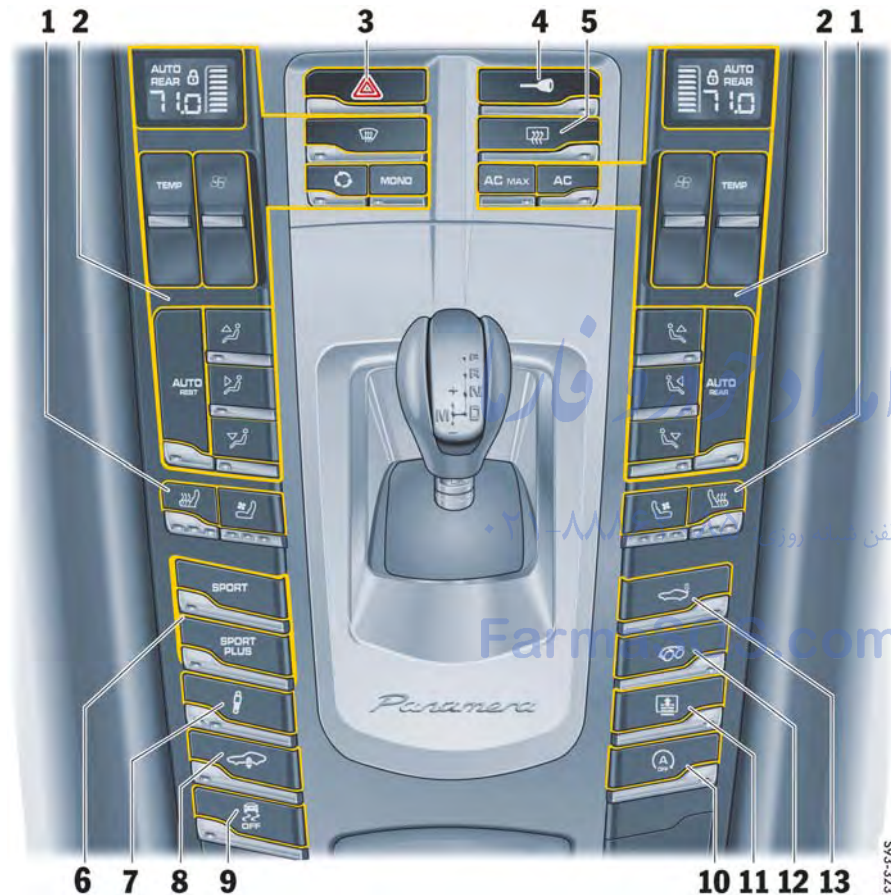

Front Center Console

1. Heated seats, seat ventilation
See page 43.
2. Air conditioning
See page 70.
3. Emergency flasher
See page 97.
4. Central locking
See page 31.
5. Heated rear window/external mirror heating
See page 84.
6. "Sport"/"Sport Plus" modes
See page 212.
7. Porsche Active Suspension Management (PASM)
See page 208.
8. High level
See page 210.
9. Porsche Stability Management (PSM)
See page 202.
10. Auto Start Stop function
See page 169.
11. Roll-up sunblind on rear window/rear side windows
See page 66.
12. Sports exhaust system
See page 214.
13. Retractable rear spoiler
See page 214.

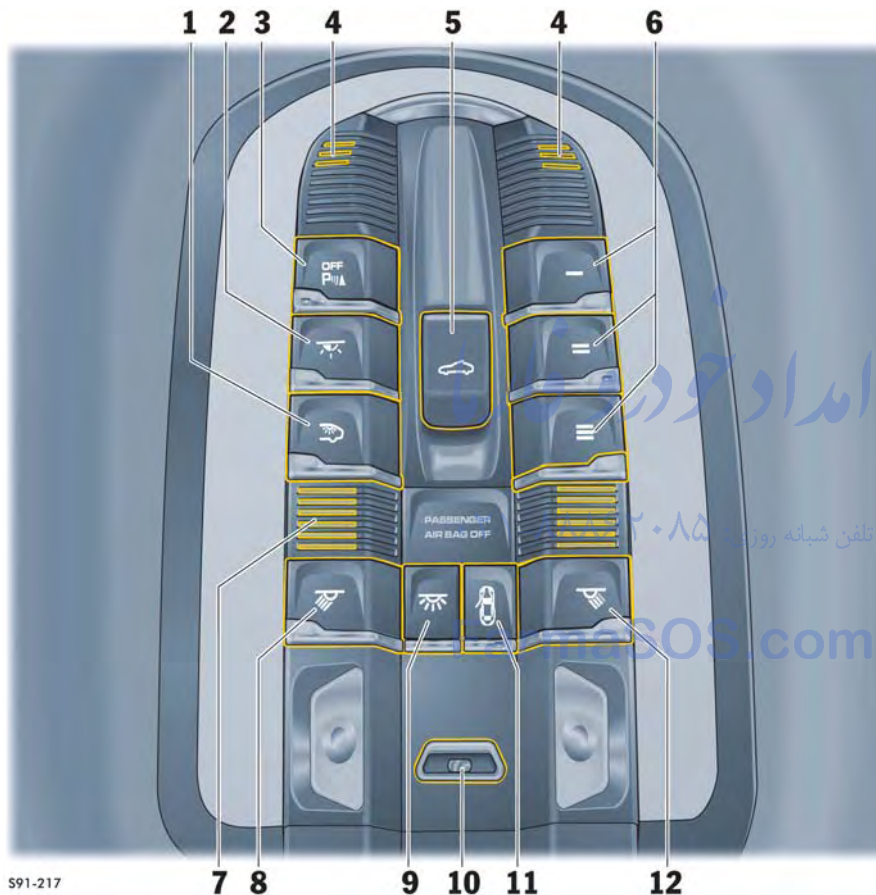

Overhead Operating Console

1. Rear interior lighting
See page 98.
2. Dimming ambient lighting
See page 100.
3. ParkAssist off button
See page 241.
4. Passenger compartment monitoring
See page 247.
5. Slide/tilt roof
See page 88.
6. Garage door opener/HomeLink®
See page 243.
7. Hands-free microphone
8. Reading light on driver's side
See page 98.
9. Front interior lighting
See page 98.
10. Orientation lighting
See page 99.
11. Interior door opening lighting
See page 99.
12. Reading light on passenger's side
See page 98.

S91-217

Rear

1. Interior light/reading light
See page 98.
2. Door opener
See page 32.
3. Air vents
See page 82.
4. Seat adjustment
See page 42.
5. Central locking
See page 31.
6. Air conditioning
See page 70.
7. Drinks holder/cupholder
See page 223.
8. Ashtray
See page 224.
9. Power window/roll-up sunblind on rear side windows
See page 86.

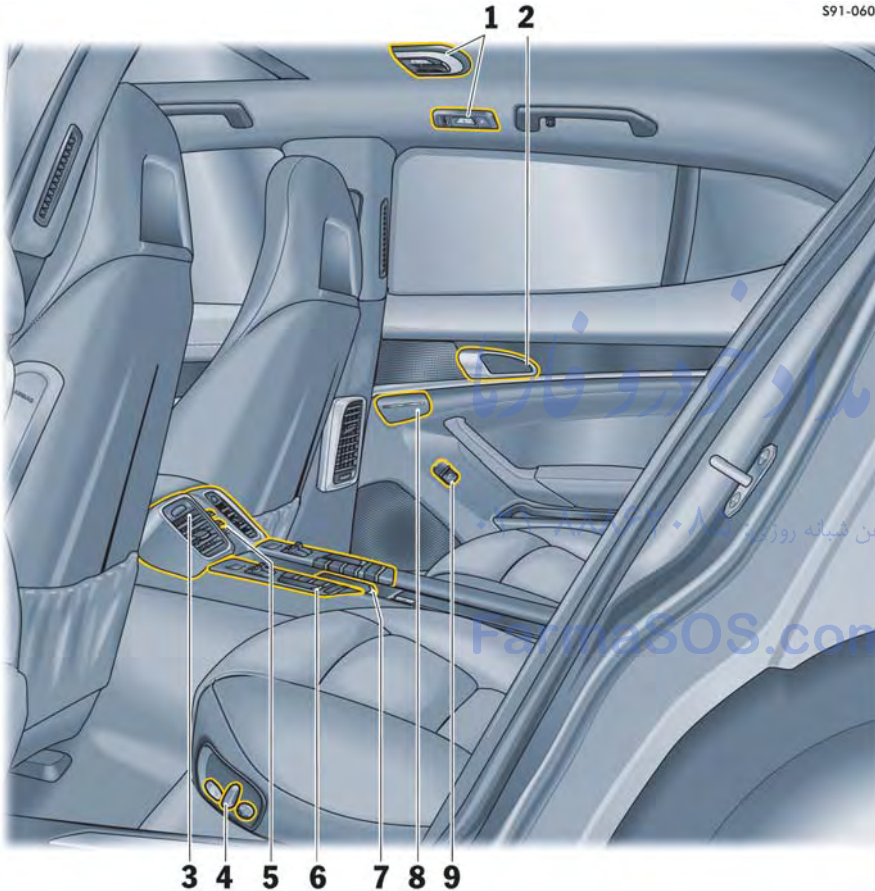

Opening and Locking

Never invite car theft!	18
Notes on the Key and Central Locking System	19
Central Locking System	20
Brief Overview – Opening and Locking	
From Outside	21
Opening and Locking From Outside	22
Opening and Locking From Inside	31
Opening and Closing the Engine Compartment Lid	33
Malfunctions When Opening and Closing	35

امداد خودرو فارما

تلفن شبانه روزی: ۰۲۱-۸۸۸۶۲۰۸۵

FarmaSOS.com

Never invite car theft!

An unlocked car with the key in the ignition lock invites car theft.

A steering wheel lock and a **gong alarm** are standard equipment in your Porsche. The gong alarm will sound if you open the driver's door while the key is still in the ignition lock. It is your reminder to pull the key out of the ignition lock and to lock the doors.

Warning!

Any uncontrolled movement of the vehicle may result in property damage, serious personal injury or death.

Never leave your vehicle unattended with the key in the ignition lock, especially if children and/or pets are left unattended in the vehicle. They can operate power windows and other controls. If the engine is left running, they may accidentally engage the shift lever. Serious personal injury or death could result from loss of control of the vehicle.

- ▷ Always remove the ignition key.
- ▷ Always set the electric parking brake.
- ▷ Lock the doors with the key or with the remote control.

Warning!

Risk of a serious accident. The steering column will lock when you remove the key while you are driving or as the car is rolling to a stop. You will not be able to steer the car.

Serious personal injury or death could result from loss of control of the vehicle.

- ▷ Never remove the key from the steering lock while you are driving.

To protect your vehicle and your possessions from theft, you should always proceed as follows when leaving your vehicle:

- ▷ Close windows.
- ▷ Close slide/tilt roof.
- ▷ Remove ignition key (switch ignition off in vehicles that have Porsche Entry & Drive).
- ▷ Engage steering lock.
- ▷ Remove valuables (e.g. car documents, radio control module, cell phones, house keys) from the car.
- ▷ Lock doors.
- ▷ Lock the glove compartment.
- ▷ Close storage trays.
- ▷ Cover luggage compartment with the luggage compartment cover.
- ▷ Close rear lid.

امداد خودرو فارما

تلفن شبانه روزی: ۰۲۱-۸۸۸۶۲۰۸۵

FarmaSOS.com

Notes on the Key and Central Locking System

Key

You are provided with two vehicle keys with integrated emergency key. These keys operate all the locks on your vehicle.

- ▷ Be careful with your vehicle keys: do not part with them except under exceptional circumstances.
- ▷ Remove and take the ignition key with you, even if leaving the vehicle only briefly. Do not leave the ignition key in the vehicle.
- ▷ Inform your insurance company of any loss or theft of car keys or if extra or replacement keys have been cut.
- ▷ Third parties can still operate the mechanical locks with a lost key.

Note on operation

Different vehicle settings are stored on the respective key when the vehicle is locked, provided the vehicle is fitted with the relevant equipment.

For information on storing vehicle settings on the key:

- ▷ Please see the chapter “STORING VEHICLE SETTINGS” on Page 40.

Emergency operation

- ▷ Please see the chapter “EMERGENCY OPERATION – UNLOCKING THE IGNITION KEY” on Page 166.

Replacement keys

Car keys can only be ordered through an authorized Porsche dealer. Sometimes, this may take a long time.

You should therefore always keep a spare key on your person. Keep it in a safe place, but under no circumstances in or on the vehicle.

The key codes of new keys have to be “reported” to the vehicle control module by an authorized Porsche dealer. All keys belonging to the vehicle must also be reported again.

Note – ۸۸۸۶۲۰۸۵ – تلفن شبانه روزی:

Third parties can continue to operate the mechanical locks using the lost key.

FarmaSOS.com



Panic button

In dangerous situations or when one's own safety is threatened, it is possible to draw attention to the situation by triggering an alarm.

To trigger an alarm

- ▷ Press button.
The horn sounds and the emergency flasher flashes.

To stop the alarm

- ▷ Press button again.
The horn becomes silent and the emergency flasher goes out.



Emergency key

Removing emergency key

1. Push the release button to the side.
2. Pull out the key.

Inserting emergency key

- ▷ Slide in the key until the release button audibly engages.

Central Locking System

USA: KR55WK50138

Canada: 7812D-5WK50138

This device complies with:
Part 15 of the FCC Rules
RSS-210 of Industry Canada.

Operation of this device is subject to the following two conditions:

- This device may not cause harmful interference, and
- this device must accept any interference received including interference that may cause undesired operation.

Note تلفن شبانه روزی: ۰۸۵-۲۰۶۲۸۸۶۲-۲۶

The manufacturer is not responsible for any radio or TV interference caused by unauthorized modifications to this equipment. Such modification could void the user's authority to operate the equipment.



Any changes or modifications not expressly approved by Porsche could void the user's authority to operate this equipment.

Your vehicle is equipped with a central locking system. The following are unlocked or locked together:

- Doors
- Rear lid
- Filler flap

The central locking system is always activated when the vehicle is unlocked and locked.

On the multi-function display of the instrument panel, you can set different variants for locking and unlocking the doors and rear lid. You can open all doors irrespective of the setting made.

The vehicle cannot be locked if the driver's door is not completely closed.

If one of the following components is not completely closed when you try to lock the vehicle the door/lid is not locked:

- vehicle doors
- rear lid
- engine compartment lid

The indication by the emergency flasher and by the acoustic signal will be provided after all doors and lids are closed.

Brief Overview – Opening and Locking From Outside

The Porsche Entry & Drive option can be recognized by the buttons **A** in the door handles.

This brief overview does not replace the information provided under “OPENING AND LOCKING FROM OUTSIDE”.

Warnings, in particular, are not replaced by this brief overview.





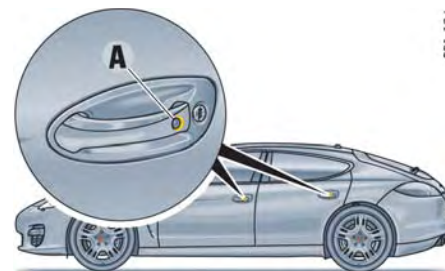

Key

S91-195



S91-194

Porsche Entry & Drive

What do I want to do?	What do I have to do?	What happens?
<p>Unlocking</p>	<p>Using the key: Press the button  on the key once. Press the button  on the key twice. With Porsche Entry & Drive: Grip the door handle fully.</p>	<p>The emergency flasher flashes once. The driver's door can be opened. All vehicle doors and the rear lid can be opened. The doors and the rear lid can be opened.</p>
<p>Closing</p>	<p>Using the key: Press the button  on the key. With Porsche Entry & Drive: Press the button A on the door handle.</p>	<p>The emergency flasher flashes twice and an acoustic signal will sound twice. The doors are locked.</p>
<p>Lock if persons/animals are remaining in vehicle (Switch off the alarm system's interior surveillance)</p>	<p>Please see the chapter “SWITCHING OFF INTERIOR SURVEILLANCE AND INCLINATION SENSOR” on page 247.</p>	
<p>Switching off alarm</p>	<p>Press the button  on the key.</p>	



Opening and Locking From Outside

Depending on your vehicle equipment, you can unlock and lock the vehicle either with the car key or without a key by means of Porsche Entry & Drive.

With the key

Use the buttons on the key to unlock and lock the vehicle.

S91-196

S91-197



Note on operation

The factory settings of the vehicle are described in this section.

In the multi-function display in the instrument panel, you can change the settings and store them on the respective key for vehicles with comfort memory.

For information on modifying the opening and locking settings:

- ▷ Please see the chapter “LOCKING SETTINGS” on page 145.

With Porsche Entry & Drive

On vehicles with Porsche Entry & Drive, you can unlock, lock and start the vehicle without using the key.

You simply have to carry the key with you, e.g. in your trouser pocket.

- ▷ Do not expose the car key to a high level of electromagnetic radiation. This could adversely affect Porsche Entry & Drive.



Unlocking and opening doors

Unlocking with the key

1. Press button .
The emergency flasher flashes once.
The driver's door is unlocked.
2. Pull the door handle.



Unlocking with Porsche Entry & Drive (keyless)

Either door can be unlocked if you position yourself on the side of the vehicle (driver's side, passenger's side) that you wish to open together with the key.

1. Grip the door handle fully.
The emergency flasher flashes once.
The doors are unlocked.
2. Pull the door handle.

Note on operation

The vehicle is locked automatically after 30 seconds if none of the doors or the tailgate is opened. The alarm system is not activated.

If the interior surveillance system and inclination sensor have been switched off (restricted anti-theft protection), this also remains the case after automatic relocking.

As a result, the doors can be opened from inside by pulling once on the front door opener or by pulling twice on the rear door opener.

- ▷ Inform any persons remaining in the vehicle that the alarm system will be triggered if the door is opened.

When locked again, the interior surveillance system and inclination sensor are activated once more.



Switching off operational readiness (for vehicles with Porsche Entry & Drive)

Operational readiness of Porsche Entry & Drive is switched off after 96 hours for the driver's door and after 36 hours for the passenger doors if the vehicle is not unlocked within this time.

1. Pull the door handle **once** to activate the system again.
2. Pull the door handle **again** to open the door.

Locking doors

Locking with the key

1. Close the door.
2. Press button  once.
The emergency flasher flashes twice and an acoustic signal will sound twice.
The doors cannot be opened from outside.
or
If persons or animals are remaining in the vehicle, press button  twice.
The emergency flasher flashes twice and an acoustic signal will sound twice.
The doors can be opened from inside by pulling once on the front door opener or by pulling twice on the rear door opener.
3. Inform any persons remaining in the vehicle that the alarm system will be triggered if the door is opened.

Note on operation for locking the doors with the key

The vehicle cannot be locked if the driver's door is not completely closed.
The emergency flasher indicates that the vehicle has been locked successfully only when all the doors, the engine compartment lid and the tailgate are closed.

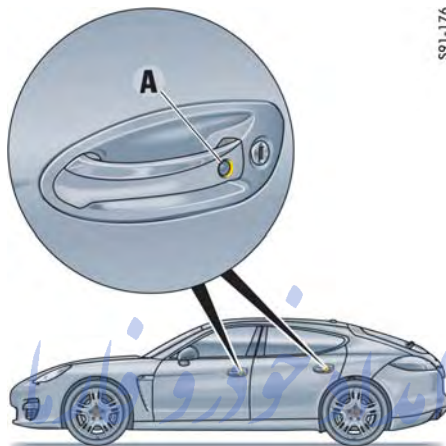

S91-176

The doors can be opened from inside by pulling once on the front door opener or by pulling twice on the rear door opener.

3. Inform any persons remaining in the vehicle that the alarm system will be triggered if the door is opened.

Note on operation for locking the doors with Porsche Entry & Drive (keyless)

- The vehicle cannot be locked if any of the doors or the tailgate are not completely closed.
A warning signal sounds in the passenger compartment and a warning message appears on the multi-function display.
- The key must be outside the vehicle when locking the vehicle doors, otherwise the vehicle doors cannot be locked.
- If the key is out of range, the vehicle doors can no longer be opened after they are locked.

Locking with Porsche Entry & Drive (keyless)

You must carry the key with you. تلفن شبانه روزی: 0212 222 2222

1. Close the door.
2. Briefly press the Porsche Entry & Drive locking button **A** on the door handle.
The emergency flasher flashes twice and an acoustic signal will sound twice.
The doors cannot be opened from outside.
or
If persons or animals are remaining in the vehicle, press the Porsche Entry & Drive locking button **A** on the door handle twice.
The emergency flasher flashes twice and an acoustic signal will sound twice.

Automatic door locking and automatic door unlocking



Warning!

In an emergency situation where you need to exit the car through an automatically locked door, remember the following procedure to open the door.

- ▷ Unlock the doors by pressing the central locking button **or**
- ▷ Pull the inside door handle on the front door once or on the rear door twice to open the door.

In the multi-function display of the instrument panel, you have the option of selecting diverse variants of automatic door locking and automatic door unlocking.

For information on modifying the opening and locking settings:

- ▷ Please see the chapter “LOCKING SETTINGS” on page 145.

S91-150



Unlocking and opening tailgate

When the tailgate is unlocked, the vehicle doors are also unlocked.

The vehicle is locked again automatically after 30 seconds if none of the vehicle doors or the tailgate is opened.



Danger!

Risk of carbon monoxide poisoning! Exhaust gases can enter the passenger compartment when the tailgate is open and render the occupants unconscious if longterm exposure occurs, resulting in an accident. In a stopped vehicle, carbon monoxide can also lead to death.

- ▷ Always keep the tailgate closed when the engine is running.
- ▷ Always keep the tailgate closed while driving.

Unlocking with the key

1. Press button .
2. Press the unlocking handle (**arrow**) on the tailgate and open the tailgate.

Unlocking with Porsche Entry & Drive (keyless)

Warning!

Risk of being locked out of vehicles with Porsche Entry & Drive.

- ▷ Do not leave the key in the vehicle if the vehicle is locked and access can be gained through the tailgate. The vehicle is automatically locked when the tailgate is closed.

If the key is left in the vehicle, the emergency flasher flashes once **and** a horn signal sounds. Within approximately 30 seconds, the tailgate can be opened by pressing the unlocking handle (**arrow**).

After 30 seconds have elapsed, the vehicle can be unlocked again only with the second key.

If you are in the rear area of the vehicle with the key and press the unlocking handle, the tailgate is unlocked.

- ▷ Press the unlocking handle on the tailgate and open the tailgate.

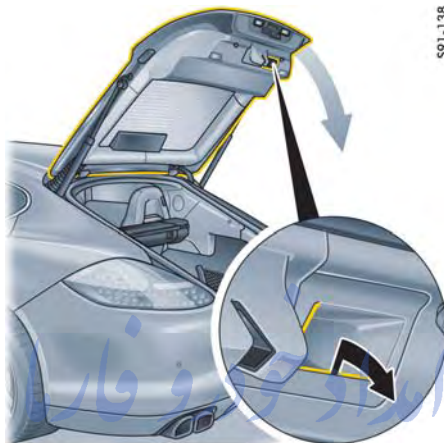

Locking the tailgate

Warning!

Danger of crushing. The tailgate automatically closes.

- ▷ Make sure that your fingers are not under the tailgate.
- ▷ Keep foreign objects or limbs away from moving parts (lock striker) of the power closing mechanism.
- ▷ Children must be kept away from the tailgate when closing. Children could be killed or severely injured by such a closing.

S91-138

The tailgate has a power closing mechanism.

1. Pull down the tailgate by means of the closing handle (**arrow**) and press gently into the lock. The tailgate is automatically pulled closed.
2. Briefly press button  on the key once. The vehicle is locked.

Note on operation

On vehicles with Porsche Entry & Drive, the tailgate can no longer be opened when the car key with remote control is out of range.

Powerlift tailgate

Opening and closing tailgate automatically



Warning!

Risk of poisoning! Exhaust gases can enter the passenger compartment when the tailgate is open.

- ▷ Always keep the tailgate closed when the engine is running.
- ▷ Always keep the tailgate closed while driving.

Risk of injury and damage if the tailgate is automatically opened or closed in an uncontrolled way!

- ▷ Do not leave children in the car unattended.
- ▷ Open or close the tailgate only when the vehicle is stationary.
- ▷ Never drive with the tailgate open. Exhaust gases can enter the passenger compartment.
- ▷ Open or close the tailgate only when there are no persons, animals or objects within its movement range.
- ▷ Always keep a close eye on the opening and closing operation so that movement can be stopped at any time in the event of danger.
- ▷ Make sure there is sufficient clearance behind and above the vehicle (e.g. roof transport systems, garage ceiling).

Acoustic indication during opening/closing of the tailgate

Opening and closing of the tailgate are indicated by warning tones.

You can have the warning tones activated/deactivated at your authorized Porsche dealer.

S91-150

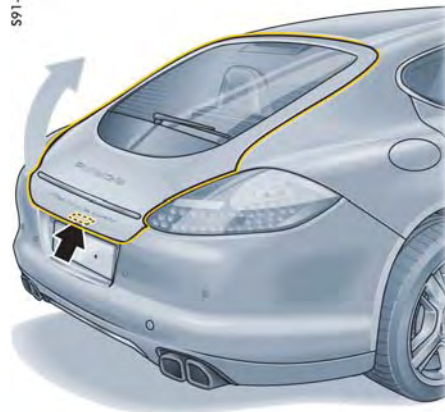

امداد خودرو فارما

تلفن شبانه روزی: ۰۲۱-۸۸۸۶۲۰۸۵

FarmaSOS.com

Opening tailgate automatically

There are **three** ways of opening the tailgate:

Variant 1

- ▷ Use the unlocking handle (**arrow**) on the tailgate. The vehicle must be unlocked for this. Vehicles with Porsche Entry & Drive need not be unlocked. You simply have to carry the car key with you, e.g. in your trouser pocket.



S91-198

Variant 2

- ▷ When the ignition is switched off, press the button  on the key for approximately 1 second. If the vehicle is locked, either the driver's door or the entire vehicle will be unlocked, depending on the settings in the multi-function display.

For information on locking and unlocking settings in the multi-function display:

- ▷ Please see the chapter "LOCKING SETTINGS" on page 145.



S91-014

Variant 3

- ▷ With the ignition switched on, press and hold the button  in the driver's door until the tailgate has opened fully. Opening is interrupted if the button is released prematurely.

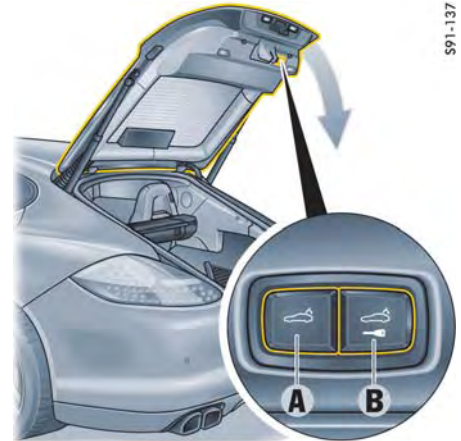

S91-137

A – Closing the tailgate automatically without Porsche Entry & Drive

A and **B** – Closing the tailgate automatically and locking with Porsche Entry & Drive

Closing tailgate automatically

Make sure that the load is not in the area of the tailgate when the tailgate is closed because otherwise the closing operation will be interrupted after contact with the load and the tailgate will open again.

- ▷ Press the button **A** in the trim panel on the tailgate. The tailgate is closed.

Close the tailgate automatically and lock with Porsche Entry & Drive.

- ▷ Press the button **B** in the trim panel on the tailgate.
The tailgate is closed and the vehicle is locked.

In order to close and then lock the tailgate on the vehicle automatically, the key must be located:

- in the rear area **and**
- outside the vehicle.

A warning message appears on the multi-function display in the instrument panel if these conditions have not been met.

For information on warning messages on the multi-function display:

- ▷ Please see the chapter “OVERVIEW OF WARNING MESSAGES” on page 152.



Warning!

Risk of being locked out of vehicles with Porsche Entry & Drive.

- ▷ Do not leave the key in the vehicle.
If locking button **B** is pressed after the tailgate has closed, the vehicle is locked automatically. If the key is left in the vehicle, the emergency flasher flashes once **and** a horn signal sounds. Within approximately 30 seconds, the tailgate can be opened again.
After 30 seconds have elapsed, the vehicle can be unlocked again only with the second key.

Interrupting the opening/closing operation in the event of danger

The opening or closing operation is interrupted immediately after:

- ▷ Pressing button  on the key
or
Releasing button  in the driver's door
or
Briefly pressing button **A** or **B** in the trim panel on the tailgate
or
Briefly pressing the release button on the tailgate.

Automatic operation can be continued again at any time. To do this, press the corresponding button.



Caution!

Risk of damage to the tailgate caused by striking garage roofs or roof transport systems. If the luggage compartment cover is not attached to the tailgate, the tailgate continues to move slowly upwards beyond the automatic stop.

- ▷ Only use the powerlift tailgate with the luggage compartment cover attached.

Detection of obstacles during opening

The tailgate will stop moving if opening is blocked by an obstacle. A warning signal then sounds. The opening operation can continue once the obstacle is removed and after:

- ▷ Pressing button  on the key
or
Pressing button  in the driver's door
or
Pressing the release button on the tailgate.

Detection of obstacles during closing



Warning!

Danger of crushing.

- ▷ Despite the presence of this detection system, you are still responsible for keeping yourself and others entirely out of the way of the door as it is closing.

The closing operation is interrupted if closing of the tailgate is blocked by an obstacle. A warning signal sounds and the tailgate opens again.

When the obstacle has been removed, the tailgate can be closed by pressing the button in the tailgate trim panel.

Automatic stop in the event of unintentional tailgate movement

If the tailgate is moved too abruptly or lowers unaided immediately after opening, e.g. due to the weight of snow, an electrical mechanism brakes the tailgate and a series of brief warning signals sounds until the tailgate stops moving.

- ▷ Bring the tailgate to rest for approx. 1 second. The braking function is deactivated.

Adjusting the opening height of the tailgate

The opening height of the tailgate can be individually adjusted so that the tailgate does not collide with the garage ceiling, for example. On vehicles with level control, the vehicle height changes according to the level control setting.

- ▷ Always adjust the opening height with the vehicle at the highest level setting so that the tailgate cannot accidentally collide with the garage ceiling, for example.

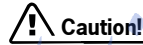

Caution!

Risk of damage to the tailgate. If the luggage compartment cover is not attached to the tailgate, the tailgate continues to move slowly upwards beyond the automatic stop.

- ▷ Only use the powerlift tailgate with the luggage compartment cover attached.

1. Stand behind the vehicle and open the tailgate.
2. Press button  on the key to stop the automatic opening operation at around 2/3 of the opening height.
3. Now move the tailgate up by hand until the desired opening height is reached. Make sure that there is a sufficient minimum clearance from any obstacle.

4. Press the button **A** in the trim panel on the tailgate for approximately 3 seconds. An acknowledgement signal sounds. The opening height of the tailgate has now been programmed. The tailgate can now be closed by briefly pressing the button.

This setting cannot be deleted. If a different setting is required, repeat steps 1 to 4.

Malfunctions of the tailgate drive

The automatic function is not active if the battery voltage is too low.

If a button is pressed, the tailgate lock is unlocked and three brief warning signals sound. The tailgate can now be opened by hand.

- ▷ Charge the vehicle battery.

Emergency operation of tailgate

If the automatic opening or closing operation is interrupted by a fault:

- ▷ Slowly open or close the tailgate by hand.

Overload protection

If overloading of the tailgate drive is detected, three brief warning signals sound. The tailgate cannot be operated automatically for approx. 30 seconds.

Opening and Locking From Inside

The factory settings of the vehicle are described in this section.

In the multi-function display in the instrument panel, you can change the settings and store them on the respective key for vehicles with comfort memory.

For information on modifying the opening and locking settings:

- ▷ Please see the chapter "LOCKING SETTINGS" on page 145.



Front central locking button

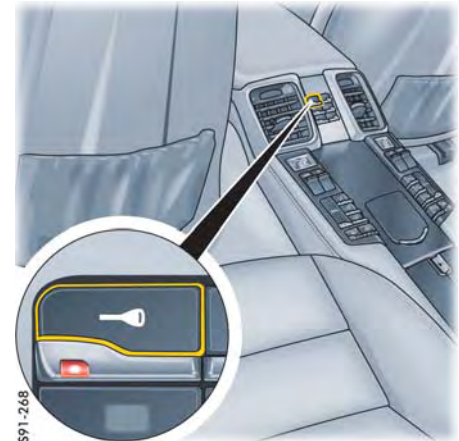

Rear central locking button



Locking doors

- ▷ Press the front or rear central locking button. When the ignition is switched on, the indicator light in the button lights up.

All vehicle doors will be locked.

The doors can be opened from inside by pulling once on the front door opener or by pulling twice on the rear door opener.

Automatic with Auto Lock

If this function is activated, the vehicle is locked automatically when a speed of approximately 2 mph (5 km/h) is exceeded.

For information on modifying the opening and locking settings:

- ▷ Please see the chapter "LOCKING SETTINGS" on page 145.

🔑 Unlocking doors

- ▷ Press the front or rear central locking button. The indicator light on the button goes out. **All** vehicle doors will be unlocked.

Automatic with Auto Unlock

The vehicle is automatically unlocked when the ignition key is removed.

Note on operation

If the vehicle was locked by remote control or with the key, it cannot be unlocked with the central locking button.



Securing rear doors

You can prevent passengers from accidentally pulling the door opener and opening the rear doors from inside.

Opening doors

Opening unlocked doors

- ▷ Pull door opener (**arrow**) once.

Opening locked doors

- ▷ Pull once on the front door opener (**arrow**) or twice on the rear door opener.



Opening and Closing the Engine Compartment Lid



Danger!

Risk of loss of control or an accident, resulting in serious personal injury or death.

- ▷ Should you notice at any time while driving that one of the lids is not secured properly, please stop immediately in a suitable place and close it.
The engine compartment lid may fly up impairing vision.

Opening



Caution!

Risk of damage to engine compartment lid or windshield wipers.

- ▷ Make sure that the windshield wipers are not pulled out forwards when opening the engine compartment lid.
- ▷ Always switch off windshield wipers before opening the engine compartment lid (wiper switch in position **O**).

For information on the front wipers:

- ▷ Please see the chapter "FRONT WIPER AND HEADLIGHT WASHER SYSTEM" on page 102.

Activating and deactivating child lock

The child locks are fitted in the lock area of the rear doors.

The doors cannot be opened from inside when the child locks are on.

- ▷ To engage: Turn the child lock in direction of travel using the emergency key.
- ▷ To disengage: Turn the child lock away from the direction of travel using the emergency key.

For information on the emergency key:

- ▷ Please see the chapter "EMERGENCY KEY" on page 20.

امداد خودرو فارما

تلفن شبانه روزی: ۰۲۱-۸۸۸۶۲۰۸۵

FarmaSOS.com



1. Open the driver's door.
2. Pull the release lever (**arrow**).
The engine compartment lid is now unlocked.



3. Pull the unlocking handle (**arrow**).
 4. Open the engine compartment fully.
- تلفن شبانه روزی: ۰۲۱-۸۸۸۸۸۸۸۸

Closing

1. Lower lid and let it fall into the lock. If necessary, push the lid closed with the palm of your hand in the area of the lock.
2. Check that the lid is engaged correctly in the lock and that the release lever is back in its initial position.

When the vehicle is in motion, a message will appear on the multi-function display in the instrument panel if the lid is not closed properly.

FarmaSOS.com

Malfunctions When Opening and Closing

Emergency operation of tailgate

If the tailgate cannot be opened with the radio remote control (e.g. if the battery of the remote control is dead), the emergency operation must be performed:

1. Unlock and open the driver's door with the car key.
2. **Switch on the ignition within 10 seconds to prevent the alarm system from triggering.**
3. Press the central locking button on the front or rear center console.
The tailgate is now unlocked and can be opened with the unlocking handle.

Only one door is unlocked

On the multi-function display in the instrument panel, you can set different variants for locking and unlocking the doors and tailgate. You can open all doors irrespective of the setting made.

- ▷ Press button  on the key twice within 2 seconds.

The vehicle cannot be unlocked

The remote control of the key may

- not function correctly due to radio waves (also radio contact between remote control and vehicle in the case of Porsche Entry & Drive),
 - fail due to a fault,
 - fail due to a flat key battery.
- ▷ Unlock the vehicle using the emergency key in the door lock.
If the vehicle was unlocked using the emergency key in the door lock, only the driver's door can be opened.
In order to prevent the alarm system from being triggered, switch the ignition on within 10 seconds of opening the door.

The vehicle cannot be locked

This is recognizable by the fact that the emergency flasher does not flash and there is no locking noise.

The remote control of the key may

- not function correctly due to radio waves (also radio contact between remote control and vehicle in the case of Porsche Entry & Drive),
 - fail due to a fault,
 - fail due to a flat key battery.
- ▷ Lock the vehicle using the emergency key in the door lock.

If the central locking system is defective, operating the lock cylinder in the driver's door will lock all functioning locking elements of the central locking system.

For information on locking the doors by means of the emergency operation:

- ▷ Please see the chapter "NOT ALL VEHICLE DOORS ARE LOCKED" on page 36.
- ▷ Have faults in the central locking system repaired.
Please contact a qualified specialist workshop. We recommend that you have an authorized Porsche dealer to do this work as they have trained workshop personnel and the necessary parts and tools.

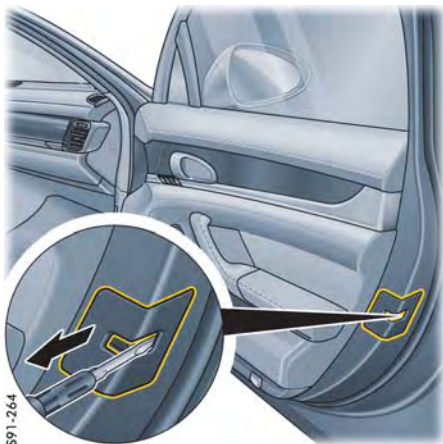

Not all vehicle doors are locked

The central locking system has failed. The doors must be locked using the emergency operation function.

1. Open the passenger's door.
2. Unclip cover and remove.



3. Turn the lock outward using the emergency key.

For information on the emergency key:

- ▷ Please see the chapter "EMERGENCY KEY" on page 20.
4. Fit the cover again.
 5. Repeat procedure at the rear doors.
 6. Close all doors.



7. Lock the driver's door with the emergency key in the door lock.

The doors can be opened from inside by pulling the door opener.

Seats, Mirrors and Steering Wheel

Seat Adjustment and Head Restraints	38
Adjusting Front Seats	39
Storing Vehicle Settings.....	40
Easy Entry Function.....	42
Adjusting Rear Seats	42
Adjusting Passenger Seat From Rear	43
Front and Rear Heated Seats	43
Front and Rear Seat Ventilation	44
Safety Belts	44
Air bag Systems.....	47
Child Restraint Systems.....	52
LATCH Child Seat System	56
Exterior Mirrors.....	58
Steering Wheel.....	61
Heated steering wheel	61
Steering Wheel Adjustment	62
Multi-Function Steering Wheel	63
Sun Visors	64
Vanity Mirror	64
Roll-Up Sunblinds, Rear Side Windows.....	65
Roll-Up Sunblind, Rear Window	66

امداد خودرو فارما

تلفن شبانه روزی: ۰۲۱-۸۸۸۶۲۰۸۵

FarmaSOS.com

Seat Adjustment and Head Restraints



Danger!

The seat may move unexpectedly if you attempt to adjust while driving. This could cause sudden loss of control, resulting in serious personal injury or death.

- ▷ Do not adjust seats while the vehicle is in motion. The backrest locks must be engaged at all times while the vehicle is in motion.

Safety belts only offer protection when the backrest is upright and the belts are properly positioned on the body.

Improperly positioned safety belts or safety belts worn by passengers in an excessively reclined position can cause serious personal injury or death in an accident.

- ▷ Do not operate the car with the driver or passenger backrests excessively reclined.
- ▷ Please see the chapter "SEAT POSITION" on page 38.

Danger of injury if persons or animals are in the movement range of the seat during seat adjustment.

- ▷ Adjust the seat so that no-one is put at risk.
- ▷ Do not activate the comfort memory button if there is any risk of the seat crushing the occupant.

- ▷ Cancel automatic adjustment by pressing any of the seat adjustment buttons.
- ▷ Do not leave children in the vehicle unattended, since they may depress the comfort setting button and crush themselves or another occupant.



Caution!

Risk of damage to windshield, sun visor, windstop, etc. when the seat is adjusted or folded back or forward.

- ▷ Adjust the seat so that the seat backrest is not in contact with any other object.

The driver, front, and back passenger seats provide integrated head restraints in the backrests. The head restraints are not adjustable.



Warning!

All occupants, including the driver, should not operate a vehicle or sit in a vehicle's seat until the head restraints and backrests, respectively, are placed in their proper positions so that the risk of neck injuries is minimized in the event of a crash.

For a proper positioning of the head restraint, the seatback's inclination should be adjusted such that the head restraint is in an upright position. Driver and passengers should be seated upright and in the center of their seats.

Seat position

An ergonomically correct sitting position is important for safe and fatigue-free driving. We recommend the following procedure for adjusting the driver's seat to suit individual requirements:

1. Adjust the seat until, with your left foot on the footrest, your left leg remains at a slight angle.
2. Rest your outstretched arm on the steering wheel. Set the backrest angle and the steering wheel position so that your wrist rests on the outer rim of the steering wheel. At the same time, the shoulders must still be in noticeable contact with the backrest.
3. Adjust the seat height to give yourself enough headroom and a good overview of the vehicle.
4. Electrically adjustable seat: Adjust the seat angle until your thighs rest lightly on the seat cushion.

Adjusting Front Seats

Adjusting the seat



Warning!

Risk of accidents. The seat may move further than desired if you attempt to adjust it when driving. You may lose control of the vehicle.

- ▷ Do not adjust the seat when driving.

Danger of injury if persons or animals are in the movement range of the seat during seat adjustment.

- ▷ Adjust the seat so that no-one is put at risk.



A Seat angle adjustment.

B Seat height adjustment. تلفن شبانه روزی: ۰۲۱-۸۸۸۸۸۸۸۸

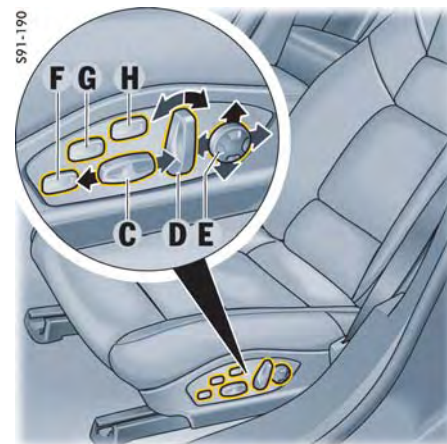

C Fore-and-aft adjustment.

D Backrest angle adjustment.

E Lumbar support adjustment (backrest curvature for pelvic and spinal column support).

F Seat cushion depth adjustment.

G Seat cushion side bolster adjustment.

H Backrest side bolster adjustment.

- ▷ Press each control in the direction indicated by the **arrows** until the desired setting is reached.

FarmaSOS.com



Driver's door memory buttons (driver memory or comfort memory)

Storing Vehicle Settings

Driver memory

The current seat, exterior-mirror and steering wheel settings are stored automatically on the car key when the vehicle is locked.

Personal position settings for the driver's seat, exterior mirrors and the steering wheel can also be stored in the person buttons **2** and **1** in the driver's door and retrieved at any time by pressing the buttons.

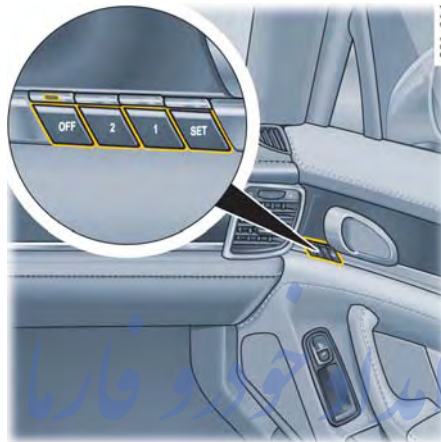

Passenger's door memory buttons (comfort memory)

Comfort memory

On vehicles with the comfort memory package, different vehicle settings, such as the multi-function display, are stored on the car key and the person buttons **1** and **2** in the driver's door in addition to the driver memory settings.

Personal position settings for the passenger seat can be stored on the person buttons **1** and **2** in the passenger's door.

The passenger seat settings are not stored on the car key.

Warning!

Risk of crushing due to uncontrolled activation of settings.

- ▷ Do not activate the comfort memory button if there is any risk of the seat crushing the occupant.
- ▷ Cancel automatic adjustment by pressing any of the seat adjustment buttons.
- ▷ Do not leave children in the vehicle unattended, since they may depress the comfort setting button and crush themselves or another occupant.

Preventing automatic storage of settings on car key

Deactivating automatic storage

- ▷ Press the button **OFF** before leaving the vehicle.
The indicator light on the button lights up. The current settings are stored on the vehicle key.
All settings that are modified when the **OFF** function is active are not stored on the vehicle key.

Activating automatic storage

- ▷ Press button **OFF** briefly.
or
Press and hold the button **OFF** until the settings last stored on the car key are retrieved.
The indicator light on the button goes out. Automatic storage is activated.

Storing settings on person buttons 1 and 2

Storing seat, steering wheel and mirror settings while driving is not possible.

Storing settings

1. Make the required adjustments to the mirror, steering wheel (person buttons on the driver's side only) and seat settings.
2. Press memory button **SET**.
The indicator light on the button lights up.
3. Press one of the person buttons **1** or **2** within 10 seconds.
The indicator light on the memory button **OFF** goes out and an acknowledgement signal sounds.
The settings are now stored on the desired person button.

Retrieving settings using the car key or on vehicles with Porsche Entry & Drive

- ▷ Open the driver's door.
The seat positions that were last set are restored automatically.

Cancelling settings

Automatic settings can be cancelled by pressing the button **OFF** or the button  on the car key.

Retrieving settings with person buttons 1 and 2

Driver's side

1. Open the door.
2. Press person button **1** or **2**.
or
once the door is closed or the ignition key is inserted and the ignition is switched on (on vehicles with Porsche Entry & Drive), press and hold the person button **1** or **2** until the stored positions have been reached.

Passenger's side

- ▷ Press and hold the person button **1** or **2** on the passenger's side until the stored positions have been reached.

Cancelling settings

Automatic settings can be cancelled by pressing the button **OFF**.

Easy Entry Function

The Easy Entry function makes it easier for you to get in and out of the vehicle.

Warning!

Risk of crushing if persons are behind the driver's seat when settings are retrieved.
Risk of damage if the rear seat bench is folded forward when settings are retrieved.

- ▷ Switch off the Easy Entry function if there are persons behind the driver's seat or if the rear seat bench is folded forward.

Prerequisite

- Function must be activated on the multi-function display.

For information on switching the Easy Entry function on and off:

- ▷ Please see the chapter "SWITCHING COMFORT ENTRY ON AND OFF" on page 145.

Entering the vehicle

When the driver's door is opened, the steering wheel and passenger seat move upwards or to the rear depending on the position of the seat and steering wheel when the driver left the vehicle.

Once the driver's door is closed and the ignition key is inserted or, in the case of vehicles with Porsche Entry & Drive, the ignition is switched on, the seat and steering wheel move to the stored position.

Exiting the vehicle

The steering wheel moves upwards:

- After the ignition key is removed **or**
- After the ignition is switched off **and** the driver's door is opened on vehicles with Porsche Entry & Drive.

The driver's seat moves to the rear: تلفن شبانه روز: ۰۲۱ ۸۸۸۶۵۰۰۰

- After the driver's door is opened.

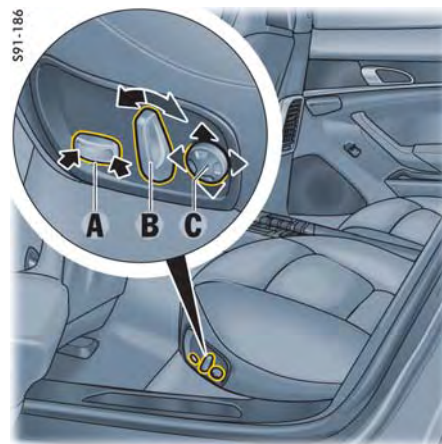

Adjusting Rear Seats

- A Seat cushion depth adjustment.
- B Backrest angle adjustment.
- C Lumbar support adjustment (backrest curvature for pelvic and spinal column support).

- ▷ Press each control in the direction indicated by the **arrows** until the desired setting is reached.

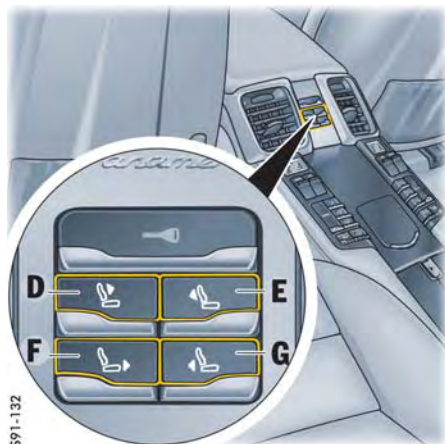

Adjusting Passenger Seat From Rear

- D Adjusting backrest angle **forward**
 - E Adjusting backrest angle **to the rear**
 - F Adjusting seat **forward and upwards**
 - G Adjusting seat **to the rear and downwards**
- ▷ Press the button until the desired setting is reached.

Adjustment of the passenger seat from the rear control panel can be interrupted at any time by pressing one of the adjustment buttons on the passenger seat.

! Caution!

Risk of damage. When using a child restraint system on the passenger's seat, the seat or the seat belt may be damaged if the passenger's seat is adjusted.

- ▷ If a child restraint system is installed on the passenger's seat, do not adjust the seat.

For information on child restraint systems:

- ▷ Please see the chapter "CHILD RESTRAINT SYSTEMS" on page 52.

امداد خودرو فارما

تلفن شبانه روزی: ۰۲۱-۸۸۸۶۲۰۸۵

FarmaSOS.com

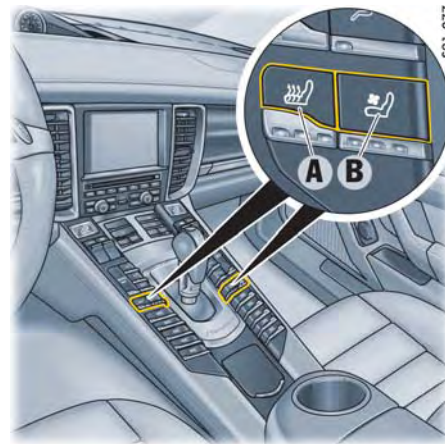

Front and Rear Heated Seats

The heated seats are ready for operation when the ignition is on. The heating power can be adjusted to one of three settings by repeatedly pressing the heated seat button **A**.

Switching on

- ▷ Press the heated seat button **A** (repeatedly). The number of illuminated lights indicates the selected heat setting.

Switching off

- ▷ Press the heated seat button **A** repeatedly until all the indicator lights go out.



Front and Rear Seat Ventilation

The seat ventilation is ready for operation when the ignition is on. The seat ventilation can be adjusted to one of three settings by repeatedly pressing the seat ventilation button **B**.

Switching on

- ▷ Press the seat ventilation button **B** (repeatedly).
The number of illuminated lights indicates the selected ventilation setting.

Switching off

- ▷ Press the seat ventilation button **B** repeatedly until all the indicator lights go out.

Notes

Seat heating is not available when the interior temperature is high.
Seat ventilation is not available when the interior temperature is low.

امداد خودرو فارما

تلفن شبانه روزی: ۰۲۱-۸۸۸۶۲۰۸۵

FarmaSOS.com

Safety Belts



Danger!

Always make sure your and your passengers' safety belts are properly fastened seated in the vehicle.

Failure to follow safety belt warnings may result in serious personal injury or death.

- ▷ For your and your passengers' protection, use safety belts at all times while the vehicle is in motion.
- ▷ Use appropriate child restraint systems for all small children.

Proper wearing of safety belts

- ▷ Safety belts must be positioned on the body as to restrain the upper body and lap from sliding forward. Improperly positioned safety belts can cause serious personal injury in case of an accident.
- ▷ The shoulder belt should always rest on your upper body. The shoulder belt should never be worn behind your back or under your arm.
- ▷ For maximum effectiveness, the lap belt should be worn low across the hips.
- ▷ Pregnant women should position the belt as low as possible across the pelvis. Make sure it is not pressing against the abdomen.
- ▷ Belts should not be worn twisted.

- ▷ Do not wear belts over rigid or breakable objects in or on your clothing, such as eye glasses, pens, keys, etc. as these may cause injury.
- ▷ Several layers of heavy clothing may interfere with proper positioning of belts.
- ▷ Belts must not rub against sharp objects or damage may occur to the belt.
- ▷ Two occupants should never share the same belt at the same time.

Care and maintenance

- ▷ Keep belt buckles free of any obstruction that may prevent a secure locking.
- ▷ Belts that have been subjected to excessive stretch forces in an accident must be inspected or replaced to ensure their continued effectiveness in restraining you. The same applies to belt tensioner systems which have been triggered. In addition, the anchor points of the belts should be checked.
- ▷ If safety belts do not work properly, see your authorized Porsche dealer immediately.
- ▷ If the belts show damage to webbing, bindings, buckles or retractors, they should be replaced to ensure safe operation.
- ▷ Do not modify or disassemble the safety belts in your vehicle.

- ▷ The belts must be kept clean or the retractors may not work properly.
Please see the chapter “CAR CARE INSTRUCTIONS” on page 269.
- ▷ Never bleach or dye safety belts.
- ▷ Do not allow safety belts to retract until they are completely dry after cleaning or this may cause damage to the belt.

Belt tensioner

Depending on the force of a collision, fastened seat belts are automatically tightened in an accident.

The belt tensioners are triggered in:

- Front and rear impacts of sufficient severity
- Side impacts
- In cases of vehicle rollover

Maintenance notes

The belt tensioner system can be triggered only once; the system must be replaced afterwards.

If there is a fault in the belt tensioner system, the air bag warning light lights up.

Work may be performed on the belt tensioner system only by an authorized Porsche dealer. Smoke is released when the belt tensioners are triggered.

This does not indicate a fire in the vehicle.

Safety Belt Warning System

An audio-visual warning system is interconnected with the driver's safety belt.

Every time the ignition is turned on, the gong will sound for about 6 seconds to remind driver and passenger to buckle up. In addition, the gong will sound for approximately 90 seconds if vehicle speed exceeds 15 mph (24 km/h).

The safety belt warning lights in the instrument panel and multi-function display will go off as soon as the driver has buckled up.

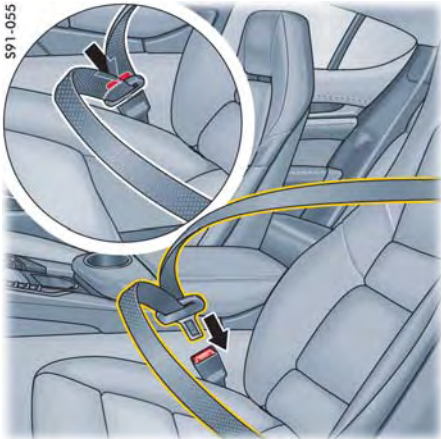

Fastening the safety belt

- ▷ Assume a comfortable sitting position. Adjust the backrest of the front seat so that the belt always rests on your upper body and runs across the middle of your shoulder.
- ▷ Grasp the belt tongue and pull the belt in a slow, continuous motion across your chest and lap.

Note on operation

The belt can be blocked if the vehicle is standing at an angle or if the belt is pulled out using a jerking movement.

- ▷ The belt cannot be pulled out while accelerating and slowing down, when cornering and when driving uphill.
- ▷ Insert the belt tongue into the appropriate buckle on the inboard side of the seat, until it locks securely with an audible click.
- ▷ Make sure that belts are not trapped or twisted, and that they are not rubbing on sharp edges.
- ▷ The horizontal section of the belt should always fit snugly across the pelvis. Therefore, after fastening the belt, always pull the diagonal part of the belt upwards. Pregnant women should position the belt as low as possible across the pelvis, and ensure that it is not pressing against the abdomen.
- ▷ Pull on the diagonal section of the belt now and again during the journey to ensure that the horizontal section remains tight.
- ▷ Make sure that the belts and buckles fit correctly on the rear seat bench.

Releasing the safety belt

- ▷ Hold the belt tongue.
- ▷ Press the red button (**arrow**).
- ▷ Guide belt tongue to the reel.



Safety belt height adjustment

The heights of the belt deflectors for the driver's seat, passenger's seat and the rear seats can be adjusted.

Adjust the height of the safety belt so that it runs across the middle of the shoulder, not against the neck.

Adjusting belt height

- ▷ Upward – push belt deflector up.
- ▷ Downward – press button **A** and move belt deflector.

Air bag Systems

The vehicle is equipped with air bag and lap/shoulder belt at both front seating positions. The air bag is a supplemental restraint at those seating positions.

The air bags in combination with the safety belts make up a safety system which offers the driver and the passenger the greatest known protection from injuries in case of accident.

Your vehicle is equipped with occupant sensing for the passenger's seat in accordance with U.S. Federal Motor Vehicle Safety Standard 208.

Even if your vehicle is equipped with air bags, **the safety belts must be worn at all times**, because the front air bag system is only actuated by frontal collisions with an impact of sufficient severity.

Below the deployment threshold of the air bag system, and during types of collisions which do not cause the actuation of the system, the safety belts provide the primary protection to the occupants when correctly worn. **Therefore, all persons within the vehicle must wear safety belts at all times** (in many states, state law requires the use of safety belts) to minimize the risk of severe injury or death in the event of a crash.

- ▷ Please see the chapter "SAFETY BELTS" on page 44.

The **front air bags** are located under the padded steering wheel panel on the driver's side, in the dashboard on the passenger's side, and in the knee area for both the driver and the passenger. The **side air bags** for the front and rear seats are installed on the side in or near the seat backrests. The **head air bags** are installed above the doors in the roof area.

Note

To minimize the risk of severe injury or death in the event of a crash, all occupants, including the driver, should always wear their seat belts whether or not an air bag is also provided at their seating position.

Danger!

To provide optimal occupant protection, air bags must inflate at very high speed. If you are not wearing your safety belt or are too close to the air bag when it is deployed, inflating air bags can result in serious personal injury or death.

- ▷ Make sure there are no people, animals or objects between the driver or passenger and the area into which the air bags inflate.
- ▷ Sit back as far from the dashboard or steering wheel as is practical, while still maintaining full vehicle control.
- ▷ Always hold the steering wheel by the outer rim. Never rest your hands on the air bag panel.
- ▷ **Always fasten seat belts** because triggering of the air bag system depends on the force and angle of impact.
- ▷ Do not transport heavy objects on or in front of the passenger seat. These could impair the function of the air bags, the seat belts, and occupant sensing.
- ▷ Do not hang objects (e. g., jackets, coats, coat hangers) over the backrest.

- ▷ Always keep the lid of the door storage compartment closed. Objects must not protrude out of the door storage compartment.
- ▷ Do not add any additional coverings or stickers to the steering wheel or in the area of the passenger air bag, side air bags, knee air bags, and head air bags. Doing so may adversely affect the functioning of the air bag system or cause harm to the occupants if the air bag system should deploy.
- ▷ No objects should be placed over or near the air bag on the instrument panel, because any such objects could cause harm if the vehicle is in a crash severe enough to cause the air bag to inflate.
- ▷ Do not modify the seat coverings, since such changes can block the seat-mounted side air bag. Do not attach additional cushions, protective coverings, or pillows to the passenger's seat. Do not affix things to the passenger's seat or cover it with other materials. Do not cover the back of the backrest. Do not make changes to the passenger's seat, the cushion or foam, the occupant sensor, and to the seat base frame.
- ▷ No changes must be made to the wiring or components of the air bag system.
- ▷ Do not install any wiring for electrical accessory equipment in the vicinity of the air bag wiring harnesses. Doing so may disable

the air bag system or cause inadvertent inflation.

- ▷ If the warning light comes on, the air bag system should be repaired immediately by your authorized Porsche dealer.
- ▷ Always keep feet in the footwell while driving. Do not put feet on the dashboard or the seat area. Do not lean against the inside of the door or outside the window while the vehicle is moving.
- ▷ Using accessories not approved by Porsche can cause the occupant sensing to be impaired.
- ▷ Do not squeeze objects, such as the fire extinguisher, or first aid kit under the seat.
- ▷ Only have seats removed and installed by an authorized Porsche dealer so that occupant sensing components will not be damaged.
- ▷ Give your passenger all of the information in this chapter.

Note

Air bag components (e.g. steering wheel, seats) may be disassembled only by an authorized Porsche dealer.

- ▷ When disposing of a used air bag unit, our safety instructions must be followed. These instructions can be obtained at any authorized Porsche dealer.

Function of the air bag system

Air bags are a supplemental safety system. Your primary protection comes from your safety belts.

The front air bags are triggered during a frontal collision of sufficient force and direction. In the event of a side impact of corresponding force, the side air bag on the impact side is triggered.

The inflation process generates the amount of gas required to fill the air bags at the necessary pressure in fractions of a second.

Air bags help to protect the head and body, while simultaneously damping the motion of the driver and passenger in the impact direction in the event of a frontal impact or side impact.

In order to help provide protection in severe collisions which can cause death and serious injury, air bags must inflate extremely rapidly. Such high speed inflation has a negative but unavoidable side effect, which is that it can and does cause injuries, including facial and arm abrasions, bruising and broken bones. You can help minimize such injuries by always wearing your safety belts.

There are many types of accidents in which air bags are not expected to deploy. These include accidents where the air bags would provide no benefit, such as a rear impact against your vehicle. Other accidents where the air bags are designed not to deploy are those where the risk of injury from the air bag deployment could exceed

any protective benefits, such as in low speed accidents or higher speed accidents where the vehicle decelerates over a longer time. Since air bag deployment does not occur in all accidents, this further emphasizes the need for you and your passengers to always wear safety belts.

Your vehicle is equipped with a crash sensing and diagnostic module. This module will record the use of the seat belt restraint system by the driver and front passenger when the air bags and/or belt tensioner are triggered.

Precondition for activating the restraint systems:

- ▷ Ignition is switched on.

Advanced air bag

Your vehicle is equipped with occupant sensing for the passenger's seat in accordance with U.S. Federal Motor Vehicle Safety Standard 208. Depending on the weight, body positioning and shape acting on the passenger's seat, the passenger's air bag will automatically be switched on and off.

Depending on the angle and force of impact, the passenger's air bag which is switched-on will be triggered during a collision.

Precondition for switching the passenger's air bag on and off, depending on weight, body positioning and shape:

- ▷ Ignition is switched on.

Danger!

Risk of serious personal injury or death due to the passenger air bag not triggering. Improper handling of occupant sensing can unintentionally impair switching the passenger's air bag off and on.

If the weight on the passenger's seat is reduced significantly, e.g., by supporting weight on the armrest, the passenger's air bag can be switched off.

- ▷ Select an upright seat position, and do not support weight on the armrests or lean out of the window. Always keep feet in the footwell while driving. Do not put feet on the dashboard or the seat area. Do not lean against the inside of the door or outside the window while the vehicle is moving.
- ▷ If a child restraint system is installed on the passenger's seat, do not adjust the seat.

Seat adjustment for the passenger's seat

Danger!

Safety belts only offer protection when the backrest is positioned at a comfortable upright seating angle and the belts are properly positioned on the body. Improperly positioned safety belts can cause serious personal injury or death in an accident.

- ▷ Do not operate the car with the driver or passenger backrests excessively reclined.

Vehicle modifications to accommodate persons with disabilities

Because modifications to your vehicle could compromise your advanced air bag system, please call 1-800-PORSCHE prior to having your vehicle modified.

Automatic deactivation of the passenger air bags

Before transporting a child on the passenger seat:

- ▷ Please see the chapter "CHILD RESTRAINT SYSTEMS" on page 52.
- When an **up to one-year old child** is seated in the child restraint system, the front air bag is automatically deactivated on the passenger side.
- When an adult is seated in the passenger's seat the front air bag is automatically activated.

Danger!

The use of a child restraint system in the front passenger seat can result in serious personal injury or death to the child from an air bag deployment.

To reduce risk of injury from an inflating air bag in an accident, Porsche strongly recommends:

- ▷ Under all normal circumstances, the child seat must be placed in the rear.
Do not use a child restraint system in the front passenger seat.



PASSENGER AIR BAG OFF indicator lamp

Note on operation

Depending on the weight acting on the passenger's seat, it can occur in the case of heavier children that the passenger air bags are active or, in the case of very light adults or young persons, that the passenger air bags are deactivated.

The condition of the passenger air bag system is shown by the indicator lamp in the overhead operating console.

- ▷ If in doubt, fasten the child restraint system on one of the rear seats or transport the passenger on a rear seat.

Note

- ▷ After switching on the ignition, the PASSENGER AIR BAG OFF warning light lights up for a few seconds as a check.

PASSENGER AIR BAG OFF indicator lamp lights up

The passenger's air bags are switched off.

PASSENGER AIR BAG OFF indicator lamp does not light up

The passenger's air bags are active and ready for operation.

Danger!

Risk of serious personal injury or death due to the passenger air bag triggering unintentionally.

When the ignition is on and the up to one-year old child is seated in the child restraint system on the passenger seat the indicator lamp "PASSENGER AIR BAG OFF" must be on.

If the "PASSENGER AIR BAG OFF" indicator lamp does not light up, it could indicate a fault in the system, and the air bag could inflate in a collision, placing the child at risk of death or severe injury from the inflating air bag.

In this case:

- ▷ Fasten the child restraint system on one of the rear seats immediately.
- ▷ Have the fault remedied at your nearest authorized Porsche dealer.

Warning light

Faults are indicated by a warning light in the instrument panel.

The air bag warning light illuminates when the electronic monitoring of the air bag system detects a malfunction of the sensors, safety belt system, occupant detection system, PASSENGER AIR BAG OFF indicator lamp, related wiring, air bag modules and control units.

- ▷ **In the following cases you should immediately consult an authorized Porsche dealer in order to assure the air bag system is functioning properly:**
 - If the warning light does not light up when the ignition is switched on **or**
 - If the warning light does not go out once the engine is running **or**
 - If the warning light appears while driving.

FarmaSOS.com

Important information

If you sell your Porsche, notify the purchaser that the vehicle is equipped with air bags, and refer them to the chapter „Air bag systems“ in the owner’s manual (safety and disposal rules).

Further information on the air bag system can be found on stickers attached to the sun visors, as well as on all air bag components.

For special recommendations on the use of child restraints:

- ▷ Please see the chapter “CHILD RESTRAINT SYSTEMS” on page 52.

Child Restraint Systems

Porsche recommends that all infants and children be restrained in child restraint systems at all times while the vehicle is in motion in accordance with applicable laws.

When possible, use only child restraint systems recommended by Porsche. These systems have been tested and adjusted to the interior of your Porsche and the appropriate child age groups. These child restraint systems are also designed to be secured in vehicle seats by the lap belt portion of the lap-shoulder-belt.

Other systems have not been tested and could entail an increased risk of injury.

The use of infant or child restraints is required by law in all 50 US states and the Canadian provinces. The child restraint system should be one that complies with U.S. Federal/Canadian Motor Vehicle Safety Standards and should be secured by a lap belt portion of a lap-shoulder belt or for child seats equipped with the LATCH system (**L**ower **A**nchorage and **T**ether for **C**hildren, also known as ISOFIX) to the LATCH anchorages.

You can obtain child seats that are LATCH compatible at your authorized Porsche dealer.

- ▷ Always observe the separate installation instructions for your child seat.

A statement by the seat manufacturer of compliance with this federal standard can be found on the instruction label on the restraint and in the instruction manual provided with the restraint.

تلفن شبانه روزی: ۰۲۱-۸۸۸۶۲۰۸۵

FarmaSOS.com

Danger!

Risk of serious personal injury or death to the child.

- ▷ Follow all child restraint instructions and warnings in this manual.

- When using an infant or child restraint system, be sure to follow all manufacturer's instructions on installation and use.
- Infants and small children should neither be held on the lap, nor should they share a safety belt with another occupant while the vehicle is in motion.
- Children too big for child restraint systems must use regular safety belts. A shoulder belt can be used providing it does not cross the face or the neck of the child.
- Choose a child restraint system according to the age and size of the child.
- Child restraint systems that are damaged or have been heavily stressed in an accident must be replaced immediately.
- Children could be endangered in a crash if their child restraints are not properly secured in vehicle.
- Do not affix objects to child restraint systems or cover them with other materials.
- ▷ For maximum safety and protection, do not use a child restraint system in the front passenger seat.

Direction of installation for child restraint systems

According to accident statistics, children are safer when properly restrained in the rear seating positions than in the front seating positions.

Under all normal circumstances, the child seat must be placed in the rear.

- ▷ Do not use a child restraint system in the front passenger seat.

Group 0 and 0+: Children up to 29 lbs (13 kg)

Children of this weight must be transported in a restraint system which is fitted **facing backwards**.

Group I: Children in between 20 lbs (9 kg) and 40 lbs (18 kg)

Children of this weight are transported in child restraint systems **facing forward**.

Group II: Children in between 33 lbs (15 kg) and 55 lbs (25 kg)

Children of this weight are transported in child restraint systems **facing forward**.

Group III: Children in between 49 lbs (22 kg) and 80 lbs (36 kg)

Children of this weight are transported in child restraint systems **facing forward**.

Using child restraint systems in the front passenger seat

Danger!

The use of a child restraint system in the front passenger seat can result in serious personal injury or death to the child from an air bag deployment.

To reduce risk of injury from an inflating air bag in an accident, Porsche strongly recommends:

- ▷ Under all normal circumstances, the child seat must be placed in the rear.
Do not use a child restraint system in the front passenger seat.

However, there may be serious situations where it might be necessary to place a child in the front seat so that he/she can be kept under direct observation to prevent an immediate risk to the child (for example, while driving to the doctor or hospital). The following instructions are provided to you solely for that purpose.

- ▷ Seek appropriate advice from your authorized Porsche dealer about the possible installation of a Porsche child restraint system.
- ▷ If a child restraint system must be fastened to the passenger's seat, adjust the passenger's seat as far away from the air bag as possible.

- ▷ If emergency or other serious conditions require a child to be placed in the front seat, exercise extreme caution and defensive driving of your vehicle.

Child restraint system for up to one-year old children

If the child restraint system must be fastened to the passenger's seat in exceptional cases:

- When an **up to one-year old child** is seated in the child restraint system, the front air bag is automatically deactivated on the passenger side.
- ▷ Make sure that the "PASSENGER AIR BAG OFF" indicator lamp lights up.
- ▷ Adjust the passenger's seat as far away from the air bag as possible.

! Danger!

Risk of serious personal injury or death due to the passenger air bag triggering unintentionally.

When the ignition is on and the up to one-year old child is seated in the child restraint system on the passenger seat the indicator lamp "PASSENGER AIR BAG OFF" must be on.

If the "PASSENGER AIR BAG OFF" indicator lamp does not light up, it could indicate a fault in the system.

In this case:

- ▷ Fasten the child restraint system on one of the rear seats immediately.
- ▷ Have the fault remedied at your nearest authorized Porsche dealer.

Child restraint system for children older than one year

Your vehicle is equipped with occupant sensing for the passenger's seat in accordance with U.S. Federal Motor Vehicle Safety Standard 208. Depending on the weight acting on the passenger's seat, the passenger's air bag will automatically be switched on or off.

- ▷ In case of doubt, fasten the child restraint system on one of the rear seats.

Small adult passengers

- ▷ Make sure that the PASSENGER AIR BAG OFF indicator lamp does not light up.

! Danger!

Risk of serious or mortal injury due to the passenger air bag not triggering.

When the ignition is on and the small adult passenger is seated on the passenger seat, the indicator lamp "PASSENGER AIR BAG OFF" must be off.

If the "PASSENGER AIR BAG OFF" indicator lamp lights up, it could indicate a fault in the system.

In this case:

- ▷ Fasten the child restraint system on one of the rear seats immediately.
- ▷ Have the fault remedied at your nearest authorized Porsche dealer.

Automatic locking retractor

The safety belts for the front passenger and the rear seats are equipped with an automatic locking retractor for securing the child restraint system. When activated, this retractor allows you to securely fasten the child restraint system in place so that inadvertent movements will not occur.

Danger!

The use of a child restraint system on the front passenger seat can result in serious personal injury or death to the child from an air bag deployment.

To reduce risk of injury from an inflating air bag in an accident, Porsche strongly recommends:

- ▷ Under all normal circumstances, the child seat must be placed in the rear.
Do not use a child restraint system on the front passenger seat.

If there are emergency reasons for transporting a child in the front passenger seat, use the automatic locking retractor function and follow the other safety instructions on the previous pages in this section.



PASSENGER AIR BAG OFF indicator lamp

تلفن شبانه روزی: ۰۲۱-۸۸۸۶۲۰۸۵

FarmaSOS.com

Danger!

Risk of serious personal injury or death to the child, when excessive force is acting on the passenger's seat due to the seat belt and the passenger's air bag is switched on unintentionally.

- ▷ **After fastening the child restraint system, do not adjust the seat in any direction.**

Moving the seat could adjust the safety belt against the child restraint and cause the "PASSENGER AIR BAG OFF" indicator lamp to go off and activate the air bag system.

- ▶ **Check the condition of the passenger air bag system shown by the indicator lamp in the overhead operating console.**

Activating the automatic locking retractor

1. If a child restraint system must be fastened to the passenger's seat, adjust the passenger's seat as far away from the air bag as possible.
2. Position child seat according to the child seat's manufacturer instructions.
3. Pull the safety belt retractor completely out. At this point the locking mechanism is activated.
4. Insert the safety belt tongue into the buckle and make certain that it is properly latched. Make no more adjustments to the seat.
5. Allow the safety belt to retract until it is tight on the child restraint system. You may further tighten the belt by pulling on it to allow more of it to retract.
Make sure that excessive seat belt forces do not occur by moving the seat with the child seat installed.

Releasing the safety belt

- ▷ Unbuckle the safety belt latch.

Then make certain that the belt has fully retracted. At this point the automatic locking feature will be disengaged.

Seek appropriate advice from your authorized Porsche dealer about the possible installation of a Porsche child restraint system.

LATCH Child Seat System

LATCH child seats are the best option for mounting a child seat in your Porsche. Such LATCH child seats can be installed only using the LATCH system in the rear seats.

Use only child restraint systems with the LATCH system (**L**ower **A**nchorage and **T**ether for **C**hildren) recommended by Porsche.

These systems have been tested and adjusted to the interior of your Porsche and the appropriate child age groups. Other systems have not been tested and could entail an increased risk of injury.

You can obtain child seats that are LATCH-compatible at your authorized Porsche dealer.

Always observe the separate installation instructions for your child seat.

تلفن شبانه روزی: ۰۲۱-۸۸۶۲۰۸۵

FarmaSOS.com



Using a LATCH child seat system

Both of the rear seats are equipped with the LATCH system (lower anchorage and anchor points for tether straps on the back of the backrests).

Markings on the right and left for the LATCH child seat anchorage can be found on the seat cushions of the rear seats.

The anchor bars **A** for the LATCH child seat anchorage can be found directly under the markings between backrest and seat cushion.

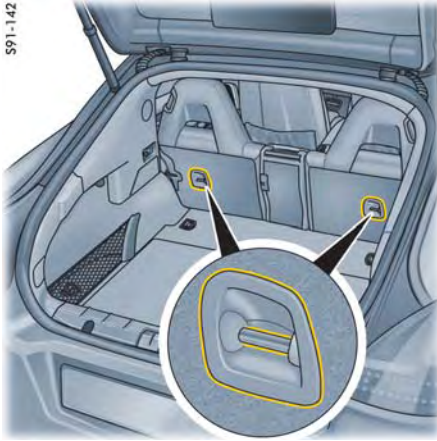

Child Restraint Anchorages

- ▶ Please see the chapter “AUTOMATIC LOCKING RETRACTOR” on page 55.

If your child restraint seat or seats require the use of a tether strap, you will want to use the anchor points provided behind each rear seat's backrest. To ensure proper installation, see your authorized Porsche dealer.

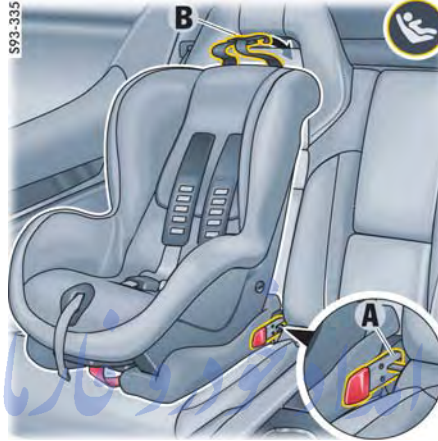

Installing a LATCH child seat system

- ▶ Always observe the separate installation instructions for your child seat.
1. Secure the child seat to retaining lugs **A** as outlined in the operating manual for the child seat.
 2. Pull the child seat to check that both fastening points are engaged correctly.
 3. If the child restraint seat or seats require the use of a tether strap, feed the tether strap **B** through the head restraint.



4. Attach the tether strap to the anchor point behind the backrest and pull it tight.

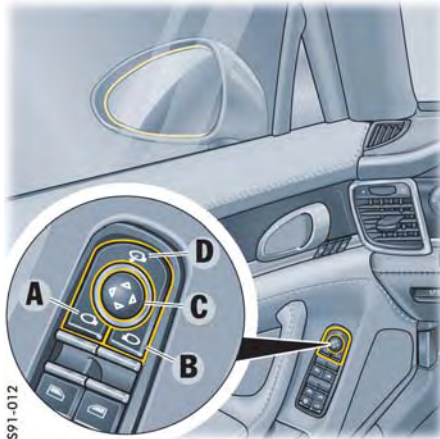

S91-012

- A - Exterior mirror selection – driver's side
- B - Exterior mirror selection – passenger's side
- C - Adjusting exterior mirrors
- D - Folding in exterior mirrors

Exterior Mirrors

The convex mirror on the passenger's side and the aspherical mirror on the driver's side provide a larger field of view.

Warning!

Risk of accidents. Vehicles or objects appear smaller in convex mirrors and further away than they are in reality.

- ▷ Bear this distortion in mind when estimating the distance of vehicles behind you and when reversing into a parking space.
- ▷ Also make use of the interior mirror for judging distance.

Risk of damage to the exterior mirrors when washing the vehicle in a car wash.

- ▷ Fold in exterior mirrors before using the car wash.

Adjusting exterior mirrors

The electrical exterior mirror adjuster is ready for operation:

- With ignition switched on.
- After the ignition is switched off and before the driver's or passenger's door is first opened, but for a maximum of 10 minutes.



S91-013

1. Press selection button **A** for the driver's side and selection button **B** for the passenger's side. The indicator light on the pressed button lights up.
2. Move the exterior mirrors to the correct position by pressing the adjustment button **C**.

If the electrical adjustment facility fails

- ▷ Adjust the mirror by pressing on the mirror face.

Folding in exterior mirrors

- ▷ Press button **D**.
Both exterior mirrors fold in automatically.

If the electrical adjustment facility fails

- ▷ Fold in mirrors manually.

Folding out exterior mirrors

- ▷ Press button **D**.
Both exterior mirrors unfold automatically.

Folding exterior mirrors in and out automatically

The exterior-mirrors can be folded in automatically after the vehicle is locked.

Folding exterior mirrors in automatically

- ▷ Press and hold the button  on the car key for at least 1 second.
or
On vehicles with Porsche Entry & Drive, press and hold the locking button in the handle on the driver's door for at least 1 second.
The exterior mirrors fold in.

Folding exterior mirrors out automatically

- ▷ Switch on ignition.
The exterior mirrors fold out.

Note – ۸۵۰۶۲۰۸۵ – تلفن شبانه روزی:
The exterior mirrors do not fold out automatically after the ignition is switched on if they were folded in manually using the button **D**.

If the electrical adjustment facility fails

- ▷ Unfold mirrors manually.

Storing exterior mirror settings

On vehicles with driver or comfort memory, individual exterior mirror settings can be stored on the person buttons on the driver's side and on the car key.

For further information on retrieving and storing vehicle settings:

- ▷ Please see the chapter "STORING VEHICLE SETTINGS" on page 40.

Exterior mirror heating

The exterior mirror heating is activated automatically when the heated rear window is switched on while the engine is running.

For information on switching on the heated rear window:

- ▷ Please see the chapter "HEATED REAR WINDOW/EXTERIOR MIRROR HEATING" on page 84.

Automatic anti-dazzle exterior mirror

The exterior mirrors change to anti-dazzle position automatically in synchronisation with the interior mirror.

For information on the automatic anti-dazzle function of the interior mirror:

- ▷ Please see the chapter “AUTOMATIC ANTI-DAZZLE INTERIOR MIRROR” on page 60.

Swivelling down mirror glass as parking aid

When reverse gear is engaged, the mirror on the **passenger's side** swivels down slightly to show the curb area.

- ▷ Please see the chapter “SWIVELLING DOWN MIRROR GLASS AS PARKING AID” on page 242.

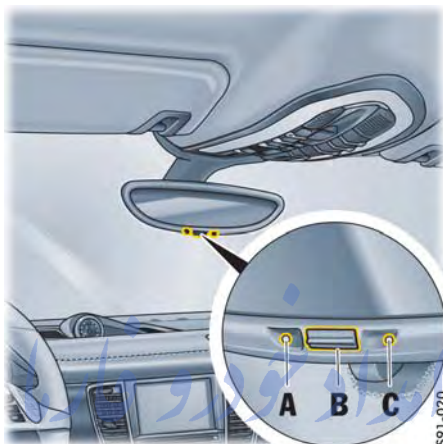

Automatic anti-dazzle interior mirror

Sensors on the front and rear sides of the interior mirror measure the incident light. The mirrors automatically change to anti-dazzle position or revert to their normal state, depending on the light intensity.

Note on operation

The incidental light within the detection area of the light sensor **C** must not be restricted (e.g. by stickers on the rear window or items of luggage in the luggage compartment).

Switching off automatic anti-dazzle function

- ▷ Press button **B**.
The indicator light **A** goes out.

Note on operation

The anti-dazzle function switches off automatically if:

- Reverse gear is engaged **or**
- Interior lighting is switched on.

Switching on automatic anti-dazzle function

- ▷ Press button **B**.
Indicator light **A** lights up.

Warning!

Risk of injury. Electrolyte fluid may escape from broken mirror glass. This fluid irritates the skin and eyes.

- ▷ If the electrolyte fluid should come into contact with the skin or eyes, rinse it off immediately with clean water.
Seek medical attention if necessary.

Risk of damage to paintwork, leather, plastic parts and clothing. Electrolyte fluid can be removed only while it is still wet.

- ▷ Clean the affected parts with water.

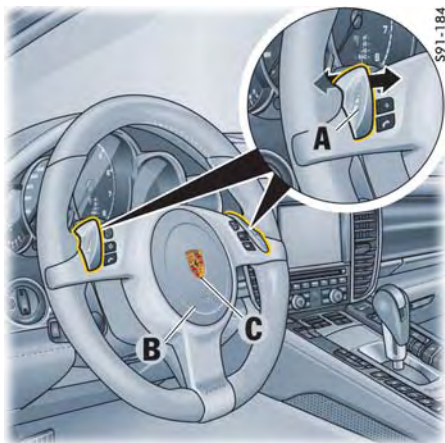

S91-184

For more information on shifting with the Porsche Doppelkupplung (PDK):

- ▷ Please see the chapter “PORSCHÉ DOPPELKUPPLUNG (PDK)” on page 193.

Horn

- ▷ Press button **B** to operate the horn.

Air bag unit

The air bag unit **C** is located behind the padded steering wheel boss.

In conjunction with the seat belts, the air bag is a safety system designed to provide the driver with maximum protection from injury in an accident.

For information on the air bag system:

- ▷ Please see the chapter “AIR BAG SYSTEMS” on page 47.

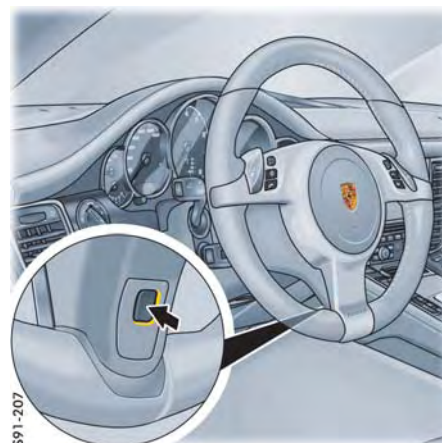

S91-207

Heated steering wheel

The steering wheel heating can be switched on and off with the button on the rear of the steering wheel when the ignition is switched on.

Switching steering wheel heating on/off

- ▷ Press button.
The message “Steering wheel heating switched on” or “Steering wheel heating switched off” appears on the multi-function display for 2 seconds.

Steering Wheel

PDK shift buttons

Porsche Doppelkupplung (PDK) is a seven-speed transmission with an “automatic” and a “manual” selection mode.

You can change temporarily to manual mode or shift gear in manual mode with the shift buttons **A** on the steering wheel.

FarmaSOS.com

Steering Wheel Adjustment

The steering wheel can be adjusted manually or electrically in four directions depending on the vehicle equipment.

Warning!

Risk of accidents. The steering wheel may move further than desired if you attempt to adjust it when driving.

You may lose control of the vehicle.

- ▷ Do not adjust the steering wheel when driving.

Risk of crushing due to uncontrolled activation of memory settings.

- ▷ Do not leave children in the vehicle unattended.

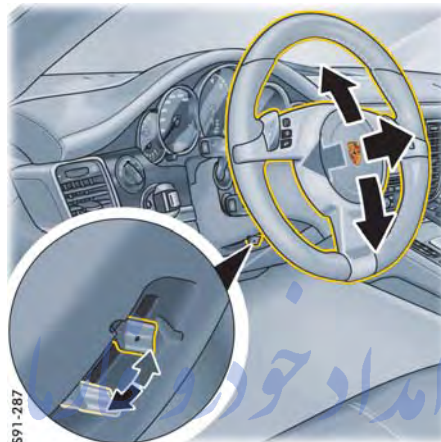

Manual steering wheel adjustment

Adjusting steering wheel manually

1. Insert the ignition key into the ignition lock.
2. Push locking lever downwards.
3. Adjust steering wheel to suit the chosen backrest angle and your seat position by moving the steering wheel up or down and longitudinally.
4. Swivel locking lever back until you feel it engage.
If necessary, move the steering wheel slightly in a longitudinal direction.

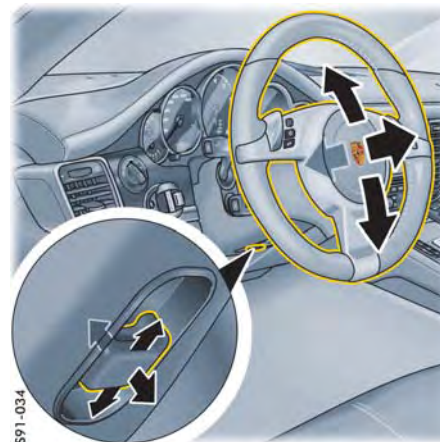

Electric steering wheel adjustment

Adjusting steering wheel electrically

- ▷ Press control switch B under the steering column in the relevant direction until the desired setting is reached.

The steering wheel setting is stored in the vehicle settings.

For further information on storing and retrieving the steering wheel setting:

- ▷ Please see the chapter "STORING VEHICLE SETTINGS" on page 40.

Multi-Function Steering Wheel



Warning!

There is a risk of accident if you set or operate the multi-function display, radio, navigation system, telephone or other equipment while driving. Operating these devices while driving could distract you from traffic and cause you to lose control of the vehicle.

- ▷ Operate the equipment while driving only if the traffic situation allows you to do so safely.
- ▷ Carry out any complicated operating or setting procedures only when the vehicle is stationary.

Depending on the equipment in your vehicle, you can use the function keys of the multi-function steering wheel to operate the following Porsche communication systems:

- Telephone
- PCM
- Multi-function display in the instrument panel



Readiness for operation of the multi-function steering wheel

- With ignition switched on
- ▷ Please observe the operating instructions supplied for the Porsche communication systems before operating the function keys.

Note on operation

The Porsche communication systems cannot be switched on and off using the multi-function steering wheel.

Function buttons on the multi-function steering wheel

The rotary buttons at the top left and right of the steering wheel can also be pressed.



Turn volume control

Upwards – increase volume
Downwards – decrease volume

Press volume control

Switch volume/mute on and off.



Turn rotary knob

Select/highlight the main menu or menu item on the multi-function display by turning the rotary knob upward or downward.

Press rotary knob

Go to submenu or activate selected function.



Press MFS button

Call up the stored function. The button can be assigned the desired function in the multi-function display on the instrument panel.



Press Back button

Return to the menu.



Press Handset Pickup button

Accept a telephone call.



Press Handset Hangup button

End or refuse a telephone call.

S91-018

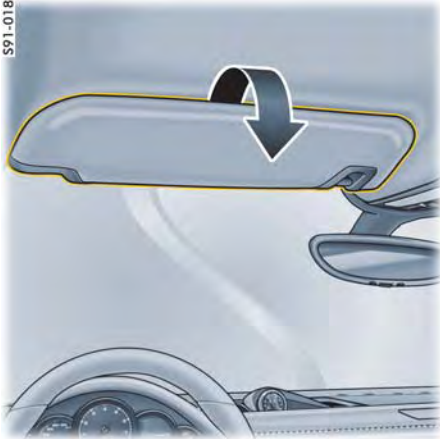

Sun Visors

- ▷ Swivel the sun visor down to prevent dazzle from the front.
- ▷ If you are dazzled from the side, unclip the sun visor from the inner bracket and swivel it round so that it is in front of the door window.

S91-064



Vanity Mirror

The vanity mirror on the rear of the sun visor is closed with a sliding cover.



Caution!

Risk of injury.

- ▷ Keep the sliding cover closed while driving.

The vanity mirror lighting is switched on automatically when the sliding cover is opened (**arrow**).

Roll-Up Sunblinds, Rear Side Windows

Note on operation

The roll-up sunblinds on the rear side windows can be raised or lowered only when the rear side windows are closed.

If child protection is activated, the roll-up sunblinds on the rear side windows can only be operated using the roll-up sunblind button in the front center console or the power window buttons in the driver's door.

For information on child protection:

- ▷ Please see the chapter "DISABLING THE CONTROLS IN THE REAR" on page 88.

For information on the roll-up sunblind button:

- ▷ Please see the chapter "RAISING/LOWERING ROLL-UP SUNBLIND ON REAR WINDOW" on page 66.



Raising roll-up sunblind on rear side windows

- ▷ Pull up the corresponding power window button on the inside of the rear door or the driver's door.
or
If the rear roll-up blind is lowered, press and hold the roll-up sunblind button on the front or rear center console for approximately 1 second.
The indicator light on the button lights up.
The roll-up sunblinds on the rear window and the rear side windows are raised.



Lowering roll-up sunblind on rear side windows

- ▷ Push down the corresponding power window button on the inside of the rear door or the driver's door.
or
If the rear roll-up blind is raised, press and hold the roll-up sunblind button on the front or rear center console for approximately 1 second.
The indicator light on the button lights up.
The roll-up sunblinds on the rear window and the rear side windows are lowered.



Front roll-up sunblind button

Roll-Up Sunblind, Rear Window

Raising/lowering roll-up sunblind on rear window

When the ignition is switched on, the roll-up sunblind in the luggage compartment cover can be raised and lowered.

- ▷ Press the front or rear roll-up sunblind button. The indicator light on the button lights up. The roll-up sunblind is raised or lowered

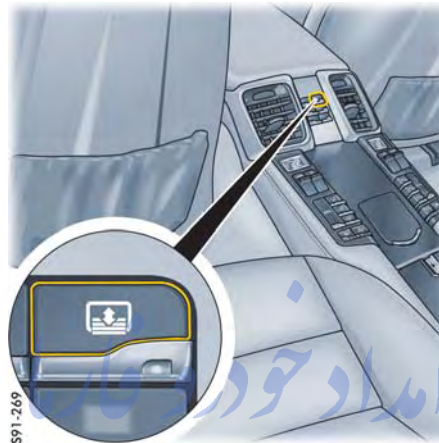

Rear roll-up sunblind button

Note on operation

If child protection is activated, the rear window roll-up sunblind can only be operated using the roll-up blind button in the front center console.

For information on child protection:

- ▷ Please see the chapter “DISABLING THE CONTROLS IN THE REAR” on page 88.

Automatic lowering of the rear window roll-up sunblind when reverse gear is engaged

If the roll-up sunblind is raised when reverse gear is engaged, the roll-up blind is lowered automatically.

The roll-up sunblind is raised when the vehicle drives forward again.

Preconditions

- The ignition must be switched on.
- The function must be activated on the multi-function display.

For information on setting the automatic lowering function:

- ▷ Please see the chapter “ADJUSTING REVERSING OPTIONS” on page 144.

Air Conditioning

Brief Overview – Front Control Panel	68
Brief Overview – Rear Control Panel	
(4-Zone Air-Conditioning)	69
Overview of Air Conditioning.....	70
General Functions	71
Automatically Controlled Air Conditioning.....	76
Air Vents.....	82
Heated Rear Window/Exterior Mirror	
Heating	84

امداد خودرو فارما

تلفن شبانه روزی: ۰۲۱-۸۸۸۶۲۰۸۵

FarmaSOS.com

Brief Overview – Front Control Panel

This brief overview does not replace the information provided under “AUTOMATICALLY CONTROLLED AIR-CONDITIONING SYSTEM”.

Warnings, in particular, are not replaced by this brief overview.

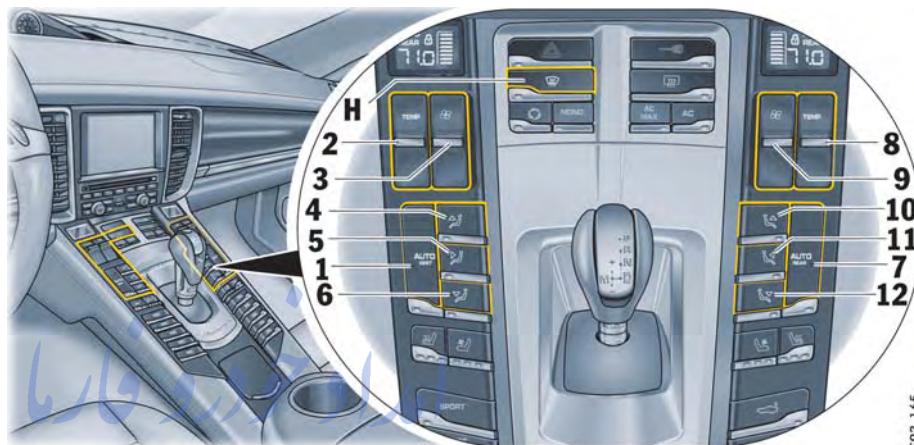

What do I want to do?	What do I have to do?
Switch on climate control	Press the button 1 for the left side or the button 7 for the right side.
Set temperature	Left vehicle side: Press button 2 up (warmer) or down (colder). Right vehicle side: Press button 8 up (warmer) or down (colder).
Set air quantity manually	Left vehicle side: Press button 3 up (more) or down (less). Right vehicle side: Press button 9 up (more) or down (less).
Set air distribution manually	Air to windshield for left or right side: Press button 4 or 10 . Air to central and side vents for left or right side: Press button 5 or 11 . Air to footwell for left or right side: Press button 6 or 12 .
Defrost windshield	Press button H .

Brief Overview – Rear Control Panel (4-Zone Air-Conditioning)

This brief overview does not replace the information provided under “AUTOMATICALLY CONTROLLED AIR-CONDITIONING SYSTEM”.

Warnings, in particular, are not replaced by this brief overview.

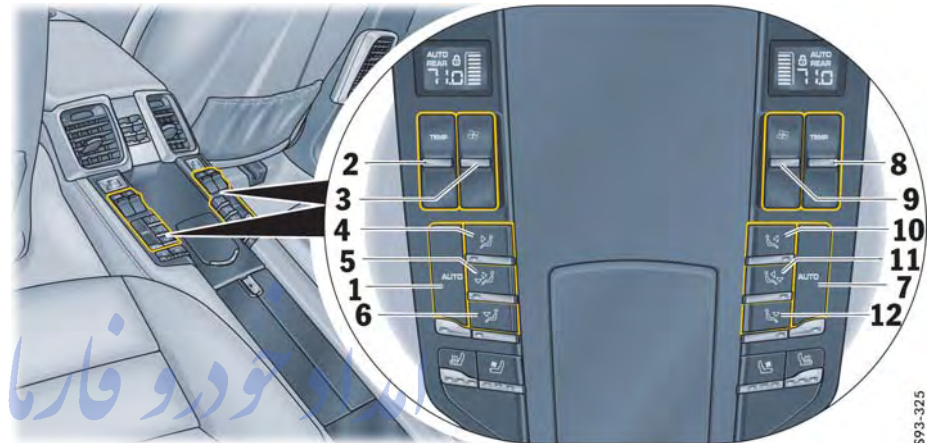

593-325

What do I want to do?

Switch on climate control

What do I have to do?

Press the button **1** for the left side or the button **7** for the right side.

Set temperature

For left side: Press button **2** up (warmer) or down (colder).
For right side: Press button **8** up (warmer) or down (colder).

Set air quantity manually

For left side: Press button **3** up (more) or down (less).
For right side: Press button **9** up (more) or down (less).

Set air distribution manually

Air to door vents and central vents for left or right side: Press button **4** or **10**.
Air to door vents, central vents and to footwell for left or right side: Press button **5** or **11**.
Air to door vents and footwell for left or right side: Press button **6** or **12**.



Front air-conditioning control panel



Rear air-conditioning control panel
(4-zone air-conditioning)



Interior temperature sensor

Overview of Air Conditioning

The following air-conditioning system types may be installed, depending on your vehicle equipment:

Automatically controlled 2-zone air conditioning

The air-conditioning system controls the preselected interior temperature completely automatically.

The temperature, air quantity and air distribution can be set individually for the **left** and **right** air-conditioned areas.

Automatically controlled 4-zone air conditioning

The air-conditioning system controls the preset interior temperature completely automatically. Temperature, air quantity and air distribution can be set individually for the **front left**, **front right**, **rear left** and **rear right** air-conditioned areas.

Vehicles with 4-zone air-conditioning have an additional control panel on the rear center console.

Sensors

To avoid impairing the performance of the air-conditioning system:

- ▷ Do not cover or tape over the interior temperature sensor for the air-conditioning system.

General Functions

Note on operation

Additional settings relating to the climate type and extended ventilation panel can be adjusted in the multi-function display on the instrument panel:

- ▷ Please see the chapter “AIR-CONDITIONING SETTINGS ON THE MULTI-FUNCTION DISPLAY” on page 83.
- ▷ Please see the chapter “SETTING AIR CONDITIONING” on page 146.

On vehicles with comfort memory, all air-conditioning settings are stored on the relevant ignition key when the vehicle is locked.

REST mode

Using engine residual heat

The residual heat of the engine can be used to heat the interior for up to 20 minutes after the ignition has been switched off.

- ▷ When the ignition is switched off:
Press button **AUTO** REST on the front control panel.
The indicator light on the button lights up.
The air-conditioning settings cannot be changed in REST mode.



Deactivating the function

- ▷ Press button **AUTO** REST on the front control panel.
The indicator light on the button goes out.
or
Switch on ignition.
The indicator light on the button indicates the previous setting.

Note on operation

If the battery voltage is too low, REST mode is restricted initially and then switched off.

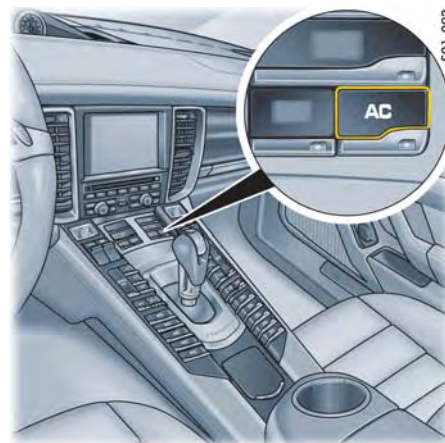

AC mode

In automatic mode, AC mode is always activated. The power of the compressor from the air-conditioning system is regulated fully automatically according to requirements. At outside temperatures below approx. 38 °F (3 °C), the air-conditioning compressor is switched off automatically.

For information on switching automatic mode on and off:

- ▷ Please see the chapter “SWITCHING AUTOMATIC MODE ON/OFF” on page 77.

Switching on AC mode

If you wish to cool the passenger compartment to a temperature lower than the outside temperature, AC mode must be activated.

- ▷ Press button **AC**.
The indicator light on the button lights up.
The air-conditioning compressor is switched on.
or
Press button **AUTO**.

Switching off AC mode

AC mode can be switched off manually to save fuel, for example.

- ▷ Press button **AC**.
The indicator light on the button goes out.
The air-conditioning compressor is switched off.
The cooling function is deactivated.



AC MAX mode

In AC MAX mode, the interior of the passenger compartment is cooled at maximum power. The interior temperature is not adjusted automatically.

Switching AC MAX mode on

- ▷ Press button **AC MAX**.
The indicator light on the button lights up.

Switching AC MAX mode off.

- ▷ Press button **AC MAX**.
The indicator light on the button goes out.
or
Press button **AUTO**.

Increased cooling output in AC MAX mode on 4-zone air-conditioning system

On the automatic 4-zone air-conditioning system, AC MAX mode provides additional cooling output for the front air-conditioned areas. The air-conditioned areas in the rear are deactivated automatically to achieve this increase in cooling output. OFF appears in the displays on the operating unit for the rear air-conditioned areas.



Note on 2-zone air conditioning

The windshield is defrosted with maximum efficiency when the air vents in the rear are closed.

For information on air vents:

- ▷ Please see the chapter "AIR VENTS" on page 82.

Note on 4-zone air conditioning

In defrosting mode, the air supply to the rear is cut off automatically to achieve maximum defrosting efficiency.

The air flows to the windshield and the front side windows.

OFF and a lock symbol appear in the displays on the operating unit for the rear air-conditioned areas. Air-conditioning settings cannot be modified.

امداد خودرو فارما

تلفن شبانه روزی: ۰۲۱-۸۸۸۶۲۰۸۵

FarmaSOS.com

Defrosting the windshield

Activating defrosting function

- ▷ Press button .
The indicator light on the button lights up.
The air flows to the windshield and the front side windows.
The windshield is demisted or defrosted as quickly as possible.

Deactivating defrosting function

- ▷ Press button .
The indicator light on the button goes out.
or
Press button **AUTO**.



S91-090

Switching off MONO mode

- ▷ Press button **MONO**.
The indicator light on the button goes out.
- or**
- The settings for one of the other air-conditioned areas change.

امداد خودرو فارما

تلفن شبانه روزی: ۰۲۱-۸۸۸۶۲۰۸۵

FarmaSOS.com

Accepting settings for driver's side for the entire vehicle

The MONO function allows the air-conditioning settings for the driver's side to be accepted for the entire vehicle.

Switching on MONO mode

- ▷ Press button **MONO**.
The indicator light on the button lights up.
The display indicator values for the other areas adopt the same values as the driver's settings.



S91-089

Air-recirculation mode

Switching on air-recirculation mode

- ▷ Press button .
The indicator light on the button lights up.
The outside-air supply is interrupted and only the inside air is recirculated.

Switching air-recirculation mode off

- ▷ Press button .
The indicator light on the button goes out.

Note

If the air-conditioning compressor is switched off manually or automatically, air-recirculation mode ends after approx. 3 minutes.

Setting automatic air-recirculation mode

In automatic air-recirculation mode, the fresh air supply is adjusted depending on the air quality.

Automatic air-recirculation mode can be switched on and off on the multi-function display.

At outside temperatures below approx. 50 °F (10 °C), air-recirculation mode is deactivated automatically to prevent the windows from misting.

For information on adjusting automatic air-recirculation mode on the multi-function display:

- ▷ Please see the chapter “SETTING AIR CONDITIONING” on page 146.

Note

The recommended operating mode is automatic air-recirculation mode (default setting).

Information on the air-conditioning compressor

The air-conditioning compressor:

- Can switch off briefly to ensure sufficient engine cooling if the engine is operating under extreme load.
- Automatically switches off at temperatures below 38 °F (3 °C) and cannot be switched on, even manually.

- Operates most effectively with the windows closed.

If the vehicle has been in the sun for a long time, it is a good idea to ventilate the interior briefly with the windows open.

- Depending on the outside temperature and humidity, condensation can drip from the evaporator and form a pool under the vehicle. This is normal and not a sign of leaks.

Information on automatic load switch-off

If the charging condition of the battery is critical, the following air-conditioning or heating functions are restricted initially and then switched off.

- Heated seats
- Heated rear window/External mirror heating
- Fresh-air blower
- Air-conditioning compressor

FarmaSOS.com

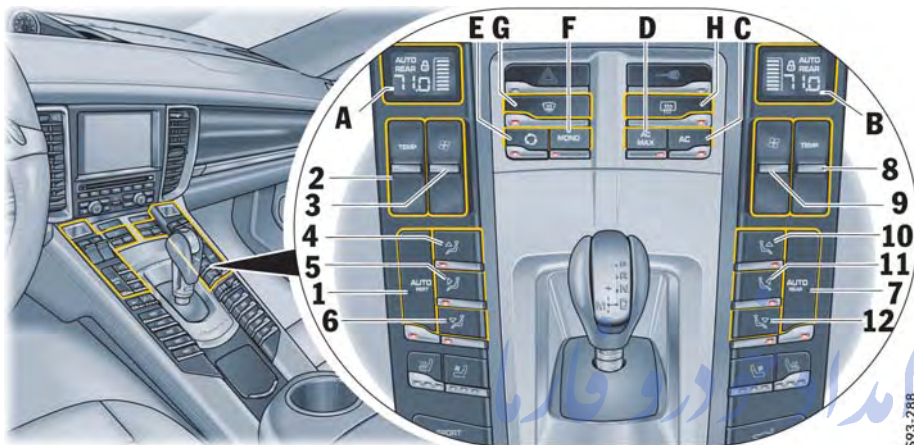

Front control panel
(2-zone and 4-zone air conditioning systems)

Automatically Controlled Air Conditioning

Depending on various factors (e.g. sunlight, air quality, ambient temperature, misted windows), the air-conditioning system adjusts the preset interior temperature, air distribution and air quantity fully automatically.

Automatic mode is deactivated as soon as the settings are adjusted manually. In this case, automatic climate control still regulates the air-conditioning functions that have not been modified manually.

Front control panel, left air-conditioned area

- A** - Air-conditioning display, left side
- 1** - AUTO mode, left side (automatic mode)/ REST mode (using engine residual heat)
- 2** - Temperature, left side
- 3** - Air quantity, left side
- 4** - Air to windshield, left side
- 5** - Air to center and side vents, left side
- 6** - Air to footwell, left side

Front control panel, right air-conditioned area

- B** - Air-conditioning display, right side
- 7** - AUTO mode, right side (automatic mode)/ REAR mode (adjusting rear air-conditioned areas using the front control panel) (4-zone air conditioning)
- 8** - Temperature, right side
- 9** - Air quantity, right side
- 10** - Air to windshield, right side
- 11** - Air to central and side vents, right side
- 12** - Air to footwell, right side

Front control panel, general functions

- C** - AC mode (air-conditioning compressor on/off)
- D** - AC MAX mode (maximum cooling output)
- E** - Air-recirculation mode
- F** - MONO mode (adopt driver's air-conditioning settings for all air-conditioned areas)
- G** - Defrosting the windshield
- H** - Heated rear window/door mirror heating

Please read the information on:

- **REST mode**, see page 71.
- **AC mode**, see page 71.
- **AC MAX mode**, see page 72.
- **MONO mode**, see page 74.
- **Defrosting the windshield**, see page 73.
- **Air-recirculation mode**, see page 74.
- **Air-conditioning compressor**, see page 75.

تلفن شبانه روزی: ۰۲۱-۸۸۶۲۰۸۵

FarmoSOS.com

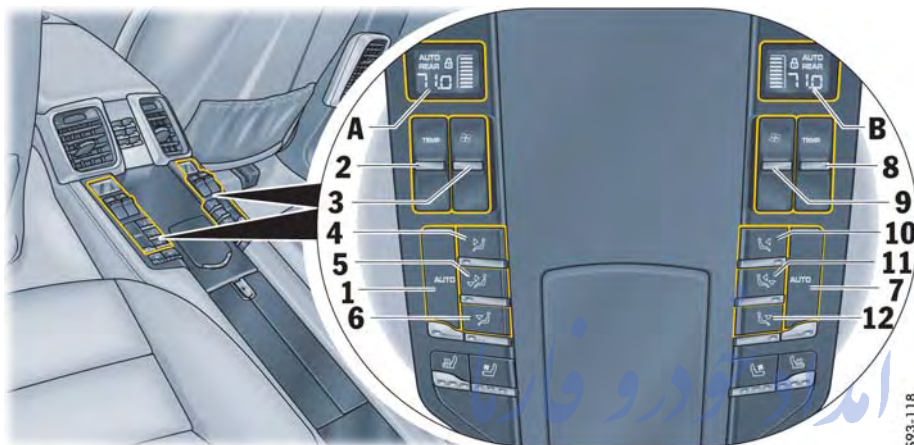

Rear control panel, left air-conditioned area

- A** - Air-conditioning display, left side
1 - AUTO mode, left side (automatic mode)
2 - Temperature, left side
3 - Air quantity, left side
4 - Air to door vents and central vents, left side
5 - Air to door vents, central vents and to footwell on left side
6 - Air to door vents and footwell on left side

Rear control panel, right air-conditioned area

- B** - Air-conditioning display, right side
7 - AUTO mode, right side (automatic mode)
8 - Temperature, right side
9 - Air quantity, right side
10 - Air to door vents and central vents, right side
11 - Air to door vents, central vents and to footwell on right side
12 - Air to footwell, right side

Rear control panel (4-zone air-conditioning)

Switching automatic mode on/off

The front and rear air-conditioned areas can be switched to automatic mode independently of one another.

- ▷ Press button **AUTO** for the relevant air-conditioned area on the front or rear control panel.
 The indicator light on the button and the AUTO indicator on the air-conditioning display light up.
 Temperature, air quantity and air distribution are adjusted automatically for the relevant air-conditioned area.

Note on operation

If necessary, the automatic system can be controlled manually.

The manual setting is retained until the appropriate function button is pressed again or the button **AUTO** is pressed.



Temperature and air quantity, front control panel

Setting temperature

For personal comfort, the interior temperature can be adjusted individually between 60 °F (16 °C) and 87 °F (29.5 °C).

Recommendation: 72 °F (22 °C)

The selected temperature is shown on the display above the button **TEMP**.

Increasing temperature

- ▷ Press button **TEMP** for the relevant air-conditioned area upwards.
The preset temperature value is shown on the air-conditioning display.

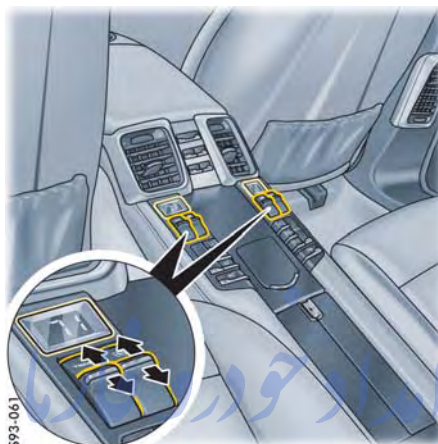

Temperature and air quantity on the rear control panel (4-zone air-conditioning)

Reducing temperature

- ▷ Press button **TEMP** for the relevant air-conditioned area downwards.
The preset temperature value is shown on the air-conditioning display.

If LO or HI appears on the display, the system is operating at maximum cooling or heating power. Automatic mode is switched off.

Note on operation

If one air-conditioned area is set to **LO** or **HI**, the other air-conditioned areas are also set to **LO** or **HI**.

Pressing the button **AUTO** selects the preset temperature.

Note

The air-conditioning system always cools and heats the passenger compartment to the preset temperature at maximum cooling or heating temperature.

Setting the temperature temporarily to a lower or higher value does **not** cool or heat the passenger compartment to the desired temperature more quickly.

Setting air quantity

The selected air quantity is shown in a bar display above the button . The more bars that are displayed, the more air flows into the passenger compartment.

Increasing air quantity

- ▷ Press button  for the air quantity to the relevant air-conditioned area upwards.

Reducing air quantity

- ▷ Press button  for the air quantity to the relevant air-conditioned area downwards.

Press button **AUTO** for the relevant air-conditioned area to switch back to automatic mode.

If the air quantity was reduced so much that OFF appears on the air-conditioning system display, the supply of air from the outside is interrupted.

Warning!

Risk of accidents due to impaired vision.
The windows can mist up if the air quantity setting is OFF.



- ▷ Only select air quantity setting OFF for short periods.
- ▷ If windows mist up, press  for the left and right vehicle side on the front control panel upwards (increase air quantity).



Air distribution, front control panel

Setting air distribution manually

Front control panel

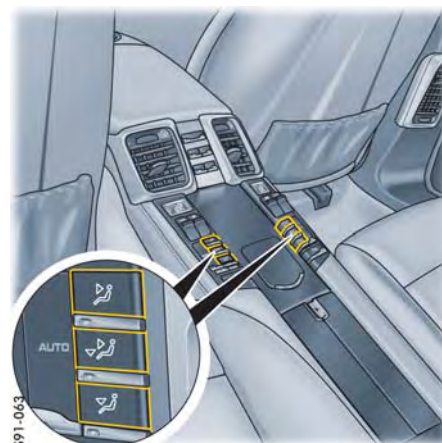

- ▷ Press button .
The air flows to the windshield and the side windows.
- ▷ Press button .
The air flows from the central and side vents.
The air vents must be open.
- ▷ Press button .
The air flows to the footwell.

The indicator light on the button lights up.



*Air distribution, rear control panel
(4-zone air conditioning)*

Rear control panel (4-zone air-conditioning)



- ▷ Press button .
The air flows from the central vents and the vents in the door pillars. The air vents must be open.
- ▷ Press button .
The air flows from the central vents, into the footwell and from the vent in the door pillar.
- ▷ Press button .
The air flows into the footwell and from the vent in the door pillar.

The indicator light on the button lights up.

Canceling manual air distribution

- ▷ Press the relevant air distribution button again. The indicator light on the button goes out.
or
Press button **AUTO** for the relevant air-conditioned area.
The indicator light on the button lights up.
Air quantity and distribution are controlled automatically and variations are compensated.

Air distribution in the rear air-conditioned areas when MONO or REAR mode is activated (4-zone air conditioning)

If the button  or  is pressed on the front control panel, air flows from the central and side vents in the rear of the vehicle.

If the button  is pressed on the front control panel, air flows into the footwells in the rear of the vehicle.

For information on MONO mode:

- ▷ Please see the chapter “ACCEPTING SETTINGS FOR DRIVER’S SIDE FOR THE ENTIRE VEHICLE” on page 74.

For information on REAR mode:

- ▷ Please see the chapter “ADJUSTING REAR AIR-CONDITIONED AREAS WITH THE FRONT CONTROL PANEL – REAR MODE (4-ZONE AIR CONDITIONING)” on page 81.



Disabling control panel for rear air-conditioned areas (4-zone air-conditioning)

The power window buttons on the rear doors and the rear control panel on the center console can be deactivated by pressing the safety button in the keypad on the driver’s door.

Switching child protection on/off

- ▷ Press the safety button  to switch child protection on and off.
The indicator light on the button lights up.
A lock symbol appears in the displays on the operating unit for the rear air-conditioned areas.



Adjusting rear air-conditioned areas with the front control panel – REAR mode (4-zone air conditioning)

Switching on REAR mode

- ▷ Press button **AUTO REAR** and keep it pressed for approx. 2 seconds. REAR appears on the air-conditioning display. The rear air-conditioned areas can be controlled from the front control panel.

Switching off REAR mode

- ▷ Press button **AUTO REAR** and keep it pressed for approx. 2 seconds. REAR disappears from the display.

Note on operation

- ▷ The function is ended automatically approximately 4 seconds after the last settings are adjusted.

Recommended air-conditioning settings for lone drivers

MONO mode is recommended for maximum passenger compartment comfort.

For information on activating MONO mode:

- ▷ Please see the chapter “ACCEPTING SETTINGS FOR DRIVER'S SIDE FOR THE ENTIRE VEHICLE” on page 74.

Reducing the air quantity in the rear air-conditioned areas does not improve passenger comfort in the front areas (4-zone air-conditioning only).

For information on adjusting the air quantity:

- ▷ Please see the chapter “SETTING AIR QUANTITY” on page 79.

Extended ventilation panel

The extended ventilation panel on top of the dashboard can be activated or deactivated separately in the multi-function display on the instrument panel.

The air flow in the passenger compartment is more diffuse and less direct.

The automatic control on the air-conditioning system adjusts the air flow quantity automatically.

For information on activating the extended ventilation control:

- ▷ Please see the chapter “SETTING AIR CONDITIONING” on page 146.

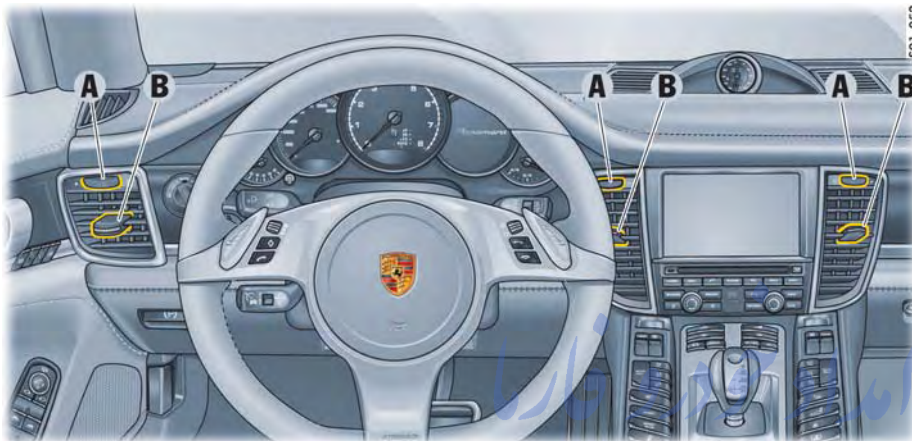

Front Air Vents

Air Vents

○ Opening air vents

- ▷ Turn thumb wheel **A** clockwise.

● Closing air vents

- ▷ Turn thumb wheel **A** counter-clockwise.

Changing air flow direction

- ▷ Swivel the air vent fins **B** in the desired direction.

FarmaSOS.com



Rear air vents

Fresh-air intake

To ensure unhindered air intake:

- ▷ Keep the fresh-air intake between the windshield and the engine compartment lid free from snow, ice and leaves.



Air vents, glove box

Cooled glove box

Cooled air is directed into the glove box via a separate air vent. The air vent can be opened and closed manually.

Note

Cold air may flow around the glove box lid and into the passenger compartment.

- ▷ If the outside temperature is low, close the air vents in the glove box to ensure the passenger compartment is heated as efficiently as possible.

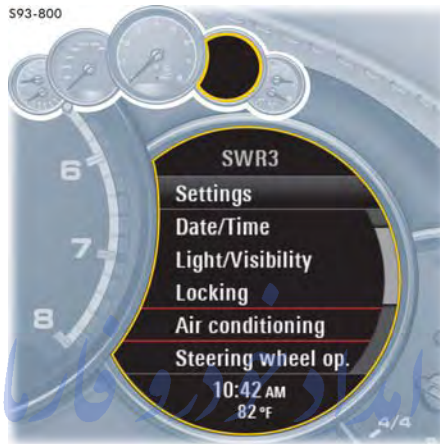

Multi-function display

Air-conditioning settings on the multi-function display

Additional settings relating to vehicle air-conditioning can be adjusted in the multi-function display on the instrument panel.

For information on air-conditioning settings on the multi-function display:

- ▷ Please see the chapter “SETTING AIR CONDITIONING” on page 146.

Air flow

Three air flow settings - “low”, “medium” and “high” - are available in automatic mode:

- **“Soft”**:
Recommended for passengers sensitive to drafts with a preference for gentle air-conditioning.
- **“Normal”**:
Default setting.
- **“Strong”**:
Stronger ventilation in the passenger compartment. The air flow is clearly noticeable.

Cooler central vents

The temperature of the air blown from the two central vents is reduced if the passenger compartment temperature control is not adjusted. This setting is recommended for passengers with a preference for a fresh air flow to the head/upper body area.

Extended ventilation panel

For information on the extended ventilation panel:

- ▷ Please see the chapter “EXTENDED VENTILATION PANEL” on page 81.

Automatic air-recirculation

For information on automatic air-recirculation mode:

- ▷ Please see the chapter “AIR-RECIRCULATION MODE” on page 74.



Switching off

- ▷ Press button .
The indicator light on the button goes out.

Note

On vehicles with heat-absorbing glass, optical distortion may occur due to the flat position of the rear window. This distortion is increased when the heated rear window is switched on.

Heated Rear Window/ Exterior Mirror Heating

Heated rear window/ exterior mirror heating is ready for operation when the ignition is on.

Switching on

- ▷ Press button .
The indicator light on the button lights up.

Depending on the outside temperature, the heating switches off automatically after approx. 5 to 20 minutes.

The heating can be switched back on by pressing the button again.

Windows and Slide/Tilt Roof

Power Windows.....	86
Slide/Tilt Roof.....	88

امداد خودرو فارما

تلفن شبانه روزی: ۰۲۱-۸۸۸۶۲۰۸۵

FarmaSOS.com

Power Windows

Warning!

Risk of injury when closing the windows, especially when windows close automatically.

- ▷ Take care to ensure that nobody can be injured when the windows close.
- ▷ Always remove ignition key when leaving the vehicle or switch ignition off on vehicles with Porsche Entry & Drive. Always take the ignition key with you when leaving the vehicle. Uninformed persons could injure themselves by operating the power windows.
- ▷ In case of danger, immediately release the button on the ignition key or the button in the door handle on vehicles with Porsche Entry & Drive.
- ▷ Do not leave children in the vehicle unattended.

Risk of an accident.

- ▷ Do not put anything on or near the windows that may interfere with the driver's vision.

Readiness for operation of power windows

- With ignition switched on.
- A maximum of 10 minutes after the ignition is switched off, but only until driver's or passenger door is first opened.
- The one-touch operation for closing the door windows is available only when the ignition is switched on.

امداد خودرو فارما

تلفن شبانه روزی: ۰۲۱-۸۸۸۶۲۰۸۵

FarmaSOS.com

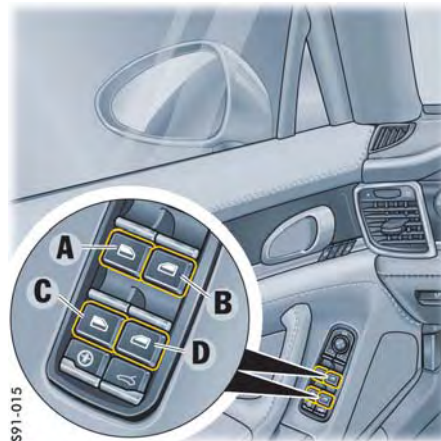

- A** - Power window in driver's door
- B** - Power window in passenger's door
- C** - Left rear power window
- D** - Right rear power window

Opening/closing windows

Opening window with the rocker switch

- ▷ Press rocker switch **A**, **B**, **C** or **D** until the window has reached the desired position.

Closing window with the rocker switch

- ▷ Pull rocker switch **A**, **B**, **C** or **D** until the window has reached the desired position.



Power window switch in the passenger's door

Note on operation

The rocker switches have a two-stage function:

- If the switch in question is moved to the first setting, the window is opened or closed manually.
- If the switch is moved completely to the second setting, the front window is opened or closed automatically (one-touch operation). Actuate the switch again to stop the window in the desired position.



Power window switch in the rear door

Note on operation

If a window is blocked during closing, it will stop and open again by several inches.
 If the window is blocked a second time within approximately 10 seconds, one-touch operation is disabled for this window.

The window can be closed manually. The window then closes with its full closing force.

One-touch operation is enabled again once the window has been closed completely using the manual closing function.

Warning!

Risk of injury. If one-touch operation is disabled after the window is blocked, the window will close with its full closing force when the manual closing function is used.

- ▷ Take care to ensure that nobody can be injured when the windows close.



Storing end position of the door windows after connecting the vehicle battery

The end position of the door windows are lost when the battery is disconnected and reconnected. One-touch operation of the windows is disabled.

Perform these steps for all windows:

1. Close window completely **once** by pulling the rocker switch.
2. If the window is completely closed, briefly pull the rocker switch again.
3. Open the window completely **once** by pressing the rocker switch.

Disabling the controls in the rear

The power window buttons on the rear doors and the control panel on the rear center console can be disabled by pressing the safety button in the control panel on the driver's door.

Switching child protection on/off

- ▷ Press the safety button.
The indicator light in the safety button lights up if child protection is active.

Slide/Tilt Roof

The electric slide/tilt roof is made of tinted single-sheet safety glass. It has a sliding roof cover that can be continuously adjusted manually to protect against the direct entry of sunlight.

The slide/tilt roof can be slid open or lifted at the rear.

Warning!

Risk of injury when operating or automatically closing the slide/tilt roof.

- ▷ Take care to ensure that nobody can be injured when the slide/tilt roof is operated.
- ▷ Always remove ignition key when leaving the vehicle or switch ignition off on vehicles with Porsche Entry & Drive. Always take the ignition key with you when leaving the vehicle. Uninformed persons (e.g. children) could injure themselves when operating the slide/tilt roof.
- ▷ In case of danger, operate the sliding roof button in the opposite direction or release the car key immediately if using the comfort function.

تلفن شبانه روزی: ۰۲۱-۸۸۶۲۰۸۵

FarmaSOS.com

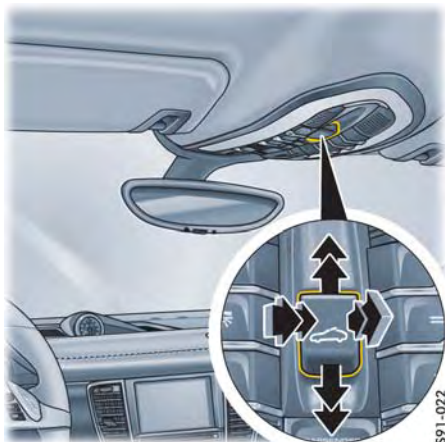

Operating slide/tilt roof

The slide/tilt roof is operated using the button  in the overhead operating console.

The sliding roof button has a two-stage function for all directions of motion:

- If the button is moved to the first setting in one direction, the slide/tilt roof is adjusted manually in the relevant direction. Adjustment stops when the button is released.
- If the button is moved completely to the second setting, the slide/tilt roof is opened or closed automatically (one-touch operation). Actuate the switch again in any direction to stop the slide/tilt roof in the desired position.

Operational readiness of the slide/tilt roof

- With ignition switched on.
- A maximum of 10 minutes after the ignition is switched off, but only until driver's or passenger door is first opened.

Note on operation

The slide/tilt roof has a force limiter. If obstructed during the closing process, the slide/tilt roof opens again immediately.

Reduced-noise position when opening

The slide/tilt roof slides open both in manual mode and one-touch operation mode until it reaches the best position from the point of view of wind noise.

Opening slide/tilt roof fully

Actuate the button  again in opening direction to open the slide/tilt roof completely. When completely opened, the slide/tilt roof may generate wind noise depending on the speed of the vehicle.

Emergency operation of slide/tilt roof



Warning!

Risk of serious personal injury and damage to the slide/tilt roof when closing the slide/tilt roof.

- ▷ Take care to ensure that nobody can be injured when the slide/tilt roof is operated.

Emergency closing after repeated intervention from the force limiter

- ▷ Remove the obstruction.
- ▷ Repeatedly press or press and hold the sliding roof button  in closing direction until the roof closes and stops in closed position.

Emergency operation if the slide/tilt roof drive fails

If the slide/tilt roof is defective, it can be closed or opened manually using the hexagon key from the tool kit.

- ▷ Before using emergency operation, check that the fuse is intact.

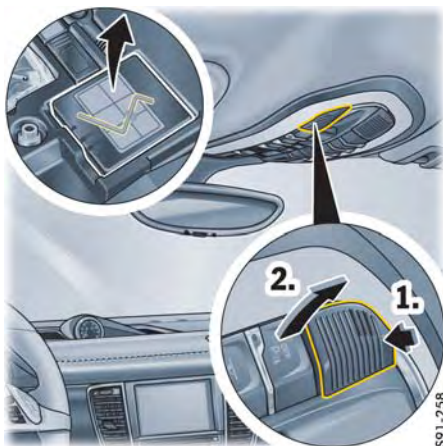

1. Press lightly on the front tip of the cover over the left passenger compartment monitoring sensor.
The opposite end of the cover lifts up.
 2. Unclip cover.
- ▷ Take the hexagon key out of the tool kit in the luggage compartment.

For information on the tool kit:

- ▷ Please see the chapter "TOOL KIT" on page 279.

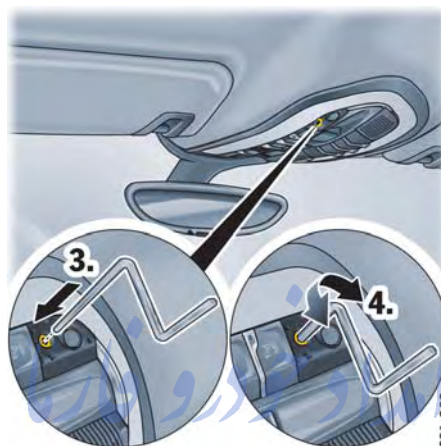

3. Insert the hexagon key all the way into the opening.
 4. Hold the key in this position and turn.
 5. Remove the key.
Stow the key in the tool kit.
 6. Clip in cover.
- ▷ Have the fault corrected.
Please contact a qualified specialist workshop. We recommend that you have an authorized Porsche dealer to do this work as they have trained workshop personnel and the necessary parts and tools.

Storing end position of the slide/tilt roof

The end position of the slide/tilt roof are lost if the vehicle battery is disconnected/reconnected or flat, the vehicle is started using jump leads, the electrical fuse for the slide/tilt roof is replaced or after emergency operation.



Warning!

Risk of injury when closing the slide/tilt roof. When the end position is stored, the force limiter is not available and the slide/tilt roof will close with full force.

- ▷ Take care to ensure that nobody can be injured when the slide/tilt roof closes.

The vehicle must be stationary to store the end position of the slide/tilt roof.

1. Switch on ignition.
2. Press the button  forwards in closing direction and hold in position.
The process for storing the end position begins after approximately 10 seconds. Press and hold the button until the roof has stopped moving completely.
The process takes a maximum of 20 seconds. Start the storing process again if the button is released prematurely.

Lights, Turn Signals and Windshield Wipers

Automatic Driving Light Assistant/ Adaptive Light System	92
Instrument lighting	95
Turn Signal/High Beam/Headlight Flasher Stalk	96
Emergency Flasher	97
Interior Lighting	98
Brief Overview – Windshield Wipers	101
Windshield Wiper/Washer Stalk	102

امداد خودرو فارما

تلفن شبانه روزی: ۰۲۱-۸۸۸۶۲۰۸۵

FarmaSOS.com



Light Switch

- **Light is switched off.**

The daytime driving lights are switched on when the ignition is switched on, provided that they are activated on the multi-function display in the instrument panel.

For information on activating/deactivating daytime driving lights:

- ▷ Please see the chapter “ACTIVATING AND DEACTIVATING AUTOMATIC DAYTIME DRIVING LIGHTS” on page 142.

AUTO Automatic driving light assistant

Side lights

Side marker lights, licence plate light, instrument lighting, daytime driving lights switched off.

Low beam/driving light

Only with ignition on.

Rear fog light

Pull the switch in the low beam position. Indicator light lights up.

Note on operation

If the ignition key is removed and the door is opened while the lights are on, an audible signal (gong) warns of possible battery discharge.

In some countries, differences are possible due to legal requirements.

تلفن شبانه روزی: ۰۲۱-۸۸۶۲۰۸۵

FarmaSOS.com

Automatic Driving Light Assistant/ Adaptive Light System

The automatic driving light assistant is a comfort function. Your Porsche's driving light (low beam) is switched on and off automatically depending on the ambient brightness.

The automatic driving light assistant also controls the daytime driving lights, the Automatic Coming Home lights and the dynamic cornering light.

The automatic driving light assistant is activated when the light switch is set to the position **AUTO**.

Despite possible support by the driving light assistant, it is the responsibility of the driver to switch on the driving light using the conventional light switch in accordance with the relevant national regulations.

Activating the headlights using the driving light assistant therefore does not absolve the driver of responsibility for correct operation of the driving light.

Warning!

Risk of accidents if you drive your vehicle without lights.

- ▷ Always carefully monitor the automatic driving light control.

Note

In the event of a fault in the automatic driving light assistant/adaptive light system, the warning light for the adaptive light system lights up in the instrument panel and a warning message appears on the multi-function display in the instrument panel.

For information on indicator lights and warning lights on the instrument panel:

- ▷ Please see the chapter “INSTRUMENT PANEL USA MODELS” on page 107.

For information on warning messages on the multi-function display:

- ▷ Please see the chapter “OVERVIEW OF WARNING MESSAGES” on page 152.

Low beam/driving light

If the light switch is set to the position **AUTO**, the low beam is switched on automatically in the following situations:

- Dusk
- Darkness
- Driving through tunnels
- Rain
- Highway driving (daytime driving lights deactivated)

When the low beam is switched on, the indicator light on the speedometer lights up.

Note on operation

Fog is not recognized.

- ▷ In the event of fog, the headlights must تلفن be switched on manually.

Highway function in daylight

The low beam is switched on automatically at vehicle speeds of more than approx. 90 mph (140 km/h) in daylight conditions and when daytime driving lights are deactivated. If the vehicle is travelling at speeds of less than approx. 40 mph (65 km/h), the low beam switches off after a delay of approx. 4 minutes, if the external lighting conditions permit.

Highway function in darkness

The distribution characteristics of the low beam change if the vehicle is travelling at speeds of more than approx. 80 mph (130 km/h) in darkness.

The light beam becomes longer and the field of vision increases.

Rain function

The low beam is switched on automatically after five seconds of continuous wiper operation.

If the wipers have not been used for approx. 4 minutes, the low beam is switched off.

Automatic headlight levelling

When the ignition and low beam are switched on, the level of the headlight beam automatically changes in accordance with the vehicle load. The level of the headlight beam is automatically kept constant during acceleration and braking.

Note on operation

Automatic headlight levelling is also available when the light switch is set to the position  (low beam/driving light).

Daytime driving lights

If the light switch is in position **•** (light switched off), the daytime driving lights are switched on automatically when the ignition is switched on.

If the light switch is in position **AUTO**, the daytime driving lights are switched on automatically during daylight when the ignition is switched on.

If the light switch is in position  (low beam/driving light), the daytime driving lights are not active.

You can switch the daytime driving lights on and off on the multi-function display in the instrument panel (not available in Canada).

Regulations for switching daytime driving lights on and off vary according to the legal requirements in each country.

For information on setting the daytime driving lights:

- ▷ Please see the chapter “ACTIVATING AND DEACTIVATING AUTOMATIC DAYTIME DRIVING LIGHTS” on page 142.

Static cornering light

The static cornering light switches on if the steering wheel is turned sharply.

Note on operation

The static cornering light is also available when the light switch is set to the position  (driving light/low beam).

Dynamic cornering light

At speeds greater than 5 mph (8 km/h), the low beam light is swivelled in the direction of the curve to illuminate the road more clearly, depending on the speed of the vehicle and the extent to which the steering wheel is turned.

In the event of a fault in the dynamic cornering light, the warning light for the adaptive light system flashes in the instrument panel and a warning message appears on the multi-function display in the instrument panel.

For information on indicator lights and warning lights on the instrument panel:

- ▷ Please see the chapter “INSTRUMENT PANEL USA MODELS” on page 107.

For information on warning messages on the multi-function display:

- ▷ Please see the chapter “OVERVIEW OF WARNING MESSAGES” on page 152.

Automatic Coming Home lights (Welcome Home function/Entry function)

Switching on Automatic Coming Home lights

- ▷ Set light switch to **AUTO**.

The following lights remain switched on for a certain period to allow you to get in and out of your vehicle safely and with improved visibility in darkness:

- Daytime driving lights,
- Courtesy lights in the exterior mirrors (on vehicles with comfort memory),
- Front and rear side marker lights,
- Licence plate lights.

Welcome Home function (off delay)

When the vehicle is locked, the lights remain switched on for the duration of the off delay preset on the multi-function display.

For information on adjusting the off delay of the external lights on the multi-function display:

- ▷ Please see the chapter "ADJUSTING EXTERIOR LIGHTS" on page 142.

Entry function

When the vehicle is unlocked, the area around the vehicle is illuminated for the duration of the off delay preset on the multi-function display.

The lights are switched off when the ignition is switched on or the light switch is set to a position other than **AUTO**.

For information on adjusting the off delay of the external lights on the multi-function display:

- ▷ Please see the chapter "ADJUSTING EXTERIOR LIGHTS" on page 142.

امداد خودرو فارما

تلفن شبانه روزی: ۰۲۱-۸۸۸۶۲۰۸۵

FarmaSOS.com



Instrument lighting

The lighting is automatically adjusted to the ambient brightness by the light sensor **B**. In addition, when the vehicle lighting is switched on, the instrument and switch brightness can be adjusted manually.

- ▷ Turn adjustment button **A** in the appropriate direction and hold until the desired brightness has been reached.

Warning!

Risk of accident when adjusting brightness while driving. You may lose control of the vehicle.

- ▷ Do not reach through the steering-wheel spokes when driving.



Turn Signal/High Beam/Headlight Flasher Stalk

Turn signals, low beam and high beam are ready for operation when the ignition is on.

- 1 – Turn signal light, left**
- 2 – Turn signal light, right**

Push the stalk to the upper or lower pressure point – turn signal lights flash three times

- 3 – High-beam headlight**
- 4 – Headlight flasher**

Stalk in center position – low beam

When the high beam is switched on or the headlight flasher is operated, the blue indicator light on the speedometer lights up.

Parking light

The parking light can only be switched on when the ignition is switched off.

- ▷ Move the stalk up or down to switch on the right or left parking light.

If the parking light is switched on, the message “Parking light on” will appear on the multi-function display in the instrument panel after the ignition is switched off.

For information on warning messages on the multi-function display:

- ▷ Please see the chapter “OVERVIEW OF WARNING MESSAGES” on page 152.

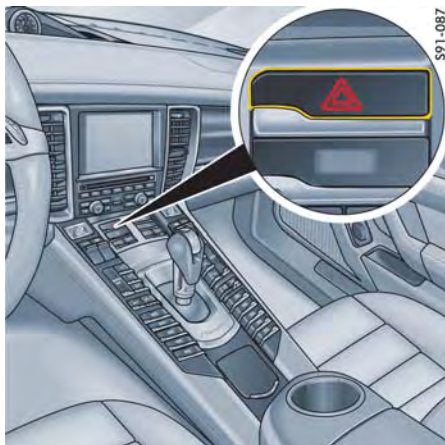

Emergency Flasher

The emergency flasher can be switched on regardless of the position of the ignition lock.

Switching on and off

- ▷ Press the emergency flasher button on the center console.

All turn signal lights and the indicator light in the button flash when the button is operated.

If the emergency flasher remains active for longer periods, the illumination phase of the flashing interval is shortened to preserve the lights.

Automatic activation of hazard warning lights in the event of an accident

The emergency flasher is activated automatically in the event of an accident.

- ▷ To deactivate the emergency flasher, switch off the ignition, wait approx. 5 seconds and then switch the ignition back on again.

For information on switching the ignition on and off:

- ▷ Please see the chapter "IGNITION LOCK, STEERING LOCK" on page 164.

امداد خودرو فارما

تلفن شبانه روزی: ۰۲۱-۸۸۸۶۲۰۸۵

FarmaSOS.com

Danger!

Risk of an accident resulting in serious personal injury or death.

- ▷ Whenever stalled or stopped for emergency repairs, move the car well off the road. Switch on the emergency flasher and mark the car with road flares or other warning devices.
- ▷ Do not remain in the car. Someone approaching from the rear may not realize your vehicle is stopped and cause a collision.

Danger of fire.

- ▷ Do not park or operate the vehicle in areas where the hot exhaust system may come in contact with dry grass, brush, fuel spill or other flammable material.

Hot engine compartment components can burn skin on contact.

- ▷ Before working on any part in the engine compartment, turn the engine off and let it cool down sufficiently.

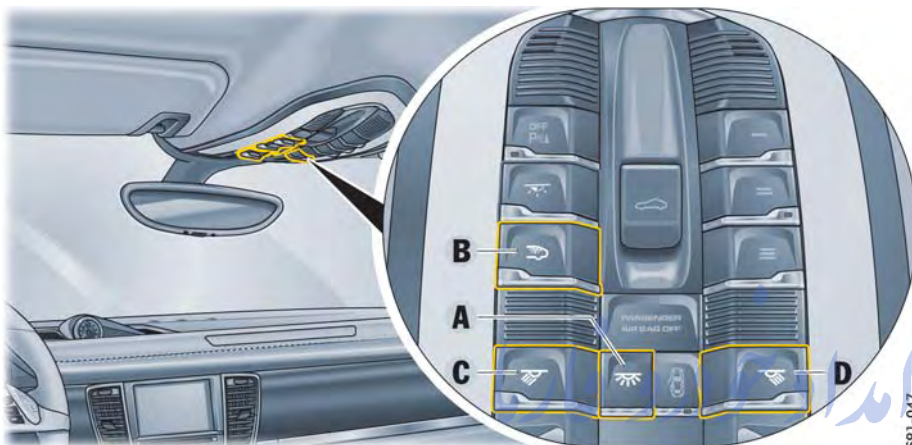

- A - Button for front interior light
- B - Button for rear interior lights
- C, D - Button for front reading lights

Interior Lighting

Interior lights

Switching front interior light on and off

- ▷ Press button **A**.

Switching rear interior light on and off

- ▷ Press button **B** in the front overhead operating console or button **E** above the relevant door.

Dimming (brightness adjustment)

- ▷ Press button **A** for the front interior light or button **E** for the relevant rear interior light and hold for at least 1 second until the desired level of brightness is reached.

Reading lights

Switching front reading lights on and off

- ▷ Press button **C** or **D**.

Switching rear reading lights on and off

- ▷ Press button **E** above the relevant door.



- E - Button for rear reading and interior lights

Dimming (brightness adjustment)

- ▷ Press button **C** or **D** for the front reading light or button **E** for the relevant rear reading light and hold for at least 1 second until the desired level of brightness is reached.



Switching automatic interior lighting on and off

- ▷ Press button **A**.

When the automatic interior lighting is switched off, the indicator light in the button lights up.

When the automatic interior lighting is switched on, in darkness the interior lighting is

- **switched on** when a door is unlocked or opened, when the ignition key is removed from the ignition lock or when the steering wheel is locked on vehicles with Porsche Entry & Drive.

- **switched off** when the door is closed, after a delay of approx. 120 seconds. The off delay time can be preset on the multi-function display. The interior lighting goes out as soon as the ignition is switched on or the vehicle is locked.

For information on setting the off delay for the interior light:

- ▷ Please see the chapter “SETTING INTERIOR LIGHTING OFF DELAY” on page 143.

امداد خودرو فارما

تلفن شبانه روزی: ۰۲۱-۸۸۸۶۲۰۸۵

FarmaSOS.com

Orientation lighting

Lights in the front operating console, the inner door handles, the storage trays and the rear light units help vehicle occupants to locate important controls in the vehicle in darkness and ensure better overall orientation. The lights are switched on when the vehicle is unlocked and switched off again automatically when the vehicle is locked.

Dimming (brightness adjustment)

The brightness of the orientation lighting is adjusted on the multi-function display.

For information on adjusting the brightness of the orientation lighting:

- ▷ Please see the chapter “ADJUSTING BRIGHTNESS OF ORIENTATION LIGHTING” on page 143.

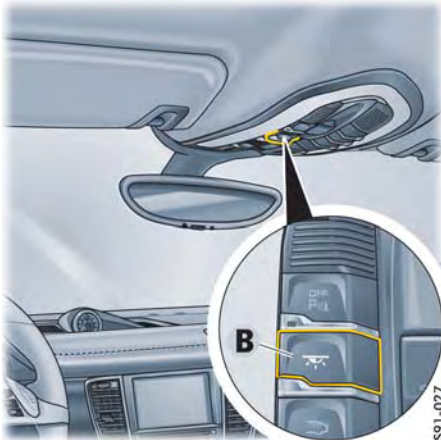

Automatic interior light switch-off function

In darkness, the interior lighting is switched off 16 minutes after the engine stops to preserve the vehicle battery.

In daylight conditions, interior lights that were switched on manually are switched off automatically after 1 minute.

امداد خودرو فارما

Ambient lighting

If the vehicle is driven at night, a discreet light provides subtle illumination for the passenger compartment. The ambient lighting is switched off automatically when the vehicle is locked.

تلفن شبانه روزی: ۰۲۱-۸۸۸۶۲۰۸۵

Switching ambient lighting on and off

- ▷ Press button **B**.

Dimming (brightness adjustment)

- ▷ Press button **B** for dimming the ambient lighting and hold for at least 1 second until the desired level of brightness is reached.

FarmaSOS.com

Brief Overview – Windshield Wipers

This brief overview does not replace the information provided under “WINDSHIELD WIPER/WASHER STALK”.

Warnings, in particular, are not replaced by this brief overview.

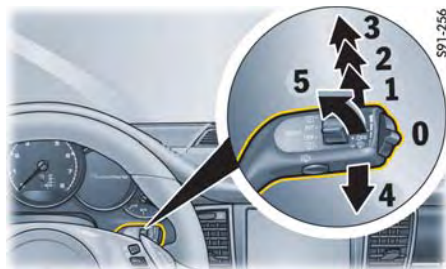

Windshield wiper stalk

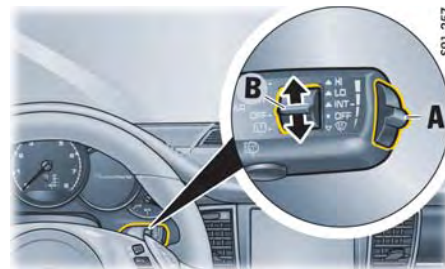

Switches for wiping interval (A) and rear wiper (B)

What do I want to do?

Wipe automatically at front (rain sensor/intermittent operation)

What do I have to do?

Press the stalk to detent position **1**.

Adjust the rain sensor/wipe interval

Adjust switch **A** on the right of the stalk upwards (wipe more often) or downwards (wipe less often).

Wipe at front

Slow: Press the stalk to detent position **2**.
 Fast: Press the stalk to detent position **3**.
 Once: Briefly move stalk to position **4** (holding stalk in position **4** accelerates wiping action).

Spray and wipe at front

Pull stalk to position **5** and hold.

Wipe at rear (intermittent wiping)

Push switch **B** upwards to detent position **INT**.

Wipe at rear (wipe once)

Push switch **B** all the way up or down.

Windshield Wiper/Washer Stalk

Caution!

Danger of injury if the windshield wipers operate unintentionally.

Risk of damage to the engine compartment lid, windshield and wiper system.

- ▷ Only wipe the windshield when sufficiently wet, otherwise it could become scratched.
- ▷ Loosen frozen wiper blades before starting to drive.
- ▷ Do not operate a frozen headlight washer system.
- ▷ Always switch off windshield wipers in car washes to prevent them wiping unintentionally (rain sensor operation).
- ▷ Do not operate headlight washer system in car washes.
- ▷ Always switch off windshield wipers before cleaning the windshield to avoid unintentional operation (rain sensor operation).
- ▷ Always hold the wiper arm securely when replacing the wiper blade.
- ▷ Always switch off windshield wipers before opening the engine compartment lid (wiper switch in position **O**).

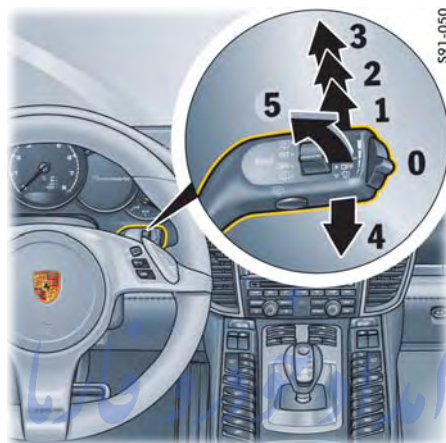

Front wiper and headlight washer system

0 – Windshield wipers off

When the windshield wipers are switched off, the wipers move up slightly from their rest position so that the wiping edges are aligned correctly.

1 – Rain sensor operation

Front windshield wipers

Move wiper stalk upwards to the first click.

2 – Front windshield wipers – slow

Move wiper stalk upwards to the second click.

3 – Front windshield wipers – fast

Move wiper stalk upwards to the third click.

4 – Front windshield wipers – one-touch operation

Move wiper stalk downwards.

The front windshield wipers carry out one wiping cycle.

5 – Front windshield wiper and washer system

Pull wiper stalk towards the steering wheel. The washer system wipes and sprays while the stalk is pulled towards the steering wheel.

When the wiper stalk is released, a few drying wipes are performed.

After every 10 wipes on the windshield, the headlights are cleaned automatically.

Maintenance notes

- ▷ If heavily soiled, repeat wash.
- ▷ Persistent dirt (e.g. insect remains) should be removed regularly.

For information on car care:

- ▷ Please see the chapter “CAR CARE INSTRUCTIONS” on page 269.

The **front windshield washer nozzles** are heated when the ignition is on, as a precaution against freezing. However, this does not replace the use of antifreeze.



S91-067

Rain sensor operation, front windshield wipers

In rain sensor mode, the amount of rain on the windshield is measured. Wiper speed is automatically adjusted accordingly.

At a speed of less than approx. 2 mph (4 km/h), rain sensor operation is automatically activated if the windshield wiper is switched on. If you exceed a speed of approx. 5 mph (8 km/h), the system changes to the preselected wiper speed.

The rain sensor remains switched off if the wiper stalk is already in position **1** when the ignition is switched on.

To switch the rain sensor on again:

- ▷ Move wiper stalk to position **0** and then to position **1**
Switch-on is confirmed by one wipe of the windshield.
or
Operate windshield washer system **5**.
Switch-on is confirmed by three wipes of the windshield.
or
Change the sensitivity of the rain sensor using switch **A**.

Note on operation

In the multi-function display on the instrument panel, you can configure the rain sensor to activate automatically when the ignition is switched on and the wiper stalk is set to position **1**.

For information on adjusting rain sensor activation when the ignition is switched on:

- ▷ Please see the chapter “SETTING RAIN SENSOR ACTIVATION” on page 143.

Adjusting the rain sensor sensitivity

- ▷ Move switch **A** upwards – high sensitivity.
The setting is confirmed by one wipe of the windshield.
- ▷ Move switch **A** downwards – low sensitivity.

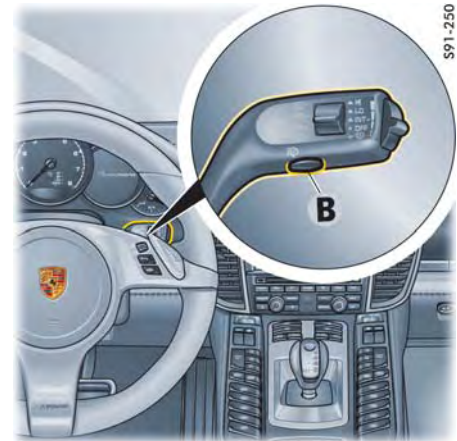

S91-250

Headlight washer system

The washer sprays only while low beam or high beam is activated.

- ▷ Press button **B** under the wiper stalk.

After every 10 wipes on the windshield, the headlights are cleaned automatically as well. The wipe count starts from zero again when the low beam is switched off.



Rear window wiper

Switching on intermittent operation of rear window wiper

- ▷ Push switch **C** upwards to detent position **INT.**

Switching off intermittent operation of rear window wiper

- ▷ Push switch **C** downwards to detent position **OFF.**

Manual wiping

- ▷ Push switch **C** on the wiper stalk all the way down from detent position **OFF** or all the way up from detent position **INT.**
The washer system wipes as long as the switch is pressed down.

Switching on the rear window wiper when reverse gear is engaged

In the multi-function display, you can configure the rear wiper to automatically perform a series of wipes when it rains or when the windshield wipers are used while reverse gear is engaged.

For information on configuring the automatic function for activating the rear wiper when reverse gear is engaged:

- ▷ Please see the chapter “SETTING ACTIVATION OF THE REAR WIPER WHEN REVERSE GEAR IS ENGAGED” on page 143. *تلفن شبانه روزی: ۵*

Maintenance note

- ▷ Clean the wiper blades with window cleaner at regular intervals, especially after washing the vehicle in a car wash.
We recommend Porsche window cleaner. If the wiper blades are very dirty (e. g. soiled with insect remains), they can be cleaned with a sponge or cloth.

If the wiper blades rub or squeak, this may be due to the following:

- If the vehicle is washed in an automatic car wash, wax residues may adhere to the windshield. These wax residues can be removed only by using window cleaner concentrate.

- ▷ Please see the chapter “WASHER FLUID” on page 259.

Contact your authorized Porsche dealer for more information.

- The wiper blades may be damaged or worn.
- ▷ Replace damaged wiper blades immediately.

FarmaSOS.com

Instrument Panel and Multi-Function Display

Instrument Panel USA Models.....	107
Instrument Panel Canada Models	109
Tachometer	110
Speedometer	110
Multi-Function Display	110
Engine Oil Temperature Gauge	110
Coolant Temperature Gauge	110
Engine Oil Pressure Gauge.....	111
Fuel Gauge	111
Digital Speedometer.....	112
Upshift Prompt Indicator	112
Odometer	112
Reset Button for Trip Counter Display/ Brightness Setting for Instrument Lighting...	112
PDK Display for Selector-Lever Position/ Engaged Gear.....	112
Battery/Alternator	113
Check Engine (Emission Control)	114
Acoustic Signals	114
Operating the Multi-Function Display in the Instrument Panel	115
Vehicle Settings on the Multi-Function Display	138
Overview of Warning Messages	152

امداد خودرو فارما

تلفن شبانه روزی: ۰۲۱-۸۸۸۶۲۰۸۵

FarmaSOS.com

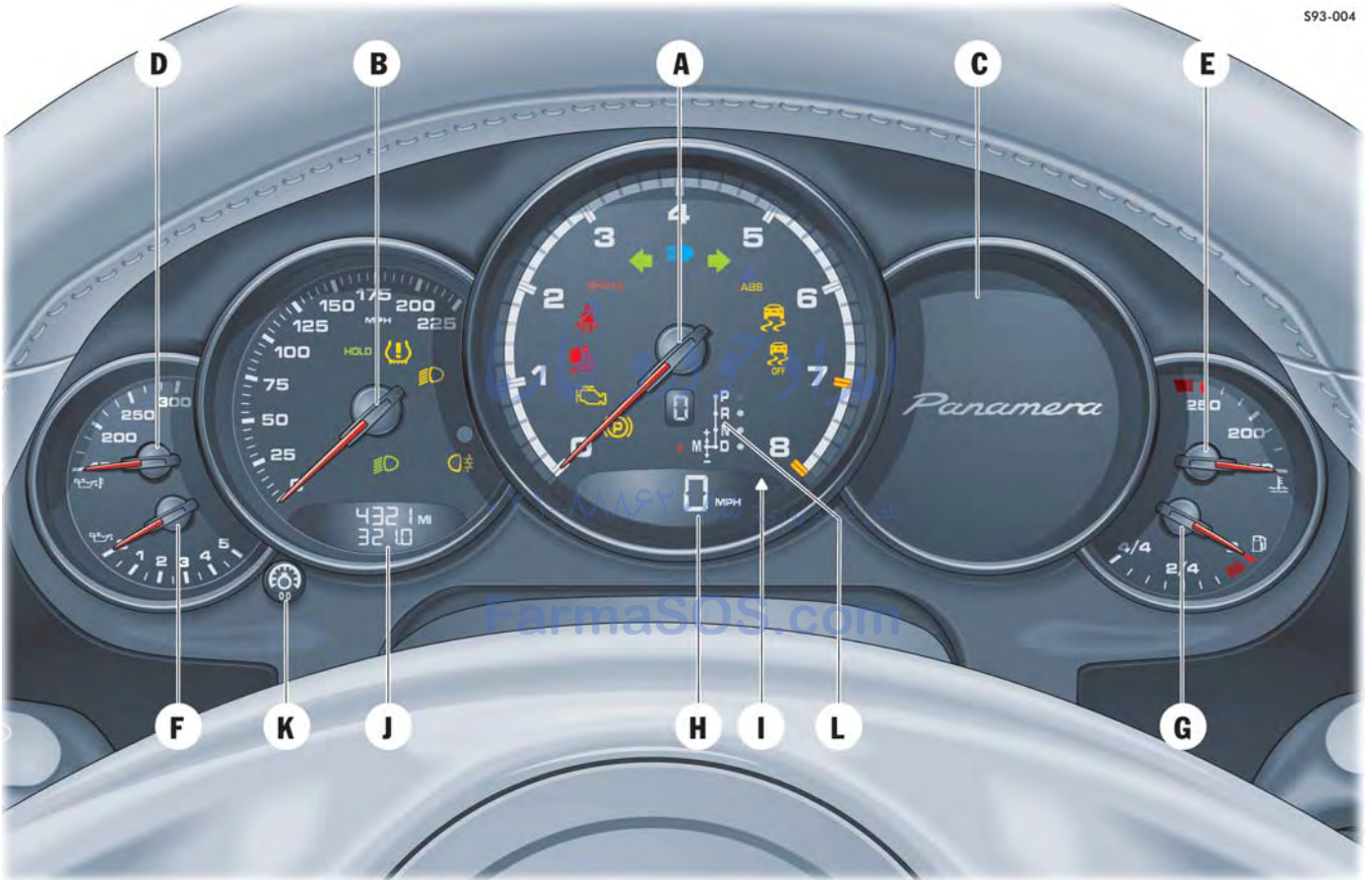





- A Tachometer
- B Speedometer
- C Multi-function display
- D Engine oil temperature gauge
- E Coolant temperature gauge
- F Engine oil pressure gauge
- G Fuel gauge
- H Digital speedometer
- I Upshift prompt indicator
- J Odometer
- K Reset button for trip counter display/
Brightness setting for instrument panel
- L PDK indicator for selector-lever position/
engaged gear

Instrument Panel USA Models

Warning and indicator lights on the tachometer

-  Emission control warning light (Check Engine)
-  Air bag warning light
-  Seat belt warning light
-  PSM warning light
-  PSM OFF warning light
-  ABS warning light
-  Turn signal, left
-  Turn signal, right
-  BRAKE Brake warning light
-  High beam indicator light
-  Electric parking brake warning light

Warning and indicator lights on the speedometer

-  Rear fog light indicator light
-  HOLD HOLD function indicator light
-  Low beam indicator light
-  Adaptive light system warning light
-  Tire pressure warning light

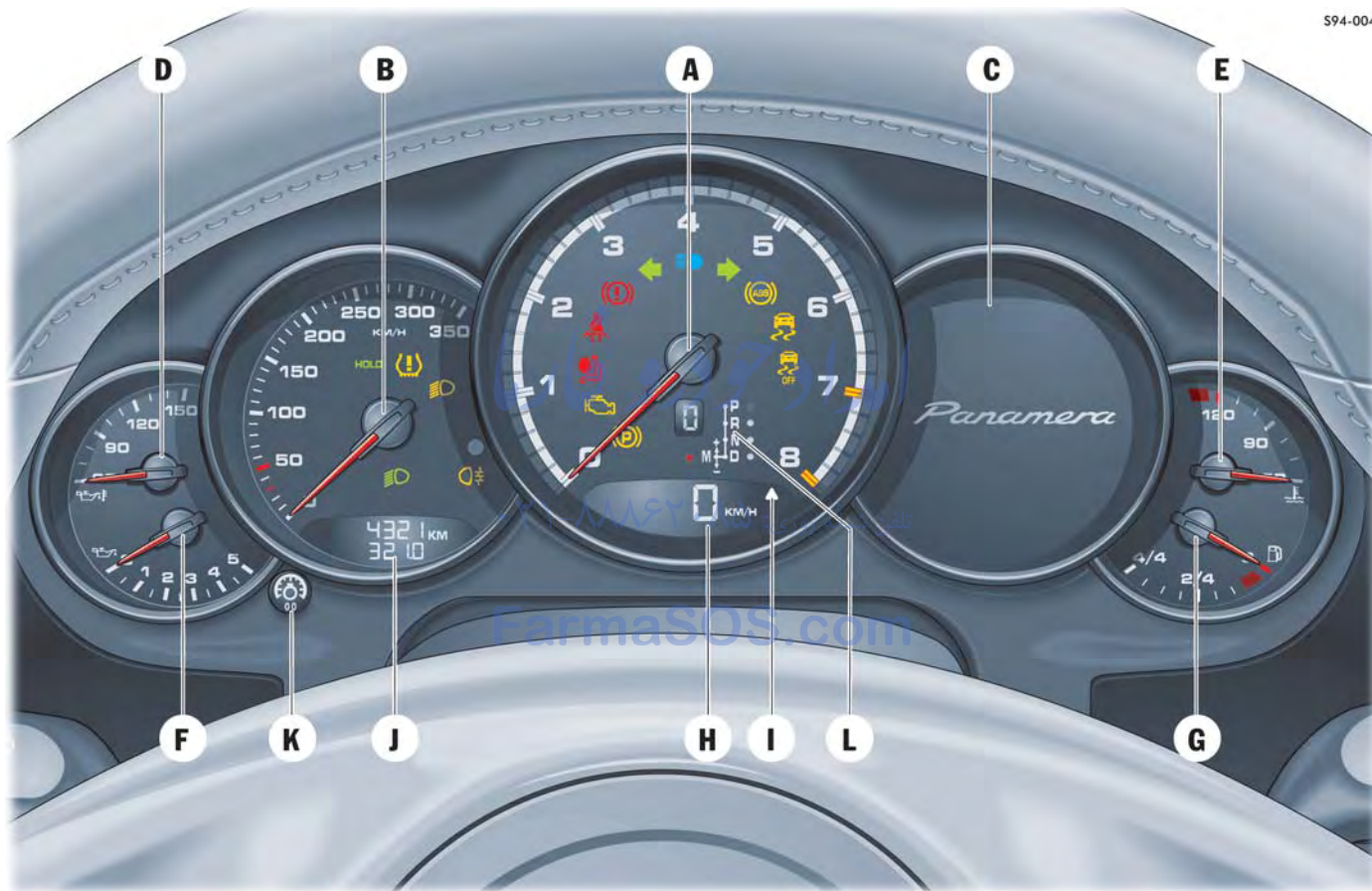





- A Tachometer
- B Speedometer
- C Multi-function display
- D Engine oil temperature gauge
- E Coolant temperature gauge
- F Engine oil pressure gauge
- G Fuel gauge
- H Digital speedometer
- I Upshift prompt indicator
- J Odometer
- K Reset button for trip counter display/
Brightness setting for instrument panel
- L PDK indicator for selector-lever position/
engaged gear

Instrument Panel Canada Models

Warning and indicator lights on the tachometer

-  Emission control warning light (Check Engine)
-  Air bag warning light
-  Seat belt warning light
-  PSM warning light
-  PSM OFF warning light
-  ABS warning light
-  Turn signal, left
-  Turn signal, right
-  Brake warning light
-  High beam indicator light
-  Electric parking brake warning light

Warning and indicator lights on the speedometer

-  Rear fog light indicator light
-  HOLD function indicator light
-  Low beam indicator light
-  Adaptive light system warning light
-  Tire pressure warning light

A – Tachometer

The start of the red zone on the tachometer or rev-counter scale is a visual warning of the maximum permissible engine speed.

If the red zone is reached during acceleration, fuel feed is interrupted in order to protect the engine.

B – Speedometer

The analogue display **B** is located on the left next to the tachometer in the instrument panel.

C – Multi-Function Display

For information on the multi-function display:

- ▷ Please see the chapter “OPERATING THE MULTI-FUNCTION DISPLAY IN THE INSTRUMENT PANEL” on page 115.

D – Engine Oil Temperature Gauge

A warning message will appear on the multi-function display in the instrument panel if the engine oil temperature is too high.

- ▷ Reduce engine speed and engine load immediately if the red zone is reached.

For information on warning messages on the multi-function display:

- ▷ Please see the chapter “OVERVIEW OF WARNING MESSAGES” on page 152.

E – Coolant Temperature Gauge

If the cooling system is in any way faulty, consult a qualified specialist workshop. We recommend that you have an authorized Porsche dealer to do this work, as they have the trained workshop personnel and the necessary parts and tools for this type of work.

Pointer in the lower area – engine cold

- ▷ Avoid high engine speeds and heavy engine loading.

Pointer in the middle – normal operating temperature

Pointer may move up to the red area when engine is heavily loaded and outside temperature is high.

Coolant temperature warning

The temperature gauge warning light will illuminate if the coolant temperature is too high. The warning message “Engine temperature too high” will also appear on the multi-function display in the instrument panel.

- ▷ Switch off engine and allow to cool.
- ▷ Check radiators and air guides in front end of vehicle for obstructions.
- ▷ Check the coolant level. Top up with coolant if necessary.
- ▷ Have the fault corrected.
- ▷ Please see the chapter “CHECKING COOLANT LEVEL AND ADDING COOLANT” on page 257.
- ▷ Please see the chapter “OVERVIEW OF WARNING MESSAGES” on page 152.

Note on operation

To prevent excessive temperatures, the cooling air ducts must not be obstructed by covering them (e.g. with film, “stone guards”, etc.).

Coolant level warning

The temperature gauge warning light flashes if the coolant level is too low.

The warning message “Check coolant level” also appears on the multi-function display in the instrument panel

- ▷ Switch off engine and allow to cool.
- ▷ Add coolant.

If the coolant level is too low, warning indicators may light up if the vehicle tilts at an extreme angle (e.g. steep slopes) or generates high lateral acceleration while travelling round long bends (e.g. driving in circles). If the warnings do not disappear once the vehicle has assumed “normal” operating state, check the coolant level.

- ▷ Please see the chapter “CHECKING COOLANT LEVEL AND ADDING COOLANT” on page 257.
- ▷ Please see the chapter “OVERVIEW OF WARNING MESSAGES” on page 152.



Caution!

Risk of engine damage.

- ▷ Do not continue driving if the warning persists even when the engine coolant level is correct.
- ▷ Have the fault corrected.

F – Engine Oil Pressure Gauge

The oil pressure is controlled according to requirements and should be at least 29 psi (2.0 bar) at an engine speed of 3,000 rpm and at least 44 psi (3.0 bar) at an engine speed of 5,000 rpm.

The engine oil pressure varies depending on the engine speed, oil temperature and engine load.

If oil pressure drops abruptly and a message is displayed on the multi-function display when the engine is running or while driving:

- ▷ Stop immediately in a suitable place.
- ▷ Switch off the engine.
- ▷ Check whether there is an obvious oil leak on or under the car.
- ▷ Select “Oil level” on the multi-function display.
- ▷ Please see the chapter “OIL LEVEL DISPLAY AND MEASUREMENT OF THE ENGINE OIL LEVEL” on page 121.
- ▷ Add engine oil if necessary.



Caution!

Risk of engine damage.

- ▷ Do not continue driving if there is an obvious oil leak.
- ▷ Do not continue driving if the warning message appears even when the oil level is correct.
- ▷ Have the fault corrected.
Please contact a qualified specialist workshop. We recommend that you have an authorized Porsche dealer to do this work as they have trained workshop personnel and the necessary parts and tools.

G – Fuel Gauge

The fuel gauge displays the contents of the tank when the ignition is on.

For information on fuel quality and refill capacities:

- ▷ Please see the chapter “FILLING CAPACITIES” on page 329.

For information on fuel and refuelling:

- ▷ Please see the chapter “FUEL” on page 265.

If the vehicle’s inclination changes (e.g. uphill/downhill driving), minor deviations in the gauge may occur.

Fuel reserve warning

If less than approximately 4 US gallons (15 liters) of fuel remains in the tank or the range on remaining fuel falls below approx. 30 miles (50 km) when the ignition is switched on or the engine is running, the warning light on the multi-function display in the instrument panel lights up.

- ▷ Refuel at the next opportunity.



Caution!

A shortage of fuel may damage the emission control system.

- ▷ Never drive the tank dry.
 - ▷ If the warning lights have come on, do not take bends at high speed.
-

For information on the emission control system:

- ▷ Please see the chapter “EMISSION CONTROL SYSTEM” on page 262.

H – Digital Speedometer

The digital speedometer **H** is integrated in the tachometer on the instrument panel.

I – Upshift Prompt Indicator

The consumption-oriented shift indicator to the right of the digital speed display on the tachometer helps you to develop a fuel-saving driving style.

The upshift indicator lights up - prompting you to shift up to the next-higher gear - depending on the selected gear, engine speed and accelerator pedal position.

The upshift indicator is only active when “Sport” or “Sport Plus” mode is switched off.

On vehicles with PDK transmission, the upshift prompt is only available in manual selection mode.

- ▷ Change to the next-higher gear when the shift indicator lights up.

J – Odometer

The displays for the total mileage and individual trips are integrated in the speedometer on the instrument panel.

The upper display counts the total mileage, the lower display shows individual trips.

After exceeding 9,999 kilometers or 6,213 miles, the trip counter returns to 0.

K – Reset Button for Trip Counter Display/Brightness Setting for Instrument Lighting

Resetting trip counter display

- ▷ Press rotary switch **K** for approximately 1 second.
The trip counter display is reset to “0”.

Adjusting brightness of instrument lighting

For information on adjusting the brightness of the instrument lighting:

- ▷ Please see the chapter “INSTRUMENT LIGHTING” on page 95.

L – PDK Display for Selector-Lever Position/Engaged Gear

When the engine is running, the selector-lever position and engaged forward gear are indicated in gates **D** or **M**.

Warning messages

If the selector lever is between two positions

- Effects:
The corresponding selector-lever position in the instrument panel flashes **and** the warning “Gear selector not engaged” appears on the multi-function display.
Action required:
Operate the footbrake and engage the selector lever properly.

If there is a fault in the transmission

- Depending on priority, either the warning “Fault Transmission” will appear in yellow or red or the warning “Gearbox temperature too high” will appear on the multi-function display.

Yellow “Fault Transmission” warning

- Effects:
Restricted gearshift comfort,
reverse gear fails.
Action required:
Have the fault corrected immediately.
Please contact a qualified specialist workshop. We recommend that you have an authorized Porsche dealer to do this work as they have trained workshop personnel and the necessary parts and tools.

Red “Fault Transmission” warning

- Effect:
Vehicle can be driven only until it comes to a stop.
Action required:
It is not possible to continue driving.
Stop the vehicle immediately in a suitable place. Have the vehicle towed to a qualified specialist workshop.

Warning “Gearbox temperature too high”

- Effects:
“Warning jerks” can be felt when driving off and the engine power may be restricted.
Action required:
Do not hold the vehicle with the accelerator on a hill, for example. Hold the vehicle with the brake. Reduce engine load. Stop the vehicle in a suitable place if possible. Allow the engine to run in selector-lever position **P** or **N** until the warning disappears.
- ▷ Please see the chapter “REDUCED DRIVING PROGRAM” on page 199.
- ▷ Please see the chapter “PORSCHE DOPPELKUPPLUNG (PDK)” on page 193.

Battery/Alternator

Warning message

The warning message “Fault Generator” will appear on the multi-function display in the instrument panel if the vehicle electrical system voltage drops significantly.

- ▷ Stop at a safe place and switch the engine off.

For information on warning messages on the multi-function display:

- ▷ Please see the chapter “OVERVIEW OF WARNING MESSAGES” on page 152.

Possible causes

- Defect in the battery charging system
- Broken drive belt

Warning!

Risk of accidents and risk of engine damage. A broken drive belt means there is no power assistance to the steering (more effort is required to steer) and engine cooling fails.

- ▷ Do not continue driving.
- ▷ Have the fault corrected.
- ▷ Please contact a qualified specialist workshop. We recommend that you have an authorized Porsche dealer to do this work as they have trained workshop personnel and the necessary parts and tools.

Danger of steering assistance failing during a long journey in water if the drive belt slips.

- ▷ If steering assistance fails, more effort will be required to steer.
-

Check Engine (Emission Control)

Warning light

The emission control system detects malfunctions that could cause increased pollutant emissions or consequential damage etc. well in advance. Faults are indicated by the warning light on the instrument panel which then either lights up continuously or flashes.

The faults are recorded in the control unit's fault memory.

The warning light on the instrument panel lights up when the ignition is switched on as a lamp check and goes out approx. 1 second after the engine starts.

The warning light on the instrument panel flashes to indicate operating states (e.g. engine misfiring) which may cause damage to certain parts of the emission control system.

- ▷ In this case, immediately reduce the engine load by easing off the accelerator pedal.

In order to avoid consequential damage to the engine or the exhaust-gas cleaning system (e.g. catalytic converter):

- ▷ Please contact a qualified specialist workshop. We recommend that you have an authorized Porsche dealer to do this work as they have trained workshop personnel and the necessary parts and tools.

Caution!

Risk of damage. If the warning light on the instrument panel continues flashing even when you have eased off the accelerator pedal, the emission control system may overheat.

- ▷ Stop as soon as possible in a safe place. Make sure that combustible materials, such as dry grass or leaves, cannot come into contact with the hot exhaust system.
 - ▷ Switch off the engine.
 - ▷ Have the fault corrected.
-

Acoustic Signals

A speaker in the instrument panel generates acoustic signals.

If the speaker is faulty, a warning will appear and the speaker will no longer make an acoustic signal (i. e. sound).

- ▷ Please see the chapter "OVERVIEW OF WARNING MESSAGES" on page 152.

Operating the Multi-Function Display in the Instrument Panel

On the multi-function display, you can view information relating to the relevant vehicle equipment, operate the audio source (radio, CD, iPod, etc.), check the oil level, check the tire pressure, use the stopwatch or operate the navigation system.

You can also modify different vehicle settings in the Vehicle menu.

It is not possible to describe all details of the functions in this Owner's Manual. The examples clearly demonstrate the functional principle and clarify the menu structure.

Warning!

There is a risk of accident if you set or operate the multi-function display, radio, navigation system, telephone or other equipment while driving. Operating these devices while driving could distract you from traffic and cause you to lose control of the vehicle.

- ▷ Operate the equipment while driving only if the traffic situation allows you to do so safely.
- ▷ Carry out any complicated operating or setting procedures only when the vehicle is stationary.

S93-044



Multi-function display

Note on operation

The multi-function display is only active when the ignition is on.

Certain menus are only available when the vehicle has stopped e.g. the adjustment menu for tire pressure monitoring.



Operating principle on vehicles with multi-function steering wheel

The multi-function display is operated using the rotary knob **A**, the Back button **B** and the MFS button **C**, which can be assigned as required.

Selecting menu, function, setting option

- ▷ Turn rotary knob **A** upwards or downwards.

Confirming selection (Enter)

- ▷ Press rotary knob **A**.

Moving back one or several selection levels

- ▷ Press button **B** (Back button).

◆ Individual assignment of the MFS button

Porsche Communication Management (PCM) functions or multi-function display functions can be assigned to the MFS button in the multi-function display on the instrument panel. Audio source selection is preset by default.

For information on individual assignment of the MFS button:

- ▷ Please see the chapter “CHANGING BUTTON ASSIGNMENT ON MULTI-FUNCTION STEERING WHEEL” on page 151.

For information on Porsche Communication Management:

- ▷ Please refer to the separate PCM operating instructions.

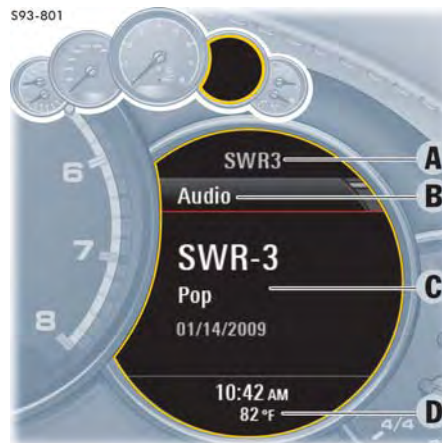

Operating principle on vehicles without multi-function steering wheel

The multi-function display is operated with the lower lever on the right of the steering column.

Selecting menu, function, setting option

- ▷ Push the lever downwards (position **3**) or upwards (position **4**).

Confirming selection (Enter)

- ▷ Push the lever forward (position **1**).

Moving back one or several selection levels

- ▷ Pull the lever towards the steering wheel (position **2**) once or several times.

A - Upper status area

B - Title area with menu indicator

C - Information area

D - Lower status area

Areas on the multi-function display

Upper status area/Lower status area

The upper **A** and lower status area **D** permanently display basic information, such as the current radio station, time and temperature or the remaining range.

The display contents of the upper and lower status area can be individually adapted.

For information on adapting the multi-function display:

- ▷ Please see the chapter “ADAPTING APPEARANCE OF MULTI-FUNCTION DISPLAY” on page 139.

Title area with menu indicator

The menu item currently selected is displayed in the title area.

The menu indicator on the right shows the position of the current menu item in the overall menu and displays the number of other menu items on this menu level.

The wider the menu indicator, the fewer menu items the current menu contains.

Information area

The information area **C** displays the menu items currently available for selection or after a menu item is selected, information relating to this menu item or other selection options.

Overview of menus in the multi-function display

The following main menu areas are available depending on the vehicle equipment.

- **“Vehicle”**
Retrieve vehicle information, check oil level, adjust settings, adapt speed limits, see page 119.
- **“Audio”**
Display/select radio station or track, see page 123.
- **“Navigation”**
Retrieve navigation information, enter navigation destination, start/finish navigation, see page 123.
- **“Map”**
Show/adapt the map display for navigation, see page 124.
- **“Phone”**
Make telephone calls, see page 125.
- **“Trip”**
Retrieve/reset trip information, see page 126.
- **“Tire pressure”**
Retrieve tire pressure information, modify Tire Pressure Monitoring settings, see page 127.
- **“Sport Chrono”**
Start/stop/reset stopwatch, see page 135.

- **“ACC”**
Retrieve adaptive cruise control information, see page 178.

Activating functions, opening submenus and accessing setting options from the main menu areas

Press the rotary knob **A** or push the right lower lever on the steering wheel forwards (position **1**) to access menus, other functions and setting options regardless of the main menu area.

1. Select main menu and confirm.
2. Select function, submenu or setting option and confirm.

Browsing through long lists

When searching for an entry in long telephone and audio lists on vehicles with PCM, you can skip directly to other entries with the same first letter.

- ▷ Briefly press the rotary knob **A** or hold the operating lever in position **3** or **4**.
A letter selection screen appears.

Select the desired first letters and confirm.
The marking skips to the first list entry beginning with the letters selected.

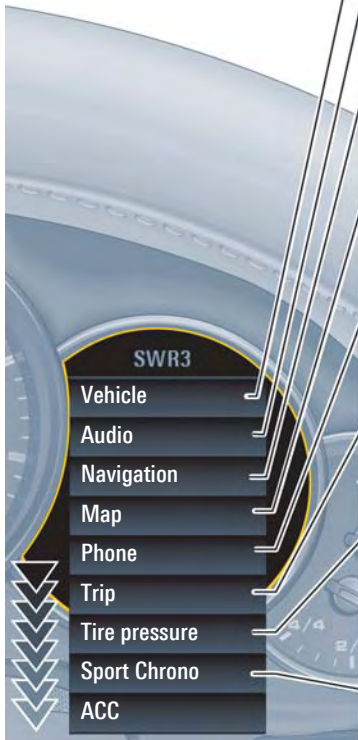

Info
Oil level
Settings
Limits

Station/track

Destination input
Start/Stop route guidance

Manual zoom
Show destination/position
Auto zoom
3D map
North up

Answer/Reject/End
Phonebook
Previous calls
Received calls

since
consecutive
to destination

Fill info
Tire info
Charge
Comfort press.
Adjust

Start
Stop
Round
Int

Messages
Service intervals
Level
∅ Consumption

Display

Light/visibility

Locking

Air conditioning

Date/Time

Units

Language

Volume

Steering wheel op.

Fact. settings

Limit 1/Limit 2

Last destination
Stored destinations
POIs

Res.
Reset

Menu scope
Audio
Vehicle menu
Upper line
PCM display
Lower line
Shift request
Brightness
Exterior lights
Interior lights
Wiper
Revers. opt.
Door unlock
Door lock
Comfort Entry
Climate style
Vent. panel
Center cooler
Automatic air circ.
Time
Date
Summer time
Time Chrono
Speedometer
Temperature
Tire pressure
Boost pressure
Consumption
German/French ...
ParkAssist
Warn. tones
Multif. key
Current speed
Setting the speed

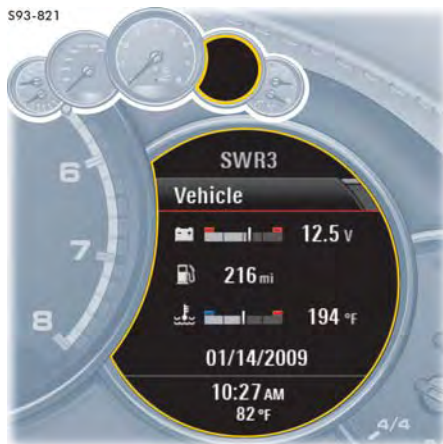

Vehicle information

Different items of vehicle information can be displayed on the multi-function display.

1. Select
> **"Vehicle"**

The vehicle information display can be adapted individually.

For information on adapting the vehicle menu:

- ▷ Please see the chapter "MULTI-FUNCTION DISPLAY CONFIGURATION EXAMPLE" on page 140.

Displaying vehicle information

Pending warning messages, information on forthcoming service intervals, the current chassis setting and the average fuel consumption can be viewed in the **"Info"** submenu of the **"Vehicle"** main menu area.

1. Select and confirm
> **"Vehicle"**
> **"Info"**

امداد خودرو فارما

تلفن شبانه روزی: ۰۲۱-۸۸۸۶۲۰۸۵

FarmaSOS.com



Displaying messages

All current warning messages and vehicle messages can be viewed on the multi-function display.

The warning symbol in the lower status area indicates the number of pending warning messages.

If several warning messages are pending, you can browse through the message list.

1. Select
> **"Vehicle"**
> **"Info"**
2. **"Messages"**
and confirm.

Displaying service intervals

The internal mileage counter indicates when the next vehicle service is due.

1. Select
> **"Vehicle"**
> **"Info"**
2. **"Service intervals"**
and confirm.
3. Select the desired service interval
and confirm.

Available service interval displays:

- **"Service"**
- **"Intermediate service"**
- **"Oil change"**

Displaying the selected chassis setting

You can view information on the current chassis setting.

1. Select
> **"Vehicle"**
> **"Info"**
2. **"Level"**
and confirm.

Displaying and resetting average fuel consumption

You can display and reset the average fuel consumption if required.

1. Select
> **"Vehicle"**
> **"Info"**
> **"∅ Consumption"**
and confirm.

Displaying average fuel consumption

1. Select
> **"Vehicle"**
> **"Info"**
> **"∅ Consumption"**
2. **"Consumption"**
and confirm.

Resetting average fuel consumption

1. Select
> **"Vehicle"**
> **"Info"**
> **"∅ Consumption"**
2. **"Reset"**
and confirm.

Note on operation

Resetting the average fuel consumption also resets the **"consecutive"** vehicle data display in the **"Trip"** menu.

For information on the driving data display:

- ▷ Please see the chapter "TRIP INFORMATION" on page 126.

Oil level

Display and measurement of the engine oil level



Caution!

Risk of engine damage.

- ▷ Regularly check the oil level each time before refuelling.
- ▷ Do not allow the oil level to fall below the minimum mark.

Prerequisites for the oil-level gauge:

- Ignition is switched on
or
Engine is running while the vehicle is stationary or in motion.
- After opening the hood, the oil level can only be measured after driving for at least 6 miles (10 km).

Activate the “Oil level” function on the multi-function display

1. Select

- > “**Vehicle**”
- > “**Oil level**”
and confirm.

- ▷ Please see the chapter “OVERVIEW OF WARNING MESSAGES” on page 152.



Measured oil level

The oil level reading is shown on the segment display in the oil level menu.

If the segments are filled in up to the top line, the oil level has reached the maximum mark.

- ▷ Under no circumstances add engine oil.



If the bottom segment is filled in, the oil level has reached the minimum mark.

The message “Check Minimum reached” appears on the multi-function display.

- ▷ Add engine oil immediately.



If the bottom segment is red, the oil level has dropped below the minimum mark.

The message “Oil level below minimum” appears on the multi-function display.

- ▷ Add engine oil immediately.

Top-up quantity

The difference between the minimum and maximum marks on the segment display is approx. 1 litre.

One segment of the display corresponds to a top-up quantity of approx. 0.26 US quarts (0.25 liters).

- ▷ Never add more engine oil than required to reach the maximum mark.



The maximum permitted engine filling capacity has been exceeded. Exceeding the maximum capacity may result in blue smoke formation and cause long-term damage to the catalytic converters depending on the overfill quantity and various external influences.

If too much engine oil was added, the message “Oil level Maximum reached” appears on the multi-function display.

- ▷ Have the oil quantity corrected at the next opportunity.
Please contact a qualified specialist workshop. We recommend that you have an authorized Porsche dealer to do this work as they have trained workshop personnel and the necessary parts and tools.

Measuring the oil level after topping up engine oil or opening the hood

After opening the hood, the oil level can only be measured after driving for at least 6 miles (10 km).

The message “Display after short drive only” appears on the multi-function display.

Failure

If the oil-level indicator fails, the message “Failure Oil level measurement” appears on the multi-function display.

امداد خودرو فارما

تلفن شبانه روزی: ۰۲۱-۸۸۶۲۰۸۵

FarmaSOS.com

Setting speed limits

If a speed limit is preset and activated on the multi-function display, a warning message appears if the speed limit is exceeded.

A speed limit can be used to remind the driver to keep to the maximum speed permitted for the tire type fitted to the vehicle, for example.

1. Select
> “**Vehicle**”
> “**Limits**”
and confirm.

Setting a speed limit

1. Select
> “**Vehicle**”
> “**Limits**”
2. “**Limit 1: ---**” or
“**Limit 2: ---**”
and confirm.
3. Select “**Current speed**” or
“**---**”
and confirm.

You can either adopt the current speed of the vehicle or specify your own speed limit.

Activating and deactivating speed limits

1. Select
> **“Vehicle”**
> **“Limits”**
2. **“Limit 1: ---”** or
“Limit 2: ---”
and confirm.
3. Select **“Active”**
4. Confirm selection.



Limit is active.

Limit is not active.

Adjusting vehicle settings

Various settings can be modified in the **“Vehicle”** submenu.

For information on modifying vehicle settings:

- ▷ Please see the chapter **“VEHICLE SETTINGS ON THE MULTI-FUNCTION DISPLAY”** on page 138.

1. Select
> **“Vehicle”**
> **“Settings”**
and confirm.

Selecting radio station or track

In the **“Audio”** main menu, you can select a radio station either from the station list or the list of stored stations, depending on the settings, or a track from the active audio source, e.g. disc.

1. Select
> **“Audio”**
and confirm.
2. Select the desired radio station or track and confirm.

For information on adjusting audio menu settings:

- ▷ Please see the chapter **“ADAPTING DISPLAY CONTENTS OF AUDIO MAIN MENU”** on page 139.

تلفن شبانه روزی: ۰۲۱-۸۸۶۲۰۸۵

FarmaSOS.com

Entering navigation destinations, starting route guidance and retrieving navigation information

In the **“Navigation”** main menu, you can enter a navigation destination, start route guidance and view the navigation information for an active route.

1. Select
> **“Navigation”**
and confirm.

Entering navigation destination

You can enter a navigation destination in the multi-function display.

Only navigation destinations from the list of previous destinations or from the list of preset POIs or stored destinations can be selected.

1. Select
> **“Navigation”**
> **“Destination input”**
2. **“Last destination”** or **“Stored destinations”** or **“POIs”**
and confirm.
3. Select desired navigation destination and confirm.

Starting route guidance

If route guidance is inactive and you have entered a new navigation destination you can then start route guidance.

1. Select > **“Navigation”**
2. **“Start route guidance”** and confirm.

Stopping route guidance

You can stop route guidance while in progress.

1. Select > **“Navigation”**
2. **“Stop route guidance”** and confirm.

Displaying and modifying the navigation map

In the **“Map”** main menu, you can view and modify the map display on the navigation system.

1. Select > **“Map”**

Modifying map display

1. Select > **“Map”** and confirm.
2. Select display option and confirm.
3. Confirm selection.



Function is active.

Function is not active. تلفن شبانه روزی

Available display options:

- **“Auto zoom”**
The scale of the map is set automatically from the current position of the vehicle to the next navigation maneuver point.
- **“3D map”**
Three-dimensional map display.
- **“North up”**
The map always faces north.

Enlarging and reducing map display

The zoom factor of the map display can be adapted individually.

1. Select > **“Map”** > **“Manual zoom”** and confirm.
2. Select the desired zoom setting and confirm.

Displaying current location or destination

You can view the navigation destination or current vehicle position on an enlarged section of the map.

1. Select > **“Map”**
2. **“Show destination”** or **“Show position”** and confirm.

Phone

In the **"Phone"** main menu, you can retrieve telephone numbers stored in the phonebook or in lists of most recently dialed or received calls.

1. Select
> **"Phone"**
and confirm.

Dialling telephone number

1. Select
> **"Phone"**
2. **"Phonebook"** or
"Previous calls" or
"Received calls"
and confirm.
3. Select the desired telephone number
and confirm.

Answering calls

1. Select
> **"Phone"**
2. Select **"Answer"**
and confirm.

Rejecting calls

1. Select
> **"Phone"**
2. **"Reject"**
and confirm.

Ending a call

1. Select
> **"Phone"**
2. **"End call"**
and confirm.

Making multiple calls simultaneously

During an active telephone conversation, you have the option of starting another telephone conversation.

You can have a separate conversation with the person you have called or alternatively start a conference call together with the other caller.

Making additional calls

During a current call:

1. Select
> **"Phone"**
2. **"New call"**
and confirm.

Switching between callers

1. Select
> **"Phone"**
2. **"Swap"**
and confirm.

Adding a caller to a conference call

1. Select
> **"Phone"**
2. **"Conference"**
and confirm.

FarmaSOS.com

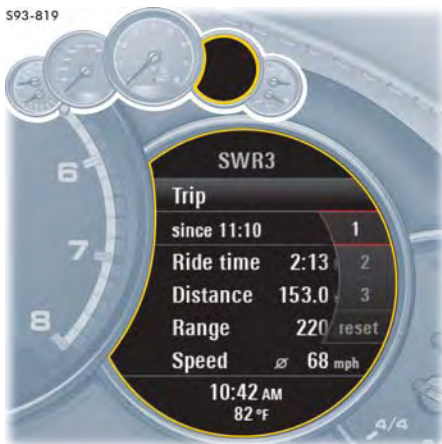

Trip information

In the **“Trip”** main menu, you can retrieve and reset driving data.

1. Select
> **“Trip”**

Displaying driving data

There are three driving data displays available.

1. Select
> **“Trip”**
2. **“1 – since”** or
“2 – consecutive” or
“3 – to destination”
and confirm.

Available driving data:

- **“since”**
Driving data since the last vehicle start.
The driving data is reset automatically once the vehicle has remained stationary for 2 hours (with the ignition key removed).
- **“consecutive”**
Cumulative driving data.
The driving data is added continuously until a reset is performed. The data is retained even if the ignition key is removed.
- **“to destination”**
Driving data up to navigation destination.
If route guidance is active, the driving data is calculated and displayed up to the navigation destination.

Resetting driving data

The selected driving data display can be reset.

1. Select
> **“Trip”**
2. Select the relevant driving data display and confirm.
3. Select **“Reset”**
and confirm

Tire Pressure Monitoring (TPM)

Each tire should be checked monthly when cold and inflated to the inflation pressure recommended by Porsche on the tire inflation pressure label.

For information on the tire inflation pressure label:

- ▷ Please see the chapter “TIRES AND WHEELS” on page 280.

As an added safety feature, your vehicle has been equipped with a tire pressure monitoring system (TPM) that illuminates a low tire pressure telltale (warning light) when one or more of your tires is significantly under-inflated.

Accordingly, when the low tire pressure telltale illuminates, you should stop and check your tires as soon as possible, and inflate them to the proper pressure. Driving on a significantly under-inflated tire causes the tire to overheat and can lead to tire failure. Under-inflation also reduces fuel efficiency and tire tread life, and may affect the vehicle's handling and stopping ability.

However, the tire pressure must still be set manually on the wheel.

- ▷ Please see the chapter “TIRE PRESSURE FOR COLD TIRES (68 °F/20 °C)” on page 326.

Danger!

Risk of serious personal injury or death. Driving the vehicle with low tire pressure increases the risk of a tire failure and resulting loss of control. Furthermore, low tire pressure increases rate of wear of the affected tires.

Please note that the Tire Pressure Monitoring is not a substitute for proper tire maintenance, and it is the driver's responsibility to maintain correct tire pressure, even if under-inflation has not reached the level to trigger illumination of Tire Pressure Monitoring low tire pressure telltale. Low tire pressure reduces the road safety of the vehicle and destroys the tire and wheel.

Tire Pressure Monitoring gives a warning about tire damage caused by a natural loss in pressure as well as about a gradual loss of pressure caused by foreign objects. Tire Pressure Monitoring cannot warn you about tire damage that occurs suddenly (e.g. flat tire due to abrupt external effects).

- ▷ When a red tire pressure warning appears, stop immediately in a suitable place and check the tires for damage. If necessary, remedy the damage with a tire sealant.
- ▷ Do not by any means continue to drive with defective tires.

- ▷ Sealing the tire with tire sealant is only an emergency repair so you can drive to the nearest specialist workshop. The permitted top speed is **50 mph (80 km/h)**.
- ▷ Do not drive with tires in which the tire pressure drops again very quickly. In case of doubt, have tires checked by a specialist workshop.
- ▷ Defective tires must be replaced immediately at an authorized Porsche dealer. **Tires must never be repaired under any circumstances.**
- ▷ If Tire Pressure Monitoring is defective (e.g. defective wheel transmitter), contact an authorized Porsche dealer immediately and have the damage repaired. The tire pressure will not be monitored at all or will be monitored only partially when Tire Pressure Monitoring is defective.

For information on warning messages on the multi-function display:

- ▷ Please see the chapter “OVERVIEW OF WARNING MESSAGES” on page 152.
- ▷ Incomplete entries or selection of the wrong tires on the multi-function display affect the accuracy of warnings and messages. The settings in the tire pressure menu must be updated following a wheel change or changes in vehicle loading.

- ▷ Use only the pressure differences shown in the “Fill info” display in the tire pressure menu or from the corresponding tire pressure warning when correcting the tire pressure.
 - ▷ Tires can lose air over time without a tire defect being present. A tire pressure warning will then appear on the multi-function display. Check the tire pressure at the next opportunity.
-

Warning light

Warning!

Your vehicle has also been equipped with a TPM malfunction indicator to indicate when the system is not operating properly.

The TPM malfunction indicator is combined with the low tire pressure telltale.

When the system detects a malfunction, the telltale will flash for approximately one minute and then remain continuously illuminated. This sequence will continue upon subsequent vehicle start-ups as long as the malfunction exists.

When the malfunction indicator is illuminated, the system may not be able to detect or signal low tire pressure as intended.

TPM malfunctions may occur for a variety of reasons, including the installation of replacement or alternate tires or wheels on the vehicle that prevent the TPM from functioning properly.

- ▷ Always check the TPM malfunction telltale after replacing one or more tires or wheels on your vehicle to ensure that the replacement or alternate tires and wheels allow the TPM to continue to function properly.
-

The warning light in the instrument panel lights up:

- When a loss in pressure has been detected.
- In the event of a defect in Tire Pressure Monitoring or a temporary fault.
- When learning new fitted wheels/wheel transmitters, as long as the vehicle's own wheels have not yet been recognized.

The tire pressure warning light on the instrument panel goes out only when the cause of the fault has been rectified.

Functional description of Tire Pressure Monitoring

Tire Pressure Monitoring offers the following functions:

- Display of the actual tire pressure while the vehicle is in motion.
- **“Fill info”** display:
Display of the deviation from the required pressure (refilling pressure) at standstill.
- **“Tire info”** display:
Display of current settings (when the vehicle is stationary).
- Tire pressure warnings in two stages (yellow and red warning).

Selecting the Tire pressure function on the multi-function display

1. Select
> **“Tire pressure”**
and confirm.

593-810



The **“Tire pressure”** function displays the temperature-dependent tire pressures (actual pressures) in the four wheels. You can watch the tire pressure rise as the temperature increases while driving. **This display is only for information.**

- > Under no circumstances should the tire pressures be changed based on this display.

593-818

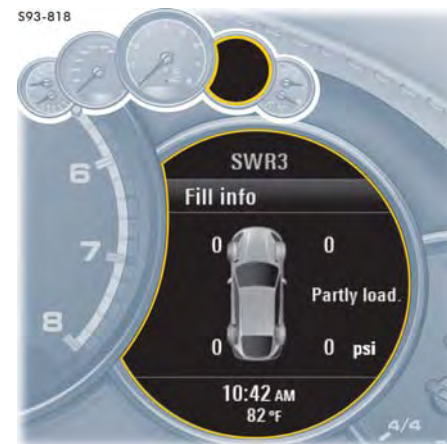

Viewing “Fill info” in the Tire pressure menu (only when vehicle is stationary)

1. Select
> **“Tire pressure”**
2. **“Fill info”**
and confirm.

You can read the tire pressures to be corrected on this display.

The tire pressure to be corrected (refill pressure) is indicated on the displayed wheel.

Example: If “-1.5 psi (-0.1 bar)” is displayed for the rear right tire, 1.5 psi (0.1 bar) must be added to this tire.

The displayed pressures take into account the tire temperature.

- ▷ Only use the pressure specifications from the “Fill info” display in the tire pressure menu or from the respective tire pressure warning to correct the tire pressure.

Note

Each time the ignition is switched on, it make take approx. 1 minute until all tire pressures are displayed. Dashes (-.-) appear instead of the tire pressures.

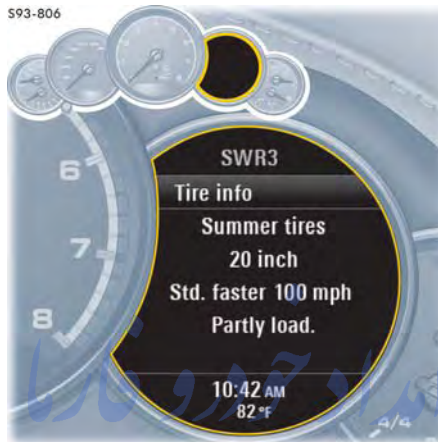

Viewing “Tire info” in the Tire pressure menu

1. Select > “Tire pressure”
2. “Tire info” and confirm.

The current settings are displayed.

Selecting “Charge” in the Tire pressure menu

1. Select > “Tire pressure”
2. “Charge” and confirm.
3. Select load type and confirm.

Available setting options:

- “Part load”
 - “Full load”
- ▷ Adapt the pressure of the tires to the selected load type.
See “Fill info” in the Tire pressure menu.

If this menu is not displayed, the specified tire pressures are valid for all types of vehicle load.



Selecting “Comfort pressure” in the Tire pressure menu

1. Select > “Tire pressure”
2. “Comfort press.” and confirm.
3. Select required pressure and confirm.

Available setting options:

- “Comfort”
- “Standard”

For speeds up to 100 mph (160 km/h), the tire pressures can be reduced to increase driving comfort.

The Tire Pressure Monitoring system must be set to the applicable tire pressure (comfort pressure or standard pressure).

If you selected “**Comfort press.**”, the TPM system automatically uses lower pressure values when monitoring tire pressures.

The comfort tire pressures are included in the technical data **or** under “**Fill info**” in the Tire pressure menu, you can compare the pressure differences (e.g. 4.4 psi (+0.3 bar)) with the “Comfort pressures”.

For tires that have not yet been learned, the new required tire pressures are displayed instead of the actual tire pressures.

For information on learning the tires:
 > Please see the chapter “SYSTEM LEARNING” on page 134.



Tires are inflated to comfort pressure at the factory, which is not suitable for driving at very high speeds.



Comfort pressure speed warning

If the maximum speed of the preset comfort pressure is exceeded, a warning message appears on the multi-function display.



Risk of accident when exceeding the maximum speed.

Driving at excessive speeds when the comfort pressure is active will destroy the tires.

- > Never exceed the speed specified on the warning message.
- > Always set the standard tire pressure when driving at higher speeds.

Selecting settings in the Tire pressure menu (type and size of fitted tire)

Warning!

Risk of accident due to excessive speed. This could lead to serious personal injury or death.

- ▷ Always observe the permissible maximum speed of the respective tire.
- ▷ Exceeding maximum tire speed could result in a tire burst, causing loss of control of the vehicle. This could lead to serious personal injury or death. Moreover, Porsche recommends obeying all traffic laws at all times to maintain the safety of yourself and all vehicle occupants.

Warning!

Incomplete entries or selection of the wrong tires on the multi-function display affect correct indication of warnings and messages.

- ▷ The settings must be updated in the **“Tire pressure”** menu after changing a wheel, filling with tire sealant or adding air (after previous warning **“Tire pressure!”**).
- ▷ Please see the chapter **“RED WARNING – TIRE PRESSURE!”** on page 133.

The new tire type and tire size must be selected even if the settings for the new set of wheels are the same as for the old wheels.

1. Select > **“Tire pressure”**
2. **“Adjust”** and confirm.
3. Select **“Summer tires”** or **“Winter tires”** or **“All-season”** and confirm.
4. Select the tire size and confirm.

Available setting options:

- **“18 inch”**
- **“19 inch”**
- **“20 inch”**

Tire selection has only been successfully completed when the following message appears on the multi-function display (example).

“Summer tires 19-inch was set. No monitoring, system is learning”.

- ▷ Please see the chapter **“SYSTEM LEARNING”** on page 134.

Notes

The message **“Action cancelled”** appears if the setting process is interrupted. All entries made up to this point are lost, and the original settings remain in effect.

Before fitting tires with dimensions that are not already stored in the multi-function display, the missing information should be added to the multi-function display.

- ▷ Please contact a qualified specialist workshop. We recommend that you have an authorized Porsche dealer to do this work as they have trained workshop personnel and the necessary parts and tools.

- ▷ Use only tires approved by Porsche.

The available items in the tire pressure menu depend on the model type. For this reason it is possible that some of the selection options shown here are not available on your multi-function display.

593-812



Yellow warning – Inflate!

Tire pressure warnings

The tire pressure warning light on the instrument panel and a corresponding message on the multi-function display warn about loss of pressure in two stages (yellow and red), depending on the amount of pressure loss.

Yellow warning – Inflate

The pressure in the tire is too low by more than **4 to 7 psi (0.3 to 0.5 bar)**. The tire pressure warning specifies the affected tire and the target tire pressure. Correct the tire pressure at the next opportunity.

This tire pressure warning appears:

- for approx. 10 seconds when the vehicle is stationary and the ignition is switched off **or**
- when the ignition is switched on again.

The warning can be acknowledged when the ignition is switched on.

The tire pressure warning light on the instrument panel goes out when the tire pressure has been corrected.

امداد خودرو فارما

تلفن شبانه روزی: ۰۲۱-۸۸۸۶۲۰۸۵

FarmaSOS.com

593-820



Red warning – Tire pressure!

Red warning – Tire pressure!

At speeds **below** 100 mph (160 km/h):

The pressure in the tire has dropped by **more than 7 psi (0.5 bar)**. This significant pressure loss is a danger to road safety.

At speeds **above** 100 mph (160 km/h):

The pressure in the tire has dropped by **more than 6 psi (0.4 bar)**. This significant pressure loss is a danger to road safety.

- ▷ When the tire pressure warning appears, stop immediately at a suitable location. Check the indicated tire for signs of damage.

If necessary, fill in tire sealant and set the correct tire pressure.

This tire pressure warning also appears when driving and can be acknowledged. The tire pressure warning light on the instrument panel goes out only when the tire pressure has been corrected.

System learning

Tire Pressure Monitoring begins to “learn” the wheels after a wheel change, wheel transmitter replacement or update of the tire settings. During this process, Tire Pressure Monitoring recognizes the wheels and their locations.

The following message appears on the multi-function display (example):

“No monitoring, system is learning”.

The wheel learning process takes place exclusively when the vehicle is being driven (vehicle speed above 16 mph (25 km/h)).

Tire Pressure Monitoring requires a certain amount of time to learn the wheels. During this time, the current tire pressures are not available on the multi-function display:

- The tire pressure warning light remains lit until all wheels have been learned.
- Lines (-.-) appear on the display of the “Tire pressure” function.

- The required pressures for cold tires (68 °F (20 °C)) are indicated under “Fill info” in the tire pressure menu.

Position and pressure information is displayed as soon as Tire Pressure Monitoring has assigned the wheels recognized as belonging to the vehicle to the correct wheel positions.

- ▷ Check the tire pressure for all wheels under “Fill info”.
- ▷ Correct the tire pressure to the required pressure if necessary.

Changing a wheel and replacing tires

- ▷ New wheels must be fitted with radio transmitters for Tire Pressure Monitoring. Before tires are changed, the battery charge condition of the wheel transmitters should be checked. Please contact a qualified specialist workshop. We recommend that you have an authorized trained workshop personnel and the necessary parts and tools.
 - ▷ Switch off the ignition when changing a wheel.
- The tire settings on the multi-function display must be updated after changing a wheel. If the tire settings are not updated, the message “Tire change? Update settings!” is displayed on the multi-function display.
- ▷ Update the multi-function display settings the next time the vehicle is stationary.

Pressure increase as the result of temperature increase

In accordance with physical principles, the tire pressure changes as the temperature changes. The tire pressure increases or decreases by 0.1 bar (1.5 psi) for every 18 °F (10 °C) change in temperature.

Partial monitoring

Monitoring of the other wheels is continued if there is a fault in one or two wheel transmitters.

- The tire pressure warning light lights up.
- The message “Restricted monitoring” appears on the multi-function display.
- No tire pressures are displayed on the multi-function display for wheels with faulty wheel transmitters.

No monitoring

In the event of faults, Tire Pressure Monitoring cannot monitor the tire pressure. The warning light on the instrument panel lights up and a corresponding message appears on the multi-function display.

Monitoring is not active:

- if Tire Pressure Monitoring is faulty,
 - if wheel transmitters for Tire Pressure Monitoring are missing,
 - during the learning phase after the tire settings have been updated,
 - after a wheel change without updating the tire settings,
 - if more than four wheel transmitters are recognized,
 - if there is external interference by other radio sources, e.g. wireless headphones,
 - if tire temperatures are too high.
- ▷ Please see the chapter “OVERVIEW OF WARNING MESSAGES” on page 152.



Sport Chrono/Stopwatch

You can use the stopwatch to measure any times, e.g. on race circuits or on work-related journeys. Measured lap times can be stored and evaluated if the vehicle is equipped with Porsche Communication Management (PCM).

- ▷ Please observe the chapter “SPORT DISPLAY” in the separate PCM operating instructions.

Stopwatch on the dashboard

The stopwatch has an analogue and a digital display.

The large pointer of the analogue display measures the seconds. The two small pointers measure hours and minutes. The display restarts at zero after 12 hours.

Seconds and increments of 1/10 and 1/100 of a second can be read on the digital display. The digital display and the display on the on-board computer can indicate up to 99 hours and 59 minutes.

Stopwatch timing displays

The stopwatch time is displayed at different positions on the dashboard:

- In the stopwatch on the dashboard.
- In the “**Chrono**” menu in the multi-function display on the instrument panel.
- In the “CAR” main menu on the PCM.

Displaying the time on the stopwatch

You can configure the stopwatch on the dashboard to display the time in the multi-function display on the instrument panel.

For information on displaying the time on the stopwatch:

- ▷ Please see the chapter “DISPLAYING TIME IN STOPWATCH ON DASHBOARD” on page 148.

Sport Chrono on multi-function display

All stopwatch displays are started and stopped in the "Chrono" menu on the multi-function display.

For instructions on using the multi-function display:

- ▷ Please see the chapter "OPERATING THE MULTI-FUNCTION DISPLAY IN THE INSTRUMENT PANEL" on page 115.

1. Select > **"Chrono"** and confirm.

Notes on operation

If you exit the **"Chrono"** menu while the stopwatch is running, measurement will continue.

The stopwatch stops after the ignition is switched off. If the ignition is switched on again within approximately 4 minutes, the stopwatch will continue to run.

The only way to reset the stopwatch to zero is by selecting **"Reset"** in the **"Chrono"** menu.

For information on resetting the stopwatch:

- ▷ Please see the chapter "RESETTING THE STOPWATCH TIME" on page 137.



- A - Current stopwatch time
- B - Reference time (fastest lap)
- C - Number of completed laps
- D - Circle display: Compares the current lap time with the reference time

Starting timing

1. Select > **"Chrono"**
2. **"Start"** and confirm.

The stopwatch time **A** is displayed simultaneously on all stopwatch displays in the vehicle.

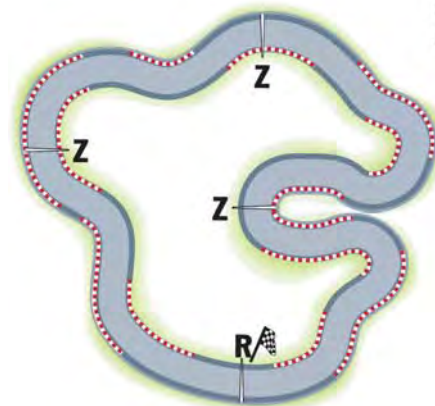

- R - Lap time (stored)
- Z - Intermediate time (not stored)

Stopping lap/Starting new lap

The current stopwatch time can be stored as a lap time while the stopwatch is still running.

1. Select > **"Chrono"**
2. **"Round"** and confirm.

The lap counter value **C** increases by one.
The time of the fastest completed lap is stored temporarily as a reference value **B**.
The stopwatch time **A** and the circle display **D** turn a different color to indicate whether the current lap time is quicker than, slower than or identical to the current fastest lap.

- Green: Current lap time is faster.
- Yellow: Current lap time is identical.
- Red: Current lap time is slower.

Note

If a reference time has not been stored yet, the reference time position **B** remains blank.
The segment display is not colored.

A maximum of 63 laps can be stored during each session.

Storing intermediate time

You can store an intermediate time while the stopwatch is still running.

1. Select
> **"Chrono"**
2. Select **"Int"**
and confirm.

The intermediate time is displayed temporarily on the multi-function display.
Timing continues in the background.

Stopping timing

You can stop the stopwatch at any time.

1. Select
> **"Chrono"**
2. **"Stop"**
and confirm.

The stopwatch time **A** stops.

Continuing timing

You can resume timing again after stopping the stopwatch.

1. Select
> **"Chrono"**
> **"Stop"**
2. **"Res."**
and confirm.

The stopwatch time **A** continues.

امداد خودرو پارسی
تلفن شبانه روزی: ۰۲۱-۸۸۸۶۲۰۸۵
FarmaSOS.com

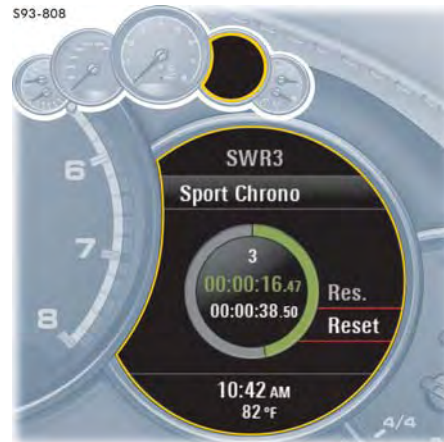

Resetting the stopwatch time

The stopwatch time can be reset to zero.

1. Select
> **"Chrono"**
> **"Stop"**
2. **"Reset"**
and confirm.

All stopwatch time displays are reset to zero.

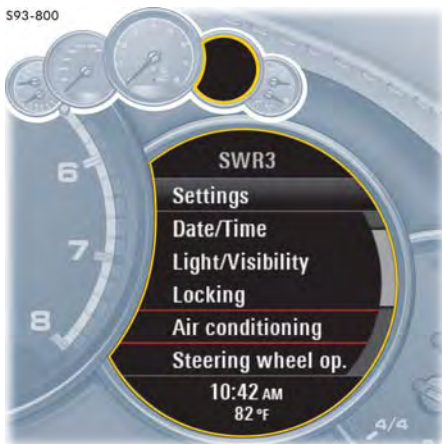

Vehicle Settings on the Multi-Function Display

Different settings can be adjusted in the multi-function display on the instrument panel depending on the vehicle equipment.

On vehicles with comfort memory, the settings are stored on the car key or the person buttons in the driver's door.

For information on the comfort memory:

- ▷ Please see the chapter "COMFORT MEMORY" on page 40.

Selecting settings menu

1. Select
 - > "Vehicle"
 - > "Settings"
 - and confirm.

Setting options

The following vehicle functions can be adapted individually:

- "Display"
Adapt the appearance of the multi-function display, see page 139.
- "Light/Visibility"
Adjust the vehicle lighting, wipers and reversing options, see page 142.
- "Locking"
Adjust the locking settings, see page 145.
- "Air conditioning"
Adapt the air conditioning, see page 146.
- "Date/time"
Set the date and time, see page 147.
- "Units"
Set the units of measurement on the instruments and display, see page 149.
- "Language"
Set the language of the multi-function display and the instrument panel, see page 150.

- "Volume"
Adjust the volume of the warning and information tones, see page 150.
- "Steering wheel operation"
Change the MFS button assignment on the multi-function steering wheel, see page 151.
- "Reset"
Reset to factory settings, see page 139.

Selecting setting options or activating vehicle functions

A symbol positioned in front of a setting option indicates whether the option is selected or a vehicle function is activated.

Selecting one of several options



Option is selected.



Option is not selected.

Activating and deactivating functions



Function is activated.



Function is deactivated.

Resetting to factory settings

All settings made in the multi-function display can be reset to the factory settings:

Note

All personal settings that have already been stored will be lost as a result of resetting to factory settings.

1. Select
> **“Vehicle”**
> **“Settings”**
2. **“Fact. settings”**
and confirm.
3. Select **“Yes”**
and confirm.

Adapting appearance of multi-function display

The contents and appearance of the multi-function display can be adapted individually.

1. Select
> **“Vehicle”**
> **“Settings”**
> **“Display”**
and confirm.

Selecting main menu display contents

Individual elements in the main menu can be hidden and shown as required.

The main menu items **“Audio”**, **“Navigation”**, **“Map”**, **“Phone”**, **“Trip”**, **“Tire pressure”** and **“Sport Chrono”** can be hidden or shown. The **“Settings”** menu item cannot be hidden.

1. Select
> **“Vehicle”**
> **“Settings”**
> **“Display”**

2. **“Menu scope”**
and confirm.
3. Select the desired main menu items.
4. Confirm selection.



Menu item is displayed.

Menu item is hidden.

Adapting display contents of audio main menu

In the audio main menu, you can display either a list of all radio stations currently within range or a list of all stored radio stations.

1. Select
> **“Vehicle”**
> **“Settings”**
> **“Display”**

2. **“Audio”**
and confirm.
3. Select the desired display contents
and confirm.

Available display contents:

- **“Station list”**
List of stations currently within range.
- **“Preset list”**
List of stored stations.

For information on the station and preset lists:

- ▷ Please observe the separate operating manual for the Porsche communication Management (PCM).

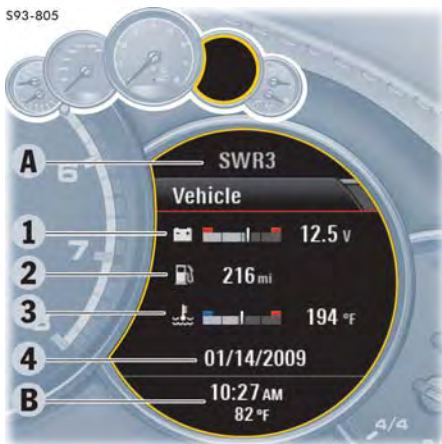

Multi-function display configuration example

Adapting display contents in vehicle information area

You can select four of the many items of vehicle information for display in the **“Vehicle”** menu and assignment to the display areas **1**, **2**, **3** and **4**.

1. Select
 - > **“Vehicle”**
 - > **“Settings”**
 - > **“Display”**

2. **“Vehicle menu”** and confirm.
3. Select **“1:”** or **“2:”** or **“3:”** or **“4:”** and confirm.
4. Select the desired display contents and confirm.

Available display contents:

“Coolant temp.” (coolant temperature), **“Compass”**, **“Oil temperature”**, **“Oil pressure”**, **“Boost pressure”**, **“Rem. fuel rng.”**, **“Station/Track”** (current radio station/music title), **“Veh. voltage”**, **“Int: Trip time”** (driving time to intermediate destination), **“Int: Arrival”** (arrival time at intermediate destination), **“Dst: Trip time”** (driving time to destination), **“Destination arrival”** (arrival time at destination), **“Date”**, **“Phone info”** (network strength/network name), **“Blank line”** (area remains blank).

One item of information cannot be assigned to several areas or one area **and** the **“Upper line”**.

Adapting upper status area

You can assign various items of information to the upper status area **A** in the multi-function display.

1. Select
 - > **“Vehicle”**
 - > **“Settings”**
 - > **“Display”**

2. **“Upper line”** and confirm.
3. Select the desired display contents and confirm.

Available display contents:

- **“Station name”**
- **“Rem. fuel rng.”**
- **“Compass”**
- **“Boost pressure”**
- **“Blank line”**

No information appears in the upper status area **A**.

Displaying PCM information on the multi-function display

You can configure the multi-function display to temporarily display different items of information relating to Porsche Communication Management (PCM).

1. Select
 - > **“Vehicle”**
 - > **“Settings”**
 - > **“Display”**
2. **“PCM display”**
and confirm.
3. Select desired PCM information.
4. Confirm selection.



Information is displayed.

Information is not displayed.

Available PCM information:

- **“Map info”**
Navigation map appears automatically when navigation information is available.
- **“Phone info”**
Information on incoming and outgoing calls is displayed.
- **“Voice control”**
Help text appears when the voice control button is pressed.

- **“Arrow info”**
Navigation arrow appears automatically when navigation information is available.
- **“Speed limit”**
Speed limits marked on the map in the navigation system are displayed.

Adapting lower status area

You can assign the current time and outside temperature to the lower status area **B** in the multi-function display.

1. Select
 - > **“Vehicle”**
 - > **“Settings”**
 - > **“Display”**
2. **“Lower line”**
and confirm.
3. Select the desired display contents
and confirm.

Available display contents:

- **“Time”**
- **“Temperature”**
- **“Date & temp.”**

Hiding and showing upshift prompt indicator

You have the option of displaying an upshift prompt indicator in the digital speedometer inside the tachometer to indicate the ideal gear-changing points when changing gear manually with the Porsche Doppelkupplung (PDK) transmission or on vehicles with a manual transmission, and encourage a more fuel-efficient driving style.

1. Select
 - > **“Vehicle”**
 - > **“Settings”**
 - > **“Display”**
2. **“Shift request”**
3. Confirm selection.



Upshift prompt is displayed.

Upshift prompt is hidden.

Adjusting display brightness

The brightness of the multi-function display can be adjusted to suit individual requirements.

1. Select
 - > **“Vehicle”**
 - > **“Settings”**
 - > **“Display”**
2. **“Brightness”**
and confirm.
3. Adjust to the desired display brightness
and confirm.

Light and visibility settings

The exterior lights, interior lighting and visual aids for reversing the vehicle can be adapted individually.

1. Select
 - > **"Vehicle"**
 - > **"Settings"**
 - > **"Light/Visibility"**and confirm.

Adjusting exterior lights

You can adapt the exterior light functions on the vehicle e.g. daytime driving light mode and off delays of the Welcome Home and Entry functions in the **"Exterior lights"** menu.

1. Select
 - > **"Vehicle"**
 - > **"Settings"**
 - > **"Light/Visibility"**
 - > **"Exterior lights"**and confirm.

Activating and deactivating automatic daytime driving lights

The daytime driving lights can be switched on and off (not available in Canada).

1. Select
 - > **"Vehicle"**
 - > **"Settings"**
 - > **"Light/Visibility"**
 - > **"Exterior lights"**

2. "Daytime light"

3. Confirm selection.



Daytime driving lights are activated.

Daytime driving lights are deactivated.

تلفن شبانه روزی: ۰۲۱-۸۸۶۲۰۸۵

FarmaSOS.com

Adjusting off delay for Welcome Home and Entry functions

The off delay of the Welcome Home and Entry functions can be adapted individually.

1. Select
 - > **"Vehicle"**
 - > **"Settings"**
 - > **"Light/Visibility"**
 - > **"Exterior lights"**

2. "Fade-out"

and confirm.

3. Set desired off delay and confirm.

Adjusting interior lights

Interior light functions on the vehicle can be adapted individually in the **"Interior lights"** menu.

1. Select
 - > **"Vehicle"**
 - > **"Settings"**
 - > **"Light/Visibility"**
 - > **"Interior lights"**and confirm.

Adjusting brightness of orientation lighting

The brightness of the orientation lighting can be adapted individually.

1. Select
 - > **"Vehicle"**
 - > **"Settings"**
 - > **"Light/Visibility"**
 - > **"Interior lights"**
2. **"Amb. light"**
and confirm.
3. Adjust to the desired brightness
and confirm.

Setting interior lighting off delay

The off delay for the lighting in the passenger compartment after closing the vehicle doors can be adapted individually.

1. Select
 - > **"Vehicle"**
 - > **"Settings"**
 - > **"Light/Visibility"**
 - > **"Interior lights"**
2. **"Fade-out"**
and confirm.
3. Set desired off delay
and confirm.

Setting wiper operation

You have the option of adjusting the activation mode of the rain sensor and the rear wiper.

1. Select
 - > **"Vehicle"**
 - > **"Settings"**
 - > **"Light/Visibility"**
 - > **"Wiper"**and confirm.

Setting rain sensor activation

Activation of the rain sensor for the windshield wipers on the windshield in wiper stalk position **1** can be adjusted.

For information on the front wipers:

- ▷ Please see the chapter "FRONT WIPER AND HEADLIGHT WASHER SYSTEM" on page 102.

1. Select
 - > **"Vehicle"**
 - > **"Settings"**
 - > **"Light/Visibility"**
 - > **"Wiper"**
2. **"Rain sensor"**
and confirm.
3. Select desired setting
and confirm.

Available setting options:

- **"Automatic"**
The rain sensor is activated automatically if the wiper stalk is in position **1** when the ignition is switched on.
- **"Manual"**
The rain sensor remains deactivated if the wiper stalk is in position **1** when the ignition is switched on.

Setting activation of the rear wiper when reverse gear is engaged

You can configure the rear wiper to automatically perform a series of wipes when it is raining when reverse gear is engaged.

1. Select
 - > **"Vehicle"**
 - > **"Settings"**
 - > **"Light/Visibility"**
 - > **"Wiper"**
2. **"Rear wiper"**
and confirm.
3. Select desired setting
and confirm.

Available setting options:

- **“Automatic”**
The rear wiper performs a series of wipes when reverse gear is engaged.
- **“Manual”**
The rear wiper is not activated when reverse gear is engaged.

Adjusting reversing options

You can configure the exterior mirrors and the rear roll-up blind to lower automatically when reverse gear is engaged.

1. Select
 - > **“Vehicle”**
 - > **“Settings”**
 - > **“Light/Visibility”**
 - > **“Revers. opt.”**and confirm.

Lowering exterior mirror on passenger’s side when parking

You can configure the exterior mirror on the passenger’s side to tilt downwards automatically when reverse gear is engaged to provide a better view of the curb.

1. Select
 - > **“Vehicle”**
 - > **“Settings”**
 - > **“Light/Visibility”**
 - > **“Revers. opt.”**and confirm.

2. Select **“Lowering mirr.”**.

3. Confirm selection.



Exterior mirror is lowered.



Exterior mirror is not lowered.

تلفن شبانه روزی: ۰۲۱-۸۸۸۶۲۰۸۵

FarmaSOS.com

Lowering rear roll-up blind when parking

You can configure the rear roll-up blind to lower automatically when reverse gear is engaged.

1. Select
 - > **“Vehicle”**
 - > **“Settings”**
 - > **“Light/Visibility”**
 - > **“Revers. opt.”**and confirm.

2. Select **“Blind opening”**.

3. Confirm selection.



Rear roll-up blind is lowered.



Rear roll-up blind is not lowered.

Locking settings

The locking and unlocking settings on the vehicle can be adjusted.
The Easy Entry function can be switched on and off.

1. Select
 - > **"Vehicle"**
 - > **"Settings"**
 - > **"Locking"**and confirm.

Setting door unlocking

You can configure specific doors to unlock when the vehicle is unlocked.

1. Select
 - > **"Vehicle"**
 - > **"Settings"**
 - > **"Locking"**
2. **"Door unlock"**
and confirm.
3. Select desired setting
and confirm.

Available setting options:

- **"All doors"**
All doors and the tailgate are unlocked when the vehicle is unlocked.
- **"Driver's door"**
The driver's door and the tailgate are unlocked when the vehicle is unlocked.

Setting door locking

You can configure the doors to remain unlocked or lock automatically after a delay on entering the vehicle.

1. Select
 - > **"Vehicle"**
 - > **"Settings"**
 - > **"Locking"**
2. **"Door lock"**
and confirm.
3. Select desired setting
and confirm.

Available setting options:

- **"Off"**
The doors are not locked automatically after entering the vehicle.
- **"After ign. on"**
The doors are locked automatically when the ignition is switched on.
- **"After drive-off"**
The doors are locked automatically after driving off.

Switching Comfort Entry on and off

You can configure the driver's seat and steering wheel to move back automatically and allow the driver to get in and out of the vehicle more easily.

1. Select
 - > **"Vehicle"**
 - > **"Settings"**
 - > **"Locking"**
2. Select **"Comfort Entry"**.
3. Confirm selection.



Comfort Entry is activated.

Comfort Entry is deactivated.

Setting air conditioning

The automatic air conditioning can be changed individually.

1. Select
 - > **“Vehicle”**
 - > **“Settings”**
 - > **“Air conditioning”**and confirm.

Adjusting air flow

The strength of the air flow and the air quantity can be adjusted.

1. Select
 - > **“Vehicle”**
 - > **“Settings”**
 - > **“Air conditioning”**

2. **“Climate style”**
and confirm.
3. Select desired setting
and confirm.

Available setting options:

- **“Soft”**
- **“Normal”**
- **“Strong”**

Switching extended ventilation panel on and off

The extended ventilation panel on top of the dashboard can be switched on or off.

1. Select
 - > **“Vehicle”**
 - > **“Settings”**
 - > **“Air conditioning”**

2. **“Vent. panel”.**
3. Confirm selection.



Ventilation panel is activated.



Ventilation panel is deactivated.

Setting central vents to blow colder air

The temperature of the air blown from the central vents can be decreased. The preset interior temperature remains the same. *تلفن شبانه روزی: ۰۲۱-۸۸۸۸۸۸۸۸*

1. Select
 - > **“Vehicle”**
 - > **“Settings”**
 - > **“Air conditioning”**

2. **“Center cooler”.**
3. Confirm selection.



Function is activated.



Function is deactivated.

Switching automatic air-recirculation mode on/off

You can configure the fresh air supply to adjust automatically to the air quality.

1. Select
 - > **“Vehicle”**
 - > **“Settings”**
 - > **“Air conditioning”**

2. **“Automatic air circ.”**
3. Confirm selection.



Automatic air-recirculation mode is activated.



Automatic air-recirculation mode is deactivated.

Setting date and time

The date and time displays on the vehicle can be adjusted individually.

Note

On vehicles with Porsche Communication Management (PCM), the date and time are set automatically by satellite navigation signals (GPS). Some setting options may be temporarily unavailable, depending on satellite signal reception.

1. Select
 - > **“Vehicle”**
 - > **“Settings”**
 - > **“Date/Time”**and confirm.

Setting the time

The time, time format and time zone can be set in the **“Time”** menu.

1. Select
 - > **“Vehicle”**
 - > **“Settings”**
 - > **“Date/Time”**
 - > **“Time”**and confirm.

Setting the time format

The time can be displayed in 12-hour or 24-hour format.

1. Select
 - > **“Vehicle”**
 - > **“Settings”**
 - > **“Date/Time”**
 - > **“Time”**
2. **“Format”**
and confirm.
3. Select desired setting
and confirm.

Available setting options:

- **“12h”**
- **“24h”**

تلفن شبانه روزی: ۰۲۱-۸۸۶۲۰۸۵

FarmaSOS.com

Setting current time

The hours and minutes can be set individually.

1. Select
 - > **“Vehicle”**
 - > **“Settings”**
 - > **“Date/Time”**
 - > **“Time”**and confirm.
2. Select **“Hour/Minute”**.
3. Set desired time
and confirm.

Setting time zone

The time zone and vehicle time can be adjusted individually.

1. Select
 - > **“Vehicle”**
 - > **“Settings”**
 - > **“Date/Time”**
 - > **“Time”**
2. Select **“Zone”**
and confirm.
3. Set desired time zone
and confirm.

Setting the date

The date and date format can be changed in the “Date” menu.

1. Select
 - > “Vehicle”
 - > “Settings”
 - > “Date/Time”
 - > “Date”and confirm.

Setting the date format

The date format can be adjusted.

1. Select
 - > “Vehicle”
 - > “Settings”
 - > “Date/Time”
 - > “Date”
2. “Format”
and confirm.
3. Select desired setting
and confirm.

Available setting options:

- “DD.MM.YYYY”
- “MM/DD/YYYY”
- “YYYY/MM/DD”

Setting the current date

The day, month and year can be set individually.

1. Select
 - > “Vehicle”
 - > “Settings”
 - > “Date/Time”
 - > “Date”and confirm.
2. Select “Date”.
3. Set the desired date
and confirm the setting.

Setting summer time

The vehicle clock can be configured to change to summer time.

1. Select
 - > “Vehicle”
 - > “Settings”
 - > “Date/Time”
2. Select “Summer time”.
3. Confirm selection.

- Summer time is activated.
- Summer time is deactivated.

Displaying time in stopwatch on dashboard

You can configure the stopwatch on the dashboard to display the time.

1. Select
 - > “Vehicle”
 - > “Settings”
 - > “Date/Time”
2. Select “Time - Chrono”.
3. Confirm selection.

- Time is displayed.
- Time is not displayed.

Setting units

You can select the units of measurement for vehicle displays such as the speed on the digital speedometer in the instrument panel, the temperature gauge in the air-conditioning displays and the tire pressure display on the multi-function display.

1. Select
> **“Vehicle”**
> **“Settings”**
> **“Units”**
and confirm.

Setting speedometer units

The units of the speed and distance information on the speedometer can be adjusted.

1. Select
> **“Vehicle”**
> **“Settings”**
> **“Units”**
2. Select **“Speedometer”**.
3. Select desired setting and confirm.

Available setting options:

- **“km/km/h”**
- **“Miles/mph”**

Setting unit for temperature gauges

The measurement unit for temperature gauges can be changed.

1. Select
> **“Vehicle”**
> **“Settings”**
> **“Units”**
2. **“Temperature”**.
3. Select desired setting and confirm.

Available setting options:

- **“°C”**
- **“°F”**

Setting unit for Tire Pressure Monitoring display

The measurement unit for the Tire Pressure Monitoring display can be changed.

1. Select
> **“Vehicle”**
> **“Settings”**
> **“Units”**
2. **“Tire pressure”**.
3. Select desired setting and confirm.

Available setting options:

- **“bar”**
- **“psi”**

Setting unit for boost-pressure gauge

The measurement unit for the boost-pressure gauge can be changed.

1. Select
> **“Vehicle”**
> **“Settings”**
> **“Units”**
2. **“Boost pressure”**.
3. Select desired setting and confirm.

Available setting options:

- **“bar”**
- **“psi”**

Setting unit for fuel consumption display

The unit can be set for the fuel consumption display.

1. Select
 - > **"Vehicle"**
 - > **"Settings"**
 - > **"Units"**
2. **"Consumption"**.
3. Select desired setting and confirm.

Available setting options:

- "l/100 km"
- "MPG (US)"
- "MPG (UK)"
- "km/l"

Changing the language

The language of the display text on the multi-function display can be changed.

1. Select
 - > **"Vehicle"**
 - > **"Settings"**
 - > **"Language"**
2. Select desired language and confirm.

Adjusting volume of warning and information tones

The volume of the warning tones and ParkAssist information tones can be adjusted.

1. Select
 - > **"Vehicle"**
 - > **"Settings"**
 - > **"Volume"**and confirm.

Adjusting ParkAssist volume

The volume of the ParkAssist information tones can be adjusted.

1. Select
 - > **"Vehicle"**
 - > **"Settings"**
 - > **"Volume"**
2. **"ParkAssist"**.
3. Select desired setting and confirm.

Available setting options:

- "Loud"
- "Medium"
- "Low"

Adjusting volume of warning tones

The volume of the warning tones can be adjusted individually.

1. Select
 - > **“Vehicle”**
 - > **“Settings”**
 - > **“Volume”**
2. **“Warn. tones”**.
3. Select desired setting and confirm.

Available setting options:

- **“Loud”**
- **“Medium”**
- **“Low”**

Changing button assignment on multi-function steering wheel

The assignment of the MFS button on the multi-function display can be changed individually. Functions from the multi-function display or PCM can be assigned to the MFS button.

1. Select
 - > **“Vehicle”**
 - > **“Settings”**
 - > **“Steering wheel op.”**
2. **“Multif. key”** and confirm.
3. Select **“PCM function”** or **“Inst. clus. fun.”** and confirm.
4. Select desired function assignment and confirm.

Available PCM functions:

- **“Source change”**
Change audio source.
- **“Voice control”**
Activate voice control.
- **“Dri. instr. (Rep)”**
Repeat voice instruction from the navigation system.
- **“Station/track <”**
Previous radio station/title.
- **“Station/track >”**
Next radio station/track.

- **“Map”**
Display navigation map in PCM.
- **“Menu change”**
Change main menu area.

Available instrument cluster functions:

- **“Start/Stop Chr.”**
Start/stop timing.
- **“Vehicle menu”**
Display vehicle menu.
- **“Trip menu”**
Display trip menu.
- **“TPM menu”**
Display TPM menu.
- **“Chrono menu”**
Display chrono menu.
- **“ACC menu”**
Display ACC menu.
- **“Audio menu”**
Display audio menu.
- **“Phone menu”**
Display telephone menu.
- **“Navi menu”**
Display navigation menu.
- **“Map menu”**
Display navigation map on the multi-function display.

Overview of Warning Messages

If a warning message appears, always refer to the corresponding sections in this Owner's Manual.

Warning messages are issued only if all measurement prerequisites are met.

Therefore, check all fluid levels regularly – in particular, always check the engine oil level before refuelling.

Warning message categories

Red warning: System failure warning





- ▷ Visit or consult a qualified specialist workshop immediately*.















Yellow warning: Fault or system failure warning











- ▷ Visit a qualified specialist workshop at the next opportunity*.















Yellow warning: Information message















- ▷ Visit a qualified specialist workshop at the next opportunity* or remedy yourself.

















Light in instrument panel	Warning message on multi-function display	Meaning/Action required
	Oil press. too low	Stop immediately in a suitable place and switch engine off. Do not continue driving. Select "Oil level" on the multi-function display. Add engine oil if necessary. Do not continue driving if the warning light comes on even when the oil level is correct. Have the fault corrected at a qualified specialist workshop.*
	Fault Oil pressure monitoring	Have the fault corrected at a qualified specialist workshop.*
	Oil temperature too high	Switch off engine and allow to cool. Check oil level and, if necessary, add oil.
	Oil temperature display defective	Have the fault corrected at a qualified specialist workshop.*











Light in instrument panel	Warning message on multi-function display	Meaning/Action required
	Failure Oil level measurement	Have the fault corrected at a qualified specialist workshop.*
	Minimum oil level reached	Top up engine oil immediately.
	Oil level below minimum	Top up engine oil immediately.
	Oil level Maximum reached	Visit a qualified specialist workshop at the next opportunity and have the oil drained to the correct level.*
Warning light on the coolant temperature gauge lights up	 Engine temperature too high	Coolant or engine oil temperature is too high. Switch off engine and allow to cool. Check coolant or engine oil level. Add more coolant or engine oil if necessary.
Warning light on the coolant temperature gauge flashes	 Check coolant level	Switch off engine and allow to cool. Check coolant level. Add coolant if necessary.
Warning light on the coolant temperature gauge flashes	 Coolant display defective	Have the fault corrected at a qualified specialist workshop.*
	 Fault Generator	Stop in a suitable place and switch engine off. Do not continue driving. Have the fault corrected at a qualified specialist workshop.*
	 Boost pressure display defective	Have the fault corrected at a qualified specialist workshop.*
	 Reduced engine power	Consult a qualified specialist workshop.*
	 Fault Check Engine	Have the fault corrected at a qualified specialist workshop.*
	 Fault Check Engine	Have the fault corrected at a qualified specialist workshop.*













Light in instrument panel	Warning message on multi-function display	Meaning/Action required
	Battery protection Consumer switch-off	The power supply to various comfort features is deactivated to prevent the battery from discharging.
	Start engine manually	Start engine manually at the ignition.
	Start/stop operation deactivated	Have the fault corrected at a qualified specialist workshop.*
Display of selector-lever position flashes	 Gearshift not engaged	PDK transmission: Selector lever may be positioned between two settings. Properly engage selector lever.
	 Move gear lever to position P.	PDK transmission: Move selector lever to position P before removing key from ignition lock.
	 Move gear lever to position P.	To stop and secure the vehicle, move the selector lever to position P.
	 Move gear lever to position P or N.	PDK transmission: Engine can only be started in selector-lever position P or N.
	 Press brake	PDK transmission: Apply the brake when starting.
Display of selector-lever position flashes	 Gearbox emergency operation	Restricted gearshift comfort, reverse gear fails. Have the fault corrected immediately at a qualified specialist workshop.*
Display of selector-lever position flashes	 Gearbox emergency operation	No selector-lever position is displayed on the instrument panel. Vehicle can be driven only until it comes to a stop. It is not possible to continue driving. Stop the vehicle immediately in a suitable place. Read the instructions in the section "Towing". Have the vehicle towed to a qualified specialist workshop.



















Light in instrument panel	Warning message on multi-function display	Meaning/Action required
	 Fault Transmission	Have the fault corrected at a qualified specialist workshop.*
	 Gearbox temperature too high	“Warning jerks” can be felt when driving off and the engine power may be restricted. Do not hold the vehicle with the accelerator on a hill, for example. Hold the vehicle with the brake. Reduce engine load. Stop the vehicle in a suitable place if possible. Allow the engine to run in selector-lever position P or N until the warning disappears.
	 Press clutch	Manual transmission: Depress clutch pedal when starting.
BRAKE 	 Warning Brake fluid level	Stop immediately in a suitable place. Do not continue driving. Have the fault corrected at a qualified specialist workshop.*
BRAKE 	 Warning Brake force distribution	Stop immediately in a suitable place. Do not continue driving. Have the fault corrected at a qualified specialist workshop.*
ABS 	 ABS failure	Have the fault corrected at a qualified specialist workshop.*
	 Brake pad worn	Have brake pads replaced immediately. Consult a qualified specialist workshop.*
BRAKE  flashes	 Release electric parking brake	Pull the electric parking brake switch
BRAKE 	Press brake pedal.	Press the brake pedal before releasing the electric parking brake.
	 Fault Electric parking brake	Have the fault corrected at a qualified specialist workshop.*











Light in instrument panel	Warning message on multi-function display	Meaning/Action required
BRAKE  flashes	 Emergency brake function	Emergency braking function of the electric parking brake active.
	 PSM failure	Have the fault corrected at a qualified specialist workshop.*
	 PSM off	Porsche Stability Management was switched off.
	 PSM on	Porsche Stability Management was switched on.
	 Fault All-wheel dr. system PSM on	Porsche Traction Management is overloaded. Reduce load. Contact a qualified specialist workshop if the fault persists.*
	 All-wheel dr. system overloaded	Porsche Traction Management is overloaded. Reduce load.
	 Fault All-wheel dr.	Have the fault corrected at a qualified specialist workshop.*
	 Sport mode error	Have the fault corrected at a qualified specialist workshop.*
	 Sport mode not available	Have the fault corrected at a qualified specialist workshop.*
	 Spoiler failure	Driving stability is impaired. Adjust your driving style. Have the fault corrected at a qualified specialist workshop.*
	 Sunroof not closed fully	Close the sunroof.
Warning light for fuel gauge indicator lights up	 Mind remaining distance	Refuel at the next opportunity.





Light in instrument panel	Warning message on multi-function display	Meaning/Action required
	 Fault Fuel indicator	Have the fault corrected at a qualified specialist workshop.*
	 Check fuel tank cap	Position tank cap correctly and screw on until it locks securely.
	 Refill washer fluid	
	 Fasten seat belt	All vehicle occupants must fasten their seat belts.
	 Air bag warning light failure	Have the fault corrected at a qualified specialist workshop.*
	 Steering locked	The steering wheel lock is faulty. Have the fault corrected at a qualified specialist workshop.*
	 Relieve steering	Relieve the steering lock by turning the steering wheel to the left or right.
	 Heated steering wheel on	Steering wheel heating is switched on
	 Heated steering wheel off	Steering wheel heating is switched off
	 Check steering oil level	For vehicles with PDCC: Power steering fluid level too low. Please visit a qualified specialist workshop.*
	 Ignition key not removed	
	 Ignition lock fault	Have the fault corrected at a qualified specialist workshop.*
	 Key not recognized	Make sure that you have the car key with you.
	 Ignition lock faulty	Have the fault corrected at a qualified specialist workshop.*
	 Replace ignition key battery	Replace the battery in the car key.

Light in instrument panel	Warning message on multi-function display	Meaning/Action required
	Fault Porsche Entry & Drive	Have the fault corrected at a qualified specialist workshop.*
	Multiple keys recognized in vehicle	Information message: Several vehicle keys in the vehicle, e.g. in the possession of a passenger.
	Close doors to lock vehicle	Close all doors and the tailgate before locking the vehicle.
	Chassis system fault	Vehicle handling may be affected. Adapt your speed to the changed conditions. Have the fault corrected at a qualified specialist workshop.*
	Chassis system failure	Stop immediately in a suitable place. Do not continue driving. Have the fault corrected at a qualified specialist workshop.*
	Control on	PASM level control is active.
	Control off	PASM level control was switched off, e.g. before driving onto a lifting platform or raising one wheel.
	not allowed	Level adjustment is not permitted, e.g. at speeds above approx. 20 mph (30 km/h) or if the door/tailgate is open.
	not possible	Level adjustment not available, e.g. when the engine is switched off, if the vehicle is overloaded or the battery voltage is too low.
	Vehicle extremely low	The vehicle ground clearance is insufficient to continue driving. The system regulates the vehicle level again automatically. This can take several minutes. Have any persistent faults checked/corrected at a qualified specialist workshop.*
	Vehicle extremely high	The vehicle ground clearance is too high to continue driving. The system regulates the vehicle level again automatically. Have any persistent faults checked/corrected at a qualified specialist workshop.*

Light in instrument panel	Warning message on multi-function display	Meaning/Action required
	 Fault PDCC	Vehicle handling may be affected. Adapt your speed to the changed conditions. Have the fault corrected at a qualified specialist workshop.*
	 PDCC failure	The lateral inclination of the vehicle is significantly greater when cornering. Drive carefully at an appropriate speed to the nearest qualified specialist workshop.*
	 PDCC fault PSM activated	Vehicle handling may be affected. Adapt your speed to the changed conditions. Have the fault corrected at a qualified specialist workshop.*
	 Fault Differential lock	Have the fault corrected at a qualified specialist workshop.*
	 Tire pressure	Tire Pressure Monitoring detects a pressure loss of more than 7 psi (0.5 bar) below 100 mph (160 km/h) and more than 6 psi (0.4 bar) above 100 mph (160 km/h). Stop in a suitable place and check the tires indicated for damage. If necessary, fill in tire sealant and set the correct tire pressure.
	 Inflate!	Tire Pressure Monitoring detects a pressure loss of more than 4 psi (0.3 bar). Correct the tire pressure at the next opportunity.
	 Restricted monitoring	Fault on one or both wheel transmitters. Have the fault corrected at a qualified specialist workshop.*
	 No monitoring System is learning	Tire Pressure Monitoring requires a certain amount of time to learn the wheels. During this time, the current tire pressures are not available on the on-board computer.
	 System not active	Fault in Tire Pressure Monitoring system. Tire pressure is not monitored. Have the fault corrected at a qualified specialist workshop.*

Light in instrument panel	Warning message on multi-function display	Meaning/Action required
	 System not active Temporary fault	Temporary fault in the Tire Pressure Monitoring system. Tire pressure is not monitored.
	 Tire Pressure too low for speeds greater xxx	Top speed for the preset comfort pressure exceeded.
	 Tire change? Update settings	The tire settings on the multi-function display must be updated after changing a wheel.
	 Fault Tire pressure check	Fault in Tire Pressure Monitoring system. Tire pressure is not monitored. Have the fault corrected at a qualified specialist workshop.*
	 Driving light on	Driving light/side light on.
	 Parking light on	Left/right parking light on.
	 Example: Check front left direction indicator	The reported light is faulty. Check bulb. Have the fault corrected at a qualified specialist workshop.*
 flashes	 Dynamic cornering light defective	Have the fault corrected at a qualified specialist workshop.*
 lights up	 Auto driving light control defective	Have the fault corrected at a qualified specialist workshop.*
	 Check static cornering light, left/right	The reported light is faulty. Check bulb. Have the fault corrected at a qualified specialist workshop.*
	 Headlight beam adjust. defective	Adjust your speed and driving style. Have the fault corrected at a qualified specialist workshop.*
	 Rain/light sensor defective	Switch on wipers/light manually. Have the fault corrected at a qualified specialist workshop.*

Light in instrument panel	Warning message on multi-function display	Meaning/Action required
 flashes	 Fault Headlight control	Have the fault corrected at a qualified specialist workshop.*
	 Headlights adapted for LHD/RHD	Headlights have been changed for countries with left/right-hand traffic
	 Wiper defective	Have the fault corrected at a qualified specialist workshop.*
	 Tailgate	Close the tailgate
Example:	Door open	Close door/lid indicated
	 Also: Doors, engine compartment lid	
	 Launch Control activated	Launch Control is activated.
	 Distance! Please brake!	Insufficient distance from vehicle in front.
	 Fault ACC	Adjust your speed and driving style. Have the fault on the adaptive Cruise Control corrected at a qualified specialist workshop.*
	Fault ACC sensor	Adaptive cruise control: Sensor in the front of the vehicle may be covered with dirt, snow, ice or affected by adverse weather conditions.
	 System fault	One or more electrical systems may have failed. Adjust your speed and driving style. Have the fault corrected at a qualified specialist workshop.*
	 Fault Instrument cluster/ ParkAssist sound	Turn signal tones, acoustic warning and distance signals (e.g. for ParkAssist) are not available. Please note this when parking. Have the fault corrected at a qualified specialist workshop.*

Light in instrument panel	Warning message on multi-function display	Meaning/Action required
	 Fault ParkAssist sound	Acoustic warning and distance signals for ParkAssist are not available. Please remember this when parking. Have the fault corrected at a qualified specialist workshop.*
	 Limit 1 or 2 exceeded	Preset speed limit 1 or 2 has been exceeded.
Warning light on the coolant temperature gauge flashes	 Check Engine	Have the fault corrected at a qualified specialist workshop.*
	 Example: Full maintenance in XXX miles (km)	Service reminder Bring the vehicle in for service no later than after the distance/time shown has elapsed. The maintenance intervals can be found in the "Maintenance" booklet.

* We recommend that you have an authorized Porsche dealer to do this work, as they have the trained workshop personnel and the necessary parts and tools for this type of work.

تلفن شبانه روزی: ۰۲۱-۸۸۶۲۰۸۵

FarmaSOS.com

امداد خودرو فارما

تلفن شبانه روزی: ۰۲۱-۸۸۸۶۲۰۸۵

FarmaSOS.com

Driving and Driving Safety

Ignition Lock, Steering Lock.....	164
Starting and Stopping the Engine	167
Auto Start Stop Function.....	169
Electric Parking Brake	171
Brakes	172
Cruise Control.....	176
Adaptive Cruise Control	178
Car Audio Operation/Tips.....	189
Porsche Communication Management (PCM).....	191
iPod®, USB and AUX	192
Voice Control	192
Porsche Doppelkupplung (PDK)	193
Selector-Lever Positions	195
Porsche Traction Management (PTM).....	202
Porsche Stability Management (PSM)	202
ABS Brake System (Anti-Lock Brake System).....	207
Porsche Active Suspension Management (PASM)	208
Porsche Active Suspension Management (PASM) with Air Suspension and Level Control	209
Porsche Dynamic Chassis Control (PDCC) ...	211
“Sport” and “Sport Plus” Mode	212
Sports Exhaust System	214
Retractable Rear Spoiler	214



Ignition Lock, Steering Lock

The ignition key is inserted into the ignition lock underneath the light switch at the left of the steering wheel.

On vehicles **with Porsche Entry & Drive**, you no longer have to insert the key into the ignition lock, but merely keep it with you. The ignition key is replaced by a control unit in the ignition lock, which **always** remains in the ignition lock, unless the vehicle is being towed.

The ignition lock has three key positions. The steering column can be actively locked in a fourth key position on vehicles with Porsche Entry & Drive.



Key positions

- 0 - Initial position
- 1 - Ignition on
- 2 - Start engine

Note on operation

The vehicle battery discharges if the ignition key is left inserted.

If the vehicle battery is dead, the key can only be removed from the ignition lock if the emergency operation is performed:

- ▷ Please see the chapter "EMERGENCY OPERATION – UNLOCKING THE IGNITION KEY" on page 166.



Key positions with Porsche Entry & Drive

- 0 - Initial position
- 1 - Ignition on
- 2 - Start engine
- 3 - Activate steering column lock

Ignition lock position 0 – Initial position

The ignition key cannot be removed when the ignition is switched on or when the engine has been started.

To remove the ignition key:

- ▷ Stop the vehicle.
- ▷ Move PDK selector lever to position P.
- ▷ Switch ignition off.
- ▷ Remove the ignition key.

Ignition lock position 1 – Ignition on

- ▷ Turn ignition key to position **1**.

All electrical equipment can be switched on. The warning lights on the instrument panel light up for a lamp check.

- ▷ Please see the chapter “INSTRUMENT PANEL USA MODELS” on page 107.

If an electrical consumer is not switched on for 10 minutes after switching on the ignition, the ignition must be switched off then on again.

Ignition lock position 2 – Start engine

- ▷ Turn ignition key to ignition lock position **2**.

The car key is reset automatically from position 2 to position 1 when you start the engine.

Ignition lock position 3 – Activate steering column lock on vehicles with Porsche Entry & Drive

- ▷ Please see the chapter “Manually locking the steering column on vehicles with Porsche Entry & Drive” on page 165.

Steering column lock

Vehicles without Porsche Entry & Drive

The steering column is **locked automatically** when the ignition key is removed from the ignition lock and **unlocked automatically** when the ignition key is inserted into the ignition lock.

Vehicles with Porsche Entry & Drive

The steering column is **locked automatically** when the driver’s door is opened when the ignition is switched off.

Manually locking the steering column on vehicles with Porsche Entry & Drive

- ▷ Once the ignition is switched off, turn the control unit to ignition lock position **3** again and hold it there for **2 seconds**. The steering column is locked when you hear a clicking noise.

The steering column can be **unlocked automatically** by turning the control unit to ignition lock position **1**.

Emergency operation with Porsche Entry & Drive

Interference in radio transmission between the vehicle and ignition lock or a discharged ignition lock battery can disable the Porsche Entry & Drive comfort function.

If this happens, the control unit can be removed from the ignition lock and the vehicle can be started using the standard ignition key.

Removing the control unit from the ignition lock

1. Turn the control unit to ignition lock position **3** and hold it there for about 10 seconds.

Once you hear the clicking sound, you can remove the control unit in ignition lock position **0**.



Emergency operation – unlocking the ignition key

If the vehicle battery is dead, the ignition key can be removed only if the emergency operation is performed.

1. Carefully lever off the fuse box cover on the driver's side with a screwdriver and remove it.
2. Unclip metal hook **A** on the inside of the fuse box cover.



3. Use metal hook **A** to remove the plastic cover **B** from the ignition lock. Make sure that plastic cover **B** is not lost.

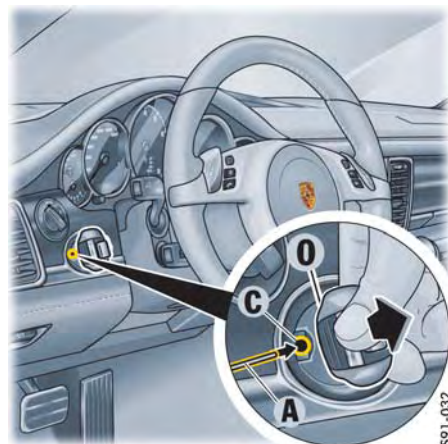

4. Turn ignition key to ignition lock position **O** (initial position).
5. Press metal hook **A** into opening **C**. You will hear an unlocking noise.
6. Remove the ignition key in initial position **O**.
7. Re-fit the plastic cover **B**.

FarmaSOS.com

Starting and Stopping the Engine

The immobilizer can be deactivated and the engine started only using an authorised ignition key.

- ▷ Please see the chapter "IMMOBILIZER" on page 250.

Warning!

Risk of poisoning. Exhaust gas contains colorless and odorless carbon monoxide (CO), which is toxic even in low concentrations. Carbon monoxide can cause unconsciousness and even death if inhaled.

- ▷ Never start or let the engine run in an enclosed, unventilated area. It is not recommended to sit in your car for prolonged periods with the engine on and the car not moving.

An unattended vehicle with a running engine is potentially hazardous. If warning lights should come on to indicate improper operation, they would go unnoticed.

- ▷ Never leave the engine idling unattended.

Danger of fire close to the hot exhaust system.

- ▷ Do not park or drive your vehicle where combustible materials, such as dry grass or leaves, can come into contact with the hot exhaust system.

For information on the emission control system:

- ▷ Please see the chapter "EMISSION CONTROL SYSTEM" on page 262.
 - ▷ If your car catches on fire for any reason, call the fire department. Do not endanger your life by attempting to put out the fire.
-

Starting the vehicle

- ▷ Operate the footbrake.
- ▷ Move PDK selector lever to position **P** or **N**.
- ▷ Do not press the accelerator pedal. The engine control unit will provide the correct starting mixture.
- ▷ Turn the ignition key or control unit (Porsche Entry & Drive) to ignition lock position **2**. The starting process is carried out and completed automatically as soon as ignition lock position **2** (start engine) is reached. The ignition key or control unit is reset automatically to ignition lock position **1** (ignition on).
- ▷ Do not operate the starter for more than approx. 10 seconds. If necessary, repeat the starting procedure after a pause of approx. 10 seconds. Turn the ignition key back to ignition lock position **0** (initial position) first. The first operation of the starter is ended automatically when the engine starts. If the engine does not start, subsequent starter operations will not be ended automatically.

امداد خودرو فارما

تلفن شبانه روزی: ۰۲۱-۸۸۶۲۰۸۵

FarmaSOS.com

- ▷ Do not warm up the engine when stationary. Drive off immediately. Avoid high revs and full throttle until the engine has reached operating temperature.
- ▷ If the vehicle battery power is too weak, the engine can be started with jump leads.

For information on jump-lead starting:

- ▷ Please see the chapter “EXTERNAL POWER SUPPLY, JUMP-LEAD STARTING” on page 306.

Note on operation

To ensure a good battery charge condition, thereby ensuring that the battery will start the engine, all electrical loads that are not required should be switched off when the ignition is switched on and when engine revs are low (in traffic jams, in city traffic or in queues).

Stopping

- ▷ Only remove the ignition key when the vehicle is stationary.
- ▷ Only switch the ignition off when the vehicle is stationary, as there is no power steering and brake booster assistance when the engine is switched off.
- ▷ When leaving the vehicle, **always** remove the ignition key, apply the electric parking brake and engage selector-lever position **P**. The control unit **always** remains in the ignition lock on vehicles with **Porsche Entry & Drive**.



Warning!

Danger of injury. Hot engine compartment components can burn skin on contact.

- ▷ Before working on any part in the engine compartment, turn the engine off and let it cool down sufficiently.

Risk of burn injury when standing near or coming into contact with the exhaust pipe.

The exhaust pipe is hot when the vehicle is running and remains hot for some time after the vehicle is turned off.

- ▷ To prevent injury, make a point of noting where your vehicle's exhaust pipe is, avoid placing your legs near the exhaust pipe when loading and unloading cargo in the rear, and closely supervise children around the vehicle during time when the exhaust pipe could be hot. A hot exhaust pipe can cause painful skin burns.

Radiator fan

For information on radiator fans:

- ▷ Please see the chapter “RADIATOR FANS” on page 258.



Warning!

Danger of injury. After the ignition is switched off, the engine compartment and coolant temperatures are monitored for approx. 30 minutes. During this period, and depending on temperature, the radiator fan may continue to run or start to run.

- ▷ Carry out work in these areas only with the engine off and exercise extreme caution, always anticipating that the fan blade could suddenly start to run.

Auto Start Stop Function

The engine stops automatically when the vehicle is stopped, e.g. at traffic lights or in a traffic jam. The Auto Start Stop function thus helps to save fuel.

The ignition stays on even when the engine switches off automatically. All safety functions are still available.

Stopping the engine

The Auto Start Stop function stops the engine as soon as the vehicle stops moving.

1. Use the footbrake to hold the vehicle in place.
2. Keep the footbrake pressed.
or
Move PDK selector lever to position **P**.

Preconditions for stopping the engine

- Engine compartment lid closed.
- Driver detected: driver's seat belt fastened and driver's door closed.
- PDK selector lever in position **D**, **N** or **P** or transmission range **1** or **2** selected manually.
- Engine, transmission and battery are at operating temperature.
- Vehicle was driven at a speed of more than approx. 1 mph (2 km/h) for at least 1.5 seconds since the engine last stopped automatically.

Starting the engine

The Auto Start Stop function starts the engine:

- ▷ In PDK selector-lever position **D**, **N** or manually selected transmission range **1** or **2**:
Release the footbrake.
or
Press the accelerator.

or

- ▷ Move PDK selector lever to position **R**.

You can drive off normally.

Note

The engine will start automatically in certain situations, e.g. if the vehicle starts rolling, if air conditioning causes reduced comfort, or if the brake booster vacuum is reduced.

Starting the engine manually after leaving the vehicle

If the driver's seat belt is unbuckled or the driver's door is opened after the engine was stopped automatically, the engine will **not** start automatically.

Furthermore, if the brake is released, the engine has to be started manually.

The message "Please start engine manually" will appear on the multi-function display in the instrument panel.

- ▷ Please see the chapter "OVERVIEW OF WARNING MESSAGES" on page 152.

Exceptions for the Auto Start Stop function

The Auto Start Stop function is **not** available in the following situations, for example:

- When Sport mode is activated.
- When PSM is off.
- In Maneuvering mode.
- When AC MAX mode is activated.
- When the "Windshield defrost" function is active.
- While adjusting the chassis level.
- When the rear fog light is on.

The Auto Start Stop function is available **with limited functionality** in the following situations, for example:

- If the air conditioning or passenger compartment heating is operated at a high setting or if the defrost function is run for long time periods.
- If the battery charging condition is low.
- On upward or downward slopes.
- During internal vehicle test procedures, e.g. automatic engine checks.

Note

If one of these situations arises after the engine has stopped automatically, the engine can be restarted automatically.



(A) Switching Auto Start Stop function on and off

Switching Auto Start Stop function off

- ▷ Press button (A).
The indicator light on the button lights up.
The engine's Auto Stop function is disabled.

Switching Auto Start Stop function on

- ▷ Press button (A).
The indicator light on the button goes out.
The engine stops automatically when the vehicle stops.

Auto Start Stop function display

(A) Stopping the engine automatically and restart readiness

If the engine was stopped automatically by the Auto Start Stop function **and** if the driver is detected in the vehicle (driver's seat belt fastened and driver's door closed), the indicator light on the multi-function display in the instrument panel will light up green.

(A) Engine does not stop or is not ready to restart

If the Auto Stop function is not available or if no driver is detected in the vehicle after the engine has stopped automatically (driver's seat belt open or driver's door open), the indicator light on the multi-function display in the instrument panel will light up yellow when the vehicle is stationary.

The Auto Start Stop system has detected that:

- At least one precondition for stopping the engine automatically is not met.
- or
- There is at least one exception for the Auto Start Stop function.

For information on preconditions for stopping the engine automatically:

- ▷ Please see the chapter “PRECONDITIONS FOR STOPPING THE ENGINE” on page 169.

For information on exceptions for the Auto Start Stop function:

- ▷ Please see the chapter “EXCEPTIONS FOR THE AUTO START STOP FUNCTION” on page 169.

Note

If the indicator light in the multi-function display continuously lights up yellow when the vehicle is stopped and if the engine does not stop regularly when the vehicle is stopped despite the fact that the preconditions for stopping the engine automatically are met, this may be an indication that the battery is weak.

- ▷ Have the Auto Start Stop system checked the next time you visit an authorized Porsche dealer.

Fault reporting

If there is a fault, the warning message “Start/Stop mode deactivated” will appear on the multi-function display in the instrument panel.

- ▷ Have the fault corrected at an authorized Porsche dealer.

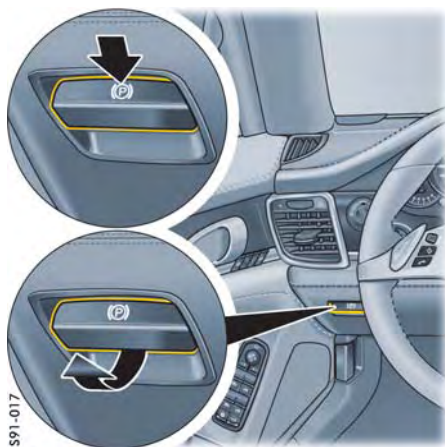

Electric Parking Brake

The electric parking brake acts on the rear wheels and serves to secure the vehicle while parked.

Applying the parking brake

- ▷ Press switch (P).
The brake warning light on the instrument panel lights up.

For information on indicator lights and warning lights on the instrument panel:

- ▷ Please see the chapter “INSTRUMENT PANEL USA MODELS” on page 107.

Releasing the parking brake

The electric parking brake can only be released when the ignition is switched on.

1. Press the brake pedal.
2. Pull switch (P).
The brake warning light on the instrument panel goes out.

Automatic electric parking brake release when driver's intention to drive off is detected

If the engine is running, the driver's door is closed and the driver's seat belt is fastened, it is still possible to drive off even though the parking brake is on. The electric parking brake detects the driver's intention to drive off and releases automatically. The warning light on the instrument panel goes out.

If the driver's door is not closed or the driver's seat belt is not fastened, the electric parking brake will not be released automatically when the driver attempts to drive off.

The message “Release electric parking brake” appears on the multi-function display in the instrument panel. The brake warning light on the instrument panel and the indicator light on the switch (P) start to flash.

For information on warning messages on the multi-function display:

- ▷ Please see the chapter “OVERVIEW OF WARNING MESSAGES” on page 152.

Emergency braking function

If the conventional brake system has failed, the vehicle can be decelerated quickly and braked to a stop using the electric parking brake.

- ▷ Press switch (P) and keep it pressed.
The brake warning light on the instrument panel and the indicator light on the switch (P) start to flash. The message “Emergency brake function” appears on the multi-function display. The emergency braking function is deactivated when you release the switch.

Safety instruction!

Severe braking. Emergency braking takes place with very high braking power.

- ▷ Only use the emergency braking function in an emergency situation.
- ▷ Do not use the emergency braking function to stop the vehicle when driving normally.

BRAKE Brake warning light USA

Brake warning light Canada

If the electric parking brake could not be applied fully when the vehicle is stopped, the brake warning light on the instrument panel starts to flash.

For information on warning messages on the multi-function display:

- ▷ Please see the chapter “OVERVIEW OF WARNING MESSAGES” on page 152.

Brakes

- ▷ Make it a habit to check the operation of your brakes before driving.

Keep in mind that the braking distance increases very rapidly as the speed increases. At 60 mph (100 km/h), for example, it is not twice but four times longer than 30 mph (50 km/h). Tire traction is also less effective when the roads are wet or slippery.

- ▷ Therefore, always maintain a safe distance from the car in front of you.

Vehicles without Porsche Ceramic Composite Brake (PCCB)

Even though the brake discs consist of alloyed grey cast iron, they will unavoidably start to corrode if your car is parked for an extended period. The brakes will tend to “rub” as a result. The nature, extent and effects of corrosion depend on the amount of time the vehicle was parked, whether road salt or grit was spread and whether grease-dissolving agents were used in car washes.

If the braking comfort is noticeably impaired, we recommend having the brake system checked by experts at an authorized Porsche dealer.

Brake system function

Your Porsche is equipped with a power assisted hydraulic dual circuit brake system with disc brakes at the front and rear.

Both circuits function independently. One brake circuit operates the front left and rear right wheel and the other operates the front right and rear left wheel.

If one brake circuit has failed, the other will still operate. However, you will notice an increased pedal travel when you apply the brakes. Failure of one brake circuit will cause the stopping distance to increase.

Warning!

Risk of an accident, resulting in serious personal injury or death.

In the unlikely event of hydraulic failure of one brake circuit:

- ▷ Push the brake pedal down firmly and hold it in that position. A mechanical linkage activates the second circuit, and you will be able to bring the vehicle to a stop.
- ▷ After bringing your vehicle to a complete stop, avoid driving the vehicle and instead have it towed to the nearest authorized Porsche dealer for repair.

Brake system warning light

You can check the functionality of the brake system warning light by switching the ignition to the “On” position (position **1**) and verifying that the warning light illuminates.

BRAKE Brake warning light USA

(!) Brake warning light Canada

The warning light in the instrument panel lights up. A message will be displayed on the multi-function display of the instrument panel if the brake fluid level is too low, or (if the brake pedal travel has increased) one of the two brake circuits has failed.

A greater braking pressure will be required, stopping distances will be longer and the braking behavior will change, particularly in curves.

With correctly adjusted brakes and a correctly working brake system, the pedal travel to the point of brake application should be 1-3/16 in. to 1-9/16 in. (30 to 40 mm). Whenever the brake pedal travel exceeds this value, have the brake system checked.

Brake pedal

(!) Warning!

Risk of an accident, resulting in serious personal injury or death.

Any obstruction of the brake pedal could increase the stopping distance.

- ▷ Always check the movement of the brake pedal before driving and make sure that it is not obstructed by a floor mat or any other object.
- ▷ Secure the floor mat to prevent it from sliding into positions that could interfere with the safe operation of your vehicle. Your Porsche dealer will be glad to offer you floor mats of the correct size including a securing possibility.

Note

In case one of the two brake circuits fails, increased pedal travel is required to bring your vehicle to a full stop.

(!) Warning!

To avoid overheating and premature wear of the brakes:

- ▷ Before descending a steep grade, reduce speed and shift the transmission into a lower gear to control speed.
- ▷ Do not “ride the brakes” by resting your foot on the pedal when not intending to apply brake pressure.
- ▷ Do not hold the pedal down too long or too often. This could cause the brakes to overheat and not function properly.

تلفن شماره موبایل: ۰۲۱-۸۸۶۲۰۸۵
FarmaSOS.com

Brake booster

The brake booster assists braking only when the engine is running.

When the car is moving while the engine is not running, or if the brake booster is defective, more pressure on the brake pedal is required to bring the car to a stop.

Moisture, road salt or grit on brakes affects braking.

Brakes will dry after a few cautious brake applications.

Warning!

Risk of an accident, resulting in serious personal injury or death.

Driving through water may reduce the traction. Moisture on brakes from road water, car wash, or a coating of road salt or grit may affect braking efficiency.

- ▷ Cautiously apply brakes to test brakes after exposure to road water, etc.
-

Brake wear

Your car has excellent brakes, but they are still subject to wear. The rate at which they wear depends on how the brakes are used.

- ▷ Have the brake system inspected at the intervals recommended in your Maintenance Booklet.

Brake system warning light

You can check the functionality of the brake system warning light by switching the ignition to the “On” position (position **1**) and verifying that the warning light illuminates.

Brake wear warning message

A warning message will be displayed on the multi-function display of the instrument panel if the brake pads are worn, excessively. *تلفن شبانه روزی.*

- ▷ Do not continue to operate the vehicle. Have your authorized Porsche dealer inspect or replace the brake pads.

For information on warning messages on the multi-function display:

- ▷ Please see the chapter “OVERVIEW OF WARNING MESSAGES” on page 152.

Brake pads and brake discs

Wear on the brake pads and brake discs depends to a great extent on the driving style and the conditions of use and therefore cannot be expressed in actual miles on the road.

The high-performance brake system is designed for optimal braking effect at all speeds and temperatures.

Certain speeds, braking forces and ambient conditions (e.g. temperature and humidity) can therefore cause the brakes to “squeal”.

New brake pads or linings

New brake pads have to be “broken in”, and therefore only attain optimal friction when the car has covered several hundred miles or km. The slightly reduced braking ability must be compensated for by pressing the brake pedal harder. This applies whenever the brake pads and/or brake discs are replaced.

Warning!

- ▷ Do not obstruct the pedal travel with floor mats or other objects.

The brake booster is ready for operation only while the engine is running.

If the engine is switched off or there is a defect in the brake booster, much greater force has to be applied to the pedal when braking.

- ▷ Vehicles with defective brakes must not be towed and must be transported on a flat bed.

For information on towing and tow-starting:

- ▷ Please see the chapter “TOWING” on page 316.

In heavy rain, while driving through water or after leaving a car wash, the braking action may be delayed and increased pressure may be required.

- ▷ For this reason, keep further back from the vehicle in front and “dry” the brakes by applying them at intervals. Make sure that the traffic behind you is not affected.

After a long drive over salted or gritted roads, a coating may form on the brake discs and pads that significantly reduces friction and therefore also braking effect.

- ▷ Even though the brake discs consist of alloyed grey cast iron, they will unavoidably start to corrode if your vehicle is parked for an extended period. The brakes will tend to “rub” as a result.

The nature, extent and effects of corrosion depend on the amount of time the vehicle was parked, whether road salt or grit was spread and whether grease-dissolving agents were used in car washes (not on vehicles with Porsche Ceramic Composite Brake).

To prevent corrosion of the brake discs, “brake them dry” before parking the vehicle (not on vehicles with Porsche Ceramic Composite Brake).

If braking comfort is noticeably impaired, we recommend that you have the brake system checked by an authorized Porsche dealer.

- ▷ To relieve the brake system on downhill stretches, change down to a lower gear in good time (engine braking). If engine braking is insufficient on steep stretches, operate the footbrake at intervals. Avoid continuous braking as it overheats the brakes and reduces the braking effect.

For information on brake fluid and checking the brake fluid level:

- ▷ Please see the chapter “BRAKE FLUID” on page 258.
-

FarmaSOS.com



- A** - Switch cruise control on/off
1 - Set/increase desired speed
2 - Reduce desired speed
3 - Interrupt (OFF)
4 - Return to set speed (RESUME)

Cruise Control

Cruise control maintains any selected speed between approx. 20–150 mph (30–240 km/h) without you having to use the accelerator. Cruise control is operated using the control stalk at the bottom left of the steering wheel.

Vehicles with PDK

Downshifts are carried out to help maintain the pre-selected speed (especially when driving downhill).



Risk of accident while using cruise control in heavy traffic and consequent personal injury or death, on twisting roads or under unfavorable road conditions (e.g. wintry or wet conditions, varying road surfaces).

- ▷ Do not use the cruise control under such conditions.
- ▷ Observe all local and national speed limits.

Risk of an accident, personal injury and loss of control.

- ▷ Do not reach through the steering-wheel spokes while driving.

FarmaSOS.com

Switching cruise control readiness on

- ▷ Press button **A** on the control stalk.



Cruise control readiness

The grey symbol on the multi-function display in the instrument panel indicates readiness.

Maintaining and storing speed

1. Accelerate or decelerate to the desired speed using the accelerator pedal.
2. Push the control stalk on the steering wheel forward (position **1**).
The current driving speed is now stored as the desired speed, which will be maintained automatically.



Desired speed

The desired speed that was stored is displayed under the cruise control symbol, which has now turned orange.

Accelerating (e.g. to overtake)

Variant 1

- ▷ Increase the speed as usual with the accelerator pedal.
When you ease off the accelerator, the previously stored value is set again.

Variant 2

- ▷ Push the control stalk on the steering wheel forward (position **1**).
The desired speed is increased in steps of 1 mph (1 km/h).
or
Press the control stalk on the steering wheel forward and keep it pressed (position **1**).
The desired speed is increased in steps of 5 mph (10 km/h).

The new desired speed is displayed on the multi-function display in the instrument panel.

Decelerating

- ▷ Briefly pull the control stalk on the steering wheel towards the steering wheel (position **2**).
The desired speed is decreased in steps of 1 mph (1 km/h).
or
Pull the control stalk on the steering wheel towards the steering wheel and keep it pulled (position **2**).
The desired speed is decreased in steps of 5 mph (10 km/h).

The new desired speed is displayed on the multi-function display in the instrument panel.

Vehicles with PDK

Downshifts are carried out to help maintain the pre-selected speed (especially when driving downhill).

تلفن شبانه روزی: ۰۲۱-۸۸۶۲۰۸۵

FarmaSOS.com

Interrupting cruise control operation – OFF

The speed driven before the interruption remains stored in the memory and can be reactivated by pressing the control stalk.

- ▷ Please see the chapter “RESUMING THE STORED SPEED – RESUME” on page 178.
- ▷ Press the control stalk down (position **3**).
or
Press the brake or clutch pedal **or** move the PDK selector lever to position **N**.

For more information on driving with Porsche Doppelkupplung:

- ▷ Please see the chapter “PORSCHE DOPPELKUPPLUNG (PDK)” on page 193.

Cruise control operation is interrupted automatically:

- If the set vehicle speed is exceeded by more than approx. 16 mph (25 km/h) for longer than 20 seconds.
- If the actual vehicle speed falls below the set vehicle speed by approx. 37 mph (60 km/h) for longer than 60 seconds (e.g. gradients).
- If Porsche Stability Management (PSM) intervenes for longer than 0.5 seconds.

Resuming the stored speed – RESUME

- ▷ Press the control stalk up (position **4**).
Cruise control accelerates/decelerates the vehicle to the stored speed.

Note on operation

The stored speed should only be recalled if traffic and road conditions are conducive to driving at that speed.

Switching cruise control readiness off

- ▷ Press button **A** on the control stalk.
The memory is cleared and the readiness symbol disappears.

The stored desired speed is cleared when the ignition is switched off when the vehicle is parked.

Tip on driving

On upward or downward slopes, the set speed cannot always be maintained by cruise control.

- ▷ To obtain sufficient engine braking or a better rev range, you therefore have to change down to a lower gear.

Adaptive Cruise Control

Adaptive cruise control maintains any selected speed between approx. 20–100 mph (30–160 km/h) when driving on open roads without you having to use the accelerator.

If a vehicle travelling ahead of you in the same lane is detected as driving slower than the selected speed, adaptive cruise control will automatically maintain a set distance from the vehicle in front. Adaptive cruise control slows your vehicle down if the distance to the vehicle ahead becomes too short and accelerates your vehicle if the distance increases.



Risk of accidents in heavy traffic, in city traffic, on twisting roads or in unfavorable road conditions (e.g. wintry or wet conditions or varying road surfaces, etc.).

- ▷ Do not use adaptive cruise control under these conditions.

Adaptive cruise control will not detect stationary or slowly moving vehicles, pedestrians, objects on the road, oncoming vehicles in the same lane or cross traffic.

- ▷ You must pay attention to your vehicle's position in relation to other objects and intervene as needed to ensure safe driving.
- ▷ Always keep the direction of travel in your field of view.

S91-209



Radar sensor

Adaptive cruise control uses a radar sensor located in the middle of the front apron.

Maintenance note

- ▷ Always keep the radar sensor clean and free of ice and snow to ensure that it is fully functional.

For car care instructions:

- ▷ Please see the chapter “CAR CARE INSTRUCTIONS” on page 269.

Radiofrequency radiation exposure Information

This equipment complies with FCC radiation exposure limits set forth for an uncontrolled environment. This equipment should be installed and operated with minimum distance of 8 in. (20 cm) between the radiator and your body.

This transmitter must not be co-located or operating in conjunction with any other antenna or transmitter



Warning!

Risk of accidents. Radar sensor vision can be impaired by rain, snow, ice or heavy spray. Vehicles in front will not be detected properly or may not be detected at all.

- ▷ Do not use adaptive cruise control under these conditions.

Warning message

Adaptive cruise control can be deactivated automatically if the radar sensor is very dirty or iced up, obstructed, in unfavorable weather conditions (heavy rain) or when driving through tunnels.

The message “Fault ACC sensor” will appear on the multi-function display in the instrument panel.

For information on warning messages on the multi-function display:

- ▷ Please see the chapter “OVERVIEW OF WARNING MESSAGES” on page 152.

Notes

This device complies with Part 15 of the FCC Rules and with RSS-210 of Industry Canada. Operation is subject to the following two conditions:

1. This device may not cause harmful interference, and
2. this device must accept any interference received, including interference that may cause undesired operation.

Changes or modifications made to this equipment not expressly approved by Porsche may void the FCC authorization to operate this equipment.

This equipment has been tested and found to comply with the limits for a Class A digital device, pursuant to Part 15 of the FCC Rules. These limits are designed to provide reasonable protection against harmful interference when the equipment is operated in a commercial environment. This equipment generates, uses, and can radiate radio frequency energy and, if not installed and used in accordance with the instruction manual, may cause harmful interference to radio communications. Operation of this equipment in a residential area is likely to cause harmful interference in which case the user will be required to correct the interference at his own expense.

This Class A digital apparatus complies with Canadian ICES-003.

Cet appareil numérique de la classe A est conforme à la norme NMB-003 du Canada.

Operating principle of adaptive cruise control

No vehicle detected in front – open road driving

Adaptive cruise control operates like a cruise control system. The desired speed that was set is maintained constantly.

Vehicle detected in front – driving in traffic

If a vehicle travelling ahead of you in the same lane is detected as driving slower than the selected desired speed, adaptive cruise control will automatically maintain a set distance from the vehicle in front.

If the vehicle in front stops, adaptive cruise control will slow your vehicle down to a stop provided this is possible within the control limits of the system. Adaptive cruise control actively keeps your vehicle at a standstill.

If the vehicle in front drives off, automatic speed control and distance control can be resumed.

Override

The speed of the vehicle can be increased at any time by pressing the accelerator.

If the set ACC speed is exceeded, the ACC is deactivated.

The message “ACC passive” will appear on the multi-function display in the instrument panel.

The desired speed that was stored is retained.

After releasing the accelerator pedal, the ACC accelerates to the desired speed if there is no vehicle in front and controls the distance if a vehicle in front is present.

For information on the “ACC passive” status:

- ▷ Please see the chapter “OPERATING STATES WHEN ADAPTIVE CRUISE CONTROL IS SWITCHED ON” on page 182.



- R** - Switch adaptive cruise control on/off
- 1** - Set/increase desired speed
- 2** - Reduce desired speed
- 3** - Interrupt (OFF)
- 4** - Operational readiness on/return to set speed (RESUME)

Using adaptive cruise control

Adaptive cruise control is operated using the control stalk at the bottom left of the steering wheel.

Note on operation

You can intervene manually at any time by pressing the brake or accelerator.

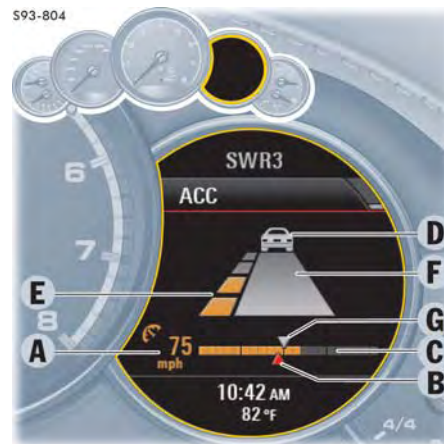

- A** - Status display and desired speed
- B** - Current speed
- C** - Progress bar showing speed control range (0–100 mph, 0–160 km/h)
- D** - Vehicle detected in front
- E** - Desired distance from vehicle in front
- F** - Current distance from vehicle in front
- G** - Current speed of vehicle travelling in front

Adaptive cruise control display

All important information, messages and warnings are displayed on the multi-function display in the instrument panel.

“ACC” main menu

The adaptive cruise control display on the multi-function display can be selected permanently using the buttons on the multifunction steering wheel or the control stalk at the bottom right of the steering wheel.

For information on using the multi-function display:

- ▷ Please see the chapter “OPERATING THE MULTI-FUNCTION DISPLAY IN THE INSTRUMENT PANEL” on page 115.

1. Select
> “ACC”
in the main menu.

Status display

When adaptive cruise control is switched on, the status display **A** appears at the bottom left of the multi-function display.



The status display **A** turns orange when adaptive cruise control is active.
The status display **A** is grey when adaptive cruise control is inactive.

تلفن شبانه روزی: ۰۲۱-۸۸۸۶۲۰۸۵

FarmaSOS.com

Examples:



If adaptive cruise control is switched on, and no desired speed is stored, the cruise control symbol appears but the desired speed field remains blank.



If a desired speed is stored and no vehicle was detected in front, the cruise control symbol and the desired speed are displayed.



If a desired speed is stored and a vehicle was detected in front, a vehicle symbol and the desired speed are displayed.



If the distance from the vehicle in front is less than a safety distance which is dependent on the set desired distance, a yellow warning triangle appears when adaptive cruise control is not active.

Switching adaptive cruise control on and off

Switching adaptive cruise control on

- ▷ Press button **R** on the control stalk. The grey status display appears on the multi-function display. Adaptive cruise control is ready.

Switching adaptive cruise control off

- ▷ Press button **R** on the control stalk. “ACC off” appears on the multi-function display. The desired speed that was stored is deleted. The desired distance is set to the default value.

Operating states when adaptive cruise control is switched on

There are three possible operating states when adaptive cruise control is switched on.

Adaptive cruise control active

Adaptive cruise control automatically regulates the speed and distance from the vehicle in front. The status display **A** turns orange.

Adaptive cruise control is ready

Cruise control and distance control is inactive after pressing the brakes or interrupting by pressing the control stalk down (position **3, OFF**). The desired speed that was stored and the desired distance that was set are retained. The status display **A** turns grey. Adaptive cruise control is active again after you release the accelerator.

For information on resuming cruise control and distance control:

- ▷ Please see the chapter “RESUMING CRUISE CONTROL AND DISTANCE CONTROL – RESUME” on page 185.

Adaptive cruise control passive

Cruise control and distance control is inactive after pressing the accelerator. “ACC passive” appears on the multi-function display. The desired speed that was stored and the desired distance that was set are retained. The status display **A** turns grey. Adaptive cruise control is active again after you release the accelerator.

Setting and changing the desired speed

Preconditions

- ACC is switched on.
- Vehicle is moving.
- No stationary objects are detected in front.

Setting the desired speed

1. Press the control stalk on the steering wheel forward (position **1**). The current driving speed is stored as the desired speed, which will be maintained automatically (within the control range from 20 to 100 mph, 30 to 210 km/h), and appears orange in the status display **A**. The red triangle **B** under the progress bar for the speed control range shows the speed of your vehicle.
2. Release the accelerator pedal. The desired speed is maintained automatically unless a vehicle travelling in front is detected as driving slower than the desired speed.

Note

If your vehicle is stopped, the message “Impossible when parked” appears on the multi-function display when you press the control stalk forward (position **1**).

If a stationary object was detected in front, the message “Stationary object” appears on the multi-function display.

Increasing the desired speed

- ▷ Push the control stalk on the steering wheel forward (position **1**).

The desired speed is increased in steps of 1 mph (1 km/h).

or

Press the control stalk on the steering wheel forward and keep it pressed (position **1**).

The desired speed is increased in steps of 5 mph (10 km/h).

The status display **A** shows the new desired speed.

The red triangle **B** under the progress bar for the speed control range shows the speed of your vehicle.

Reducing the desired speed

- ▷ Briefly pull the control stalk on the steering wheel towards the steering wheel (position **2**). The desired speed is decreased in steps of 1 mph (1 km/h).

or

Pull the control stalk on the steering wheel towards the steering wheel and keep it pulled (position **2**).

The desired speed is decreased in steps of 5 mph (10 km/h).

The status display **A** shows the new desired speed.

The red triangle **B** under the progress bar for the speed control range shows the speed of your vehicle.



Setting the desired distance

The desired distance from the vehicle in front can be set in four stages.

Note on operation

When you are setting the desired distance, the "ACC" main menu for adaptive cruise control is displayed temporarily on the multi-function display.

Initial actuation of the rocker switch **Z** displays the "ACC" main menu, without changing the desired distance.

Note

The distance depends on the driving speed. The slower the vehicle is travelling, the shorter the distance and the faster the vehicle is travelling, the longer the distance.

Increasing the desired distance

- ▷ Press the rocker switch **Z** up. The desired distance is increased. There are more orange segments shown in the desired distance display **E**.

Reducing the desired distance

- ▷ Press the rocker switch **Z** down. The desired distance is reduced. There are fewer orange segments shown in the desired distance display **E**.

Display showing distance from vehicle in front

If a vehicle is detected in front, the vehicle symbol **D** appears on the multi-function display and in the status display **A**.

The grey area **F** shows the current distance from the vehicle in front.

Possible distance settings



Suitable for speedy driving in lines of traffic. The time headway is 1 second. This corresponds to 36 yd. (33 meters) at a speed of 75 mph (120 km/h).



Suitable for driving comfortably in lines of traffic. The time headway is 1.3 seconds. This corresponds to 47 yd. (43 meters) at a speed of 75 mph (120 km/h).



Preset distance

Corresponds to the general recommendation of the road traffic safety regulation (“two seconds time headway”). The time headway is 1.8 seconds. This corresponds to 66 yd. (60 meters) at a speed of 75 mph (120 km/h).



Suitable for driving on country roads. The time headway is 2.3 seconds. This corresponds to 63 yd. (58 meters) at a speed of 56 mph (90 km/h).

Automatic braking to a stop

If the vehicle in front stops, adaptive cruise control will slow your vehicle down to a stop provided this is possible within the control limits of the system. The display **HOLD** lights up on the instrument panel. The vehicle is actively held at a stop.

For information on the HOLD function:

- ▷ Please see the chapter “HOLD FUNCTION: DRIVE-OFF ASSISTANT AND STANDSTILL MANAGEMENT” on page 206.

Note

Depending on the traffic flow, e.g. slow moving traffic, stopping is initiated by a slow crawling phase which ends in vehicle standstill.

Caution!

Brake pedal feels different. When adaptive cruise control is operating normally or when the HOLD function is active, the brake pedal may feel different and you may hear hydraulic noises.

This behavior is normal for the system. It is not a fault.

Driving off again

The vehicle can be driven off again after being stopped and speed and distance control will be resumed, depending on the operating state of the adaptive cruise control system.

For information on the operating states of the adaptive cruise control system:

- ▷ Please see the chapter “OPERATING STATES WHEN ADAPTIVE CRUISE CONTROL IS SWITCHED ON” on page 182.

Adaptive cruise control active

1. Press the control stalk on the steering wheel up (position **4, RESUME**).
2. Briefly press the accelerator pedal. Your vehicle drives on automatically.

Note

Your vehicle will not drive off if the vehicle detected in front is stationary.

Adaptive cruise control is ready

Automatic speed and distance control can only be resumed when your vehicle is moving.

1. Drive off normally.
2. Press the control stalk on the steering wheel up (position **4, RESUME**).
or
Set or change the desired speed.

Interrupting and resuming cruise control and distance control

Interrupting cruise control and distance control – OFF

- ▷ Press the brake pedal.

or

Press the control stalk on the steering wheel down (position **3**, **OFF**).

Adaptive cruise control is inactive.

The desired speed that was stored and the desired distance are retained.

Resuming cruise control and distance control – RESUME

- ▷ Push the control stalk on the steering wheel up (position **4**, **RESUME**).

The vehicle accelerates to the desired speed that was stored unless a vehicle travelling in front is detected as driving slower than the desired speed and the distance from this vehicle is less than the desired distance that was set.

The status display **A** changes from grey to orange.

or

Press the control stalk on the steering wheel up and keep it pressed (position **4**, **RESUME**).

The vehicle accelerates in a more sporty driving style to the desired speed that was stored.

Note on operation

If speed and distance control was interrupted using the control stalk **3 (OFF)**, it can only be resumed again when the vehicle is moving and no stationary objects are detected in front.

Warning messages



Distance warning when adaptive cruise control is inactive (ACC passive)

If adaptive cruise control is not active, the control system still monitors the distance from the vehicle in front.

If the distance from the vehicle in front is less than the desired distance that was set last, a yellow warning triangle appears on the multi-function display.



Warning!

Risk of accidents. Danger of collision with the vehicle in front.

- ▷ Drive with extreme care.
- ▷ Slow down if necessary.

593-814



Overtake request when adaptive cruise control is active (ACC active)

If adaptive cruise control detects that braking assistance is required on the part of the driver, a warning signal sounds and the warning message “Distance! Please brake!” appears on the multi-function display.



Warning!

Risk of accidents. Danger of collision with the vehicle in front.

- ▷ Brake immediately.

Exceptions for adaptive cruise control

Adaptive cruise control is **not** available in the following situations:

- If the ignition is switched off.
- When PSM is off.
- If the driver's door is opened and the driver's seat belt is not fastened.
- When parking or maneuvering in very tight spaces.
- If the PDK selector lever is at position **N**, **R** or **P**.
- On upward or downward slopes of more than 20 %.
- When the electric parking brake is activated.

If one of these exception situations occurs when adaptive cruise control is switched on, adaptive cruise control will be switched off.

A message to this effect will appear on the multi-function display.

Messages on the multi-function display

If adaptive cruise control was deactivated automatically or if an action cannot be performed, a message to this effect in blue appears on the multi-function display.

- **“ACC not available!”**
Adaptive cruise control is not available, e.g. when maneuvering.
- **“ABS/PSM intervention!”**
Adaptive cruise control was deactivated because ABS or PSM intervened as a control mechanism.
- **“Electric parking brake!”**
Adaptive cruise control was deactivated because the electric parking brake was activated.
- **“Selector position!”**
Adaptive cruise control was deactivated because the PDK selector lever is not in position **D** or manual position **M**.
- **“Impossible while parked”**
The required action is not possible because your vehicle is stationary, e.g. when setting a desired speed.
- **“Speed!”**
Adaptive cruise control was deactivated because the rpm limit of the engine was reached in manual position **M** of the PDK selector lever.

- **“Gradient too steep!”**
The desired distance or the desired speed cannot be set because the gradient on the road is too steep.
- **“Stationary object”**
The action is not possible because a stationary object was detected ahead.
- **“PSM off!”**
Adaptive cruise control is not available because PSM was switched off.

For information on Porsche Stability Management (PSM):

- ▷ Please see the chapter “PORSCHE STABILITY MANAGEMENT (PSM)” on page 202.

General information

“Sport” and “Sport Plus” mode

Adaptive cruise control regulates your driving more dynamically in “Sport” and “Sport Plus” mode.

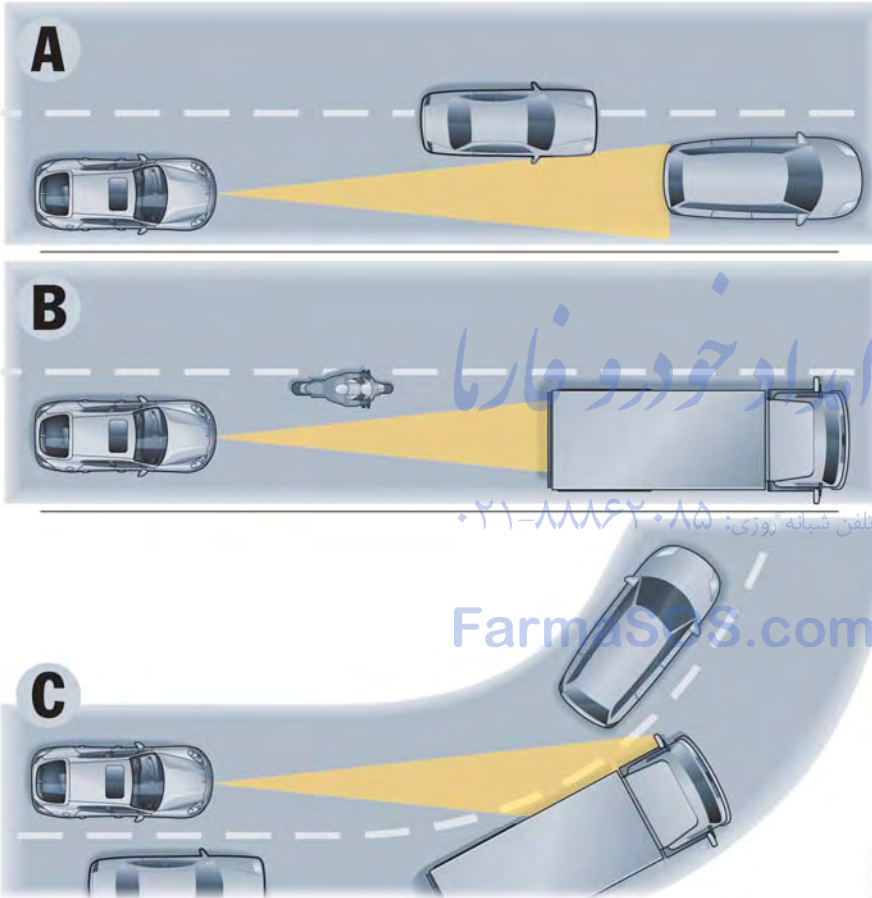

Traffic situations in which vehicles are not reliably detected

The radar sensor for adaptive cruise control scans a narrow, cone-shaped area in front of your vehicle.

Detection can be limited or unreliable, depending on the traffic situation and the size of the vehicle in front. The system may brake too late or unexpectedly. Stationary vehicles are not detected. The system is unable to react to them.

Tip on driving

- ▷ Drive with extreme care.
- ▷ Slow down if necessary.

A – Vehicles changing lanes/cutting in

If a vehicle is changing lanes or cutting in ahead of you in the same lane, the vehicle will only be detected when it has moved completely into your lane.

B – Vehicles with a small cross-section/narrow vehicles

Narrow or small vehicles will not be detected or will be detected too late.

C – Driving into and out of corners

When driving into and out of corners, vehicles will not be detected or will be detected too early, or adaptive cruise control will react to vehicles in adjacent lanes.

S91-274

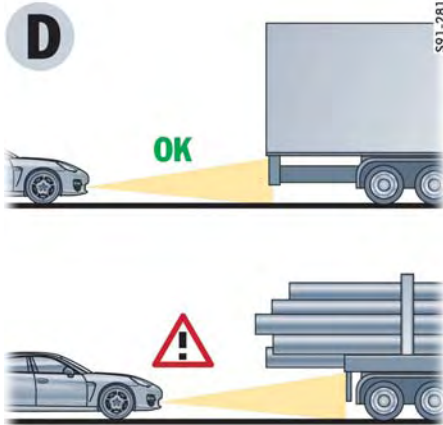

D – Vehicles with large overhangs

The tail of the vehicle will not be detected correctly on vehicles with large overhangs, e.g. lumber trucks.

Warning!

Risk of accidents. Danger of collision with the vehicle in front.

- ▷ Drive with extreme care.
- ▷ Slow down if necessary.

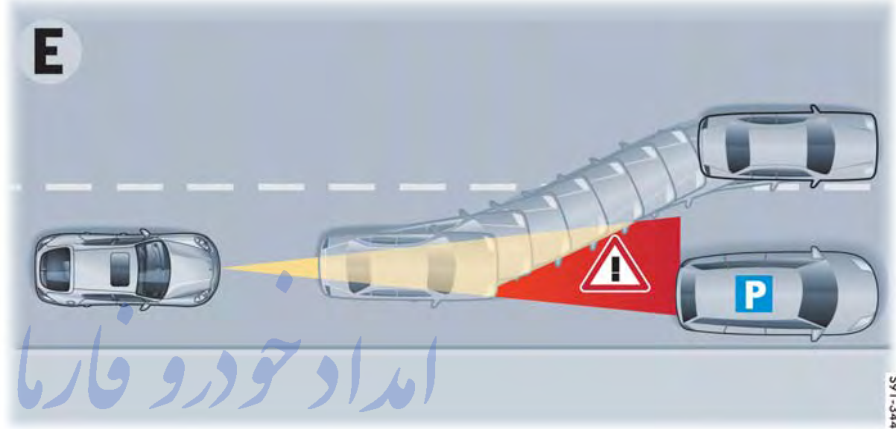

E – Stationary vehicles

A stationary vehicle that appears suddenly in the detection field of the radar sensor, e.g. after a vehicle in front changes lanes, will not be detected by the ACC.

FarmaSOS.com

Warning!

Risk of accidents. Danger of collision with the stationary vehicle.

- ▷ Drive with extreme care.
- ▷ Slow down if necessary.

Car Audio Operation/Tips

For radio operation see your radio manual which is included with your on-board literature.

FM reception

A vehicle is not an ideal place to listen to a radio. Because the vehicle moves, reception conditions are constantly changing.

Buildings, terrain, signal distance and noise from other vehicles are all working against good reception.

Some conditions affecting FM may appear to be problems when they are not.

The following characteristics are completely normal for a given reception area, and they do not indicate any problem with the radio itself.

Note

Electronic accessories should only be installed by your authorized Porsche dealer. Equipment which has not been tested and approved by Porsche may impair radio reception.

Fading and drifting

FM range is limited to about 25 miles (40 km), except for some high power stations.

If a vehicle is moving away from the desired station's transmitter, the signal will tend to fade and/or drift. This condition is more prevalent with FM than AM, and is often accompanied by distortion.

Fading and drifting can be minimized to a certain degree by careful attention to fine tuning or selection of a stronger signal.

Static and fluttering

When the line-of-sight link between a transmitter and vehicle is blocked by large buildings or mountains, the radio sound may be accompanied with static or fluttering because of the characteristic of FM.

In a similar effect, a fluttering noise is sometimes heard when driving along a tree-lined road.

This static and fluttering can be reduced by adjusting the tone control for greater bass response until the disturbance has passed.

Multipath

Because of the reflecting characteristics of FM, direct and reflected signals may reach the antenna at the same time (multipath) and cancel each other out.

As a vehicle moves through these electronic dead spots, the listener may hear a momentary flutter or loss of reception.

Station swapping

When two FM stations are close to each other, and an electronic dead spot, such as static or multipath area, interrupts the original signal, some-times the stronger second signal will be selected automatically until the original one returns.

This swapping can also occur as you drive away from the selected station and approach another station of a stronger signal.



Compact disc player



To avoid damage to compact disc player and discs.

- ▷ Use only compact discs labeled as shown, having no dirt, damage or warpage.
- ▷ Never attempt to disassemble or oil any part of the player unit. Do not insert any object other than a disc into the slot. Remember there are no user-serviceable parts inside the compact disc player.
- ▷ Do not allow the disc to sustain any fingerprints, scrapes or stickers on the surfaces. This may cause poor sound quality. Hold the disc only on the edge or center hole.
- ▷ When not in use, take the disc out of the player, put the disc back into its case and store it away from dust, heat, damp and direct sunlight.
Leaving the disc on the dashboard in the sun can damage the disc.

- ▷ If the disc gets dirty, clean the disc by wiping the surfaces from the center to the outside in a radial direction with a soft cloth. Do not use a conventional record cleaner or anti-static record preservative. Disc cleaners are available in audio stores.

Car Telephone and Aftermarket Alarms

Important legal and safety information regarding the use of cellular telephones

Some states may prohibit the use of cellular telephones while driving a vehicle. Check the laws and regulations on the use of cellular telephones in the areas where you drive.



Risk of an accident. Severe personal injury or death can result in the event of an accident. Looking away from the road or turning your attention away from your driving can cause an accident and lead to serious personal injury or death.

When using your cellular telephone, you should always:

- ▷ Give full attention to your driving – pull off the road and park before making or answering a call if traffic conditions so require, and

- ▷ Keep both hands on the steering wheel – use hands-free operation (if available) – pull off the road and park before using a hand-held telephone.

It is essential to observe the telephone manufacturer's instructions before operating the telephone.

Any portable telephone or radio transmitter which is used in a Porsche must be properly installed in accordance with the technical requirements of Porsche.

The transmission power must not exceed 10 W.

The devices must possess a type approval for your vehicle and have an “e” symbol.

If you should require equipment with transmission power values greater than 10 W, please consult your authorized Porsche dealer for this purpose. They are familiar with the technical requirements for installing devices of this kind.

The antennas for all radios and telephones with a transmitting antenna must be externally mounted.

The improper installation of radios or telephones or use of a radio or telephone with a transmitting antenna inside the car may cause **the warning lights to come on.**

Improper installation of such equipment can create a discharged battery or excessive current draw from added equipment.

If aftermarket systems are installed by non-dealership technicians or outside the selling dealer, problems may result. Installation of aftermarket equipment is not covered under the New Car Warranty.

- ▷ Consult your authorized Porsche dealer about the installation of non-Porsche approved equipment.

Reception quality

The reception quality of your car telephone will change constantly when you are driving. Interference caused by buildings, landscape and weather is unavoidable. It may become particularly difficult to hear when using the hands-free function due to external noise such as engine and wind noise.

Automatic car-wash

- ▷ Unscrew external antennas before using an automatic car-wash.

Porsche Communication Management (PCM)



There is danger of accident if you set or operate the on-board computer, radio, navigation system, telephone or other equipment when driving. This could distract you from traffic and cause you to lose control of the vehicle resulting in serious personal injury or death.

- ▷ Operate the components while driving only if the traffic situation allows you to do so safely.
- ▷ Carry out any complicated operating or setting procedures only with the vehicle stationary.
- ▷ If it is necessary to operate these components while the vehicle is in motion, use the function keys on the multi-functional steering wheel.
- ▷ Refer to the separate operating instructions before putting the PCM into operation.

When put into operation for the first time, a distance of approx. 3 miles (5 km) must be driven in order for the navigation system to complete the process of fine calibration. The same applies when the tires are changed (e.g. summer/winter tires) or new tires fitted. Full location accuracy is not yet achieved during the fine-calibration process.

If the vehicle has been transported (e.g. ferry, car train), the system may take a few minutes after being switched on before it determines the current location.

Serious tire slip (e.g. spinning wheels on snow) may result in temporarily inaccurate navigation.

When the battery has been disconnected, it may take up to 15 minutes before the navigation system is operational once more.

Satellite radio

You must have the satellite radio activated before you can put it into operation. You will need a contract with a provider in order to use this radio.

- ▷ Refer to the separate radio operating instructions before putting into operation.



iPod®, USB and AUX

The iPod®, USB and AUX interfaces are located in the storage compartment between the front seats.

- ▷ Please refer to the chapter “External audio source” in the separate PCM operating instructions.

Note

Do not leave your iPod®, USB storage device or an external audio source in the vehicle for extended periods of time because extreme ambient conditions (temperature fluctuations, humidity) can occur in the vehicle.



Voice Control

Porsche Communication Management (PCM) can be operated by spoken commands using the voice control system.

- ▷ Please refer to the chapter “VOICE CONTROL” in the separate PCM operating instructions.

Activating voice control

- ▷ Press button . An acoustic signal sounds and help text for using the five most important voice commands appears on the multi-function display in the instrument panel. Simply say the command.

For information on switching the help text on and off on the multi-function display:

- ▷ Please see the chapter “DISPLAYING PCM INFORMATION ON THE MULTI-FUNCTION DISPLAY” on page 141.

Porsche Doppelkupplung (PDK)

Porsche Doppelkupplung (PDK) is a seven-speed transmission with an “automatic” and a “manual” selection mode.

In **automatic selection mode** (selector-lever position **D**), gear changing is automatic. You can change temporarily from automatic to manual mode using the shift buttons on the steering wheel.

In **manual selection mode** (selector-lever position **M**), you change gear using the shift buttons on the steering wheel or with the PDK selector lever.

You can change between selector-lever positions **D** and **M** as you wish while driving.

Note

- ▷ Take care not to operate the shift buttons on the steering wheel inadvertently in either automatic or manual mode, thereby triggering undesired gear changes.

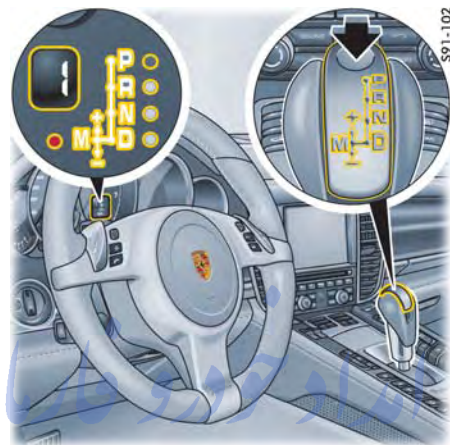

Changing the selector-lever position

The selector lever is blocked when the ignition is switched off.

When the ignition is switched on, the selector lever can be moved from position **P** and **N** only when the release button is pressed, and when the brake pedal is pressed.

Release button

The release button (**arrow**) in the selector lever prevents the gear from being changed unintentionally.

The release button must be pressed when shifting to position **R** or **P**.

Starting

The engine can only be started using the car key if the brake pedal is pressed and the selector lever is in position **P** or **N**.

Driving off

- ▷ Only select the desired position for driving off (**D**, **M** or **R**) when the engine is idling and the brake pedal is pressed.
- ▷ Since the vehicle crawls when in gear, do not release the brake until you are ready to drive off.

Driving off on hills

The Drive-Off Assistant assists the driver when driving off on hills. The vehicle is held on the slope when the driver changes from the brake pedal to the accelerator to facilitate driving off immediately after the brake is released.

- ▷ Please see the chapter “HOLD FUNCTION: DRIVE-OFF ASSISTANT AND STANDSTILL MANAGEMENT” on page 206.



Display for selector-lever position and engaged gear

When the engine is running, the display shows the selector-lever position and engaged gear.

If the selector lever is between two positions

Effects:

- The corresponding selector-lever position on the instrument panel flashes **and** the warning “Press brake” or “Selector not engaged” appears on the multi-function display.

Action required:

- ▷ Operate the footbrake and engage the selector lever properly.

If the selector lever is inadvertently changed from **P** or **N** into a gear (due to a fault or improper use) without pressing the brake, this gear will also “flash” on the display and no power transmission will occur. To drive off, press the brake and move the selector lever from **P** or **N** into the required gear again.

Selector-lever position R or D flashes in the instrument panel

Effects:

- No power transmission occurs. The selector lever was engaged without pressing the footbrake or only the reduced driving program is available when the message “Gearbox emergency operation” appears. تلفن

Action required:

- ▷ Press the footbrake and engage the required selector-lever position again from **P** or **N**. If reverse gear fails:
- ▷ Please see the chapter “REDUCED DRIVING PROGRAM” on page 199.

If there is a fault in the transmission:

The “Gearbox emergency operation” warning in yellow or red or the warning “Gearbox temperature too high” appears on the multi-function display.

- ▷ Please see the chapter “REDUCED DRIVING PROGRAM” on page 199.
- ▷ Have the fault corrected immediately. Please contact a qualified specialist workshop. We recommend that you have an authorized Porsche dealer to do this work as they have trained workshop personnel and the necessary parts and tools.

Selector-Lever Positions

P – Parking lock

- ▷ Engage parking lock only when the vehicle is stationary.
If selector-lever position **P** is flashing in the instrument panel, the parking lock is not engaged. The vehicle can roll away.
Shift again from selector-lever position **R** to **P**.
- ▷ Activate the electric parking brake and then engage the parking lock.
If selector-lever position **P** is flashing in the instrument panel, the parking lock is not engaged. The vehicle can roll away.
Shift again from selector-lever position **R** to **P**.

The **ignition key** can be removed only in selector-lever position **P**.

R – Reverse gear

- ▷ Select only if the vehicle is stationary and the brake is applied.

N – Neutral (idling)

Selector-lever position **N** must be selected for towing or in car washes, for example.

- ▷ Only select the desired position for driving off (**D**, **M** or **R**) when the engine is idling and the brake pedal is pressed.

D – Automatic selection mode

Select position **D** for “normal” driving. The gears are shifted automatically according to the accelerator position and speed.

Depending on the way the vehicle is driven (economical, comfortable or sporty driving style) and on the resistance (e.g. uphill), the gear-changing points are shifted towards higher or lower engine-speed ranges.

The accelerator position, driving speed, engine speed, longitudinal and lateral acceleration and the road profile all have an influence on the gear-changing characteristic.

Unwanted upshifts, e.g. when entering bends, are prevented by swiftly releasing the accelerator pedal.

Depending on lateral acceleration, upshifts on bends are not made until the engine-speed limit is reached.

When you brake, and depending on the amount of deceleration, the PDK transmission changes down earlier.

For subsequent cornering, the right gear is engaged when pressure is applied to the brakes before the bend. The bend is taken in the right gear, and when you accelerate out of the bend you do not have to change down.

With a sporty driving style, downshifts are already initiated when the brake pedal is touched lightly. This further enhances a dynamic driving style.

The PDK transmission temporarily changes to the sportiest gear-changing map, i.e. to the highest possible gear-changing points, if the accelerator pedal is pressed quickly. The transmission accordingly shifts down immediately by one or two gears (temporary change-down).

The transmission no longer selects 7th gear at high driving speeds.

“Sport” and “Sport Plus” Mode

“Sport” mode activated:

The PDK transmission switches to a sporty gear-changing map and shortens the shifting times. A sporty driving style is recognized more quickly and the gear-changing speeds are adapted to driving performance.

Deceleration downshifts are initiated earlier. Downshifts occur for small decelerations, even at high revs.

“Sport Plus” mode activated:

In “Sport Plus” mode, the PDK transmission changes to a shift program designed for driving on race circuits. 7th gear is not selected. The gear-changing performance is enhanced significantly again compared with “Sport” mode.

- ▷ Please see the chapter ““SPORT” AND “SPORT PLUS” MODE” on page 212.

Driving off with Launch Control

Launch Control allows you to achieve maximum acceleration from standstill.

Warning!

There is a risk of endangering other road users if you use this Control in an improper location or in a situation where other persons might need to take evasive action due to the rapid acceleration that this technology permits.

Launch Control is designed to be used in a controlled environment on closed circuit driving courses where no vehicle cross traffic or pedestrian traffic is present.

- ▷ Use Launch Control only if conditions permit it to be applied in a safe manner.
- ▷ Do not use Launch Control if there is a possibility it could endanger other persons. Such a possibility exists if you cannot see that you have a clear road with no possibility of cross traffic in your intended direction of driving.

Caution!

Stress on components increases dramatically when starting with maximum acceleration in comparison with “normal” driving off. Use of Launch Control will inevitably reduce the life of the engaged engine and transmission components.

Preconditions:

- Launch Control should only be used when the engine has reached operating temperature.
- “Sport Plus” mode must be switched on (indicator light on the button comes on and “SPORT PLUS” appears on the multi-function display).

1. Press the brake with your left foot.
2. Quickly press the accelerator down fully (kickdown activated) and hold it. The engine speed will level off at around 5,000 rpm on the **Panamera S**, around 5,500 rpm on the **Panamera 4S**, around 4,550 rpm on the **Panamera Turbo**. “Launch Control active” appears on the multi-function display.
3. Release the brake within a few seconds. Remaining stationary for a long time with “Launch Control active” can lead to overloading of the transmission. To protect the transmission, the engine power is then reduced and the “Launch Control active” process is cancelled.

Shifting gears on the steering wheel

With the shift buttons on the steering wheel, you can change temporarily from automatic selection mode **D** to manual mode **M**.

For example:

- Shifting down before bends and on entering built-up areas.
- Shifting down on downward slopes (engine braking).
- Shifting down for brief spurts of acceleration.

The manual selection mode remains engaged:

- For cornering (depending on the lateral acceleration) and overrunning.
- When the vehicle is stationary (e.g. at a junction).

The system leaves manual selection mode:

- automatically after around 8 seconds (unless cornering or overrunning),
- after driving off.

Kickdown

The kickdown function is active in selector-lever positions **D** and **M**.

- ▷ For optimum acceleration, e.g. when overtaking, press the accelerator pedal beyond the full-throttle point (kickdown).

The transmission shifts down depending on the speed of travel and engine speed. Upshifts occur at the highest possible engine speeds.

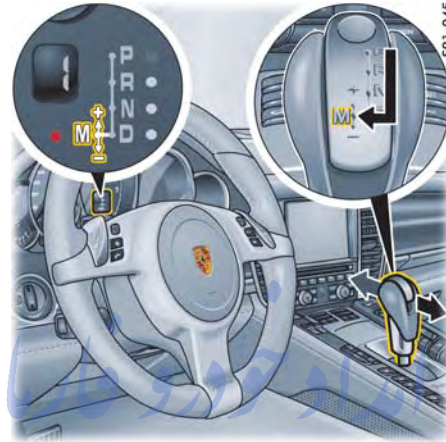

M – Manual selection mode

The currently engaged gear is retained when you change from **D** to **M**.

If you change from **M** to **D**, the gear-changing map suitable for your current driving style is selected and the appropriate gear is selected.

The selector lever and the two shift buttons in the upper steering-wheel spokes let you select the seven forward gears comfortably and reliably.



Shifting up +

- ▷ Press the PDK selector lever or shift button on the steering wheel forward.



Upshift prompt for fuel-economy-optimised driving

The consumption-oriented upshift indicator **A** in the tachometer at the right beside the digital speed display helps you to develop a fuel-saving driving style.

The upshift indicator lights up - prompting you to shift up to the next-higher gear - depending on the selected gear, engine speed and accelerator pedal position.

The upshift indicator is only active when "Sport" or "Sport Plus" mode is switched off.

- ▷ Change to the next-higher gear when the upshift indicator lights up.

Shifting down –

- ▷ Pull the PDK selector lever or shift button on the steering wheel back.

You can shift up or down by the corresponding number of gears by quickly pressing or pulling the shift buttons or selector lever several times in succession.

The transmission can be shifted up or down by several gears in succession by continuously operating the selector lever or shift buttons.

You can shift up or down at any time depending on driving speed and engine speed.

Gear changes that would exceed the upper or lower engine-speed limit are not executed by the control unit.

There is no automatic upshift at the upper engine-speed limit in selector-lever position **M**. Upshift suppression can be cancelled by kickdown operation. If, for example, the engine-speed limit is reached during overtaking and an automatic upshift does not occur, the transmission shifts up in this case as a result of kickdown operation.

- ▷ Select an appropriately low gear on upward and downward slopes.
This will ensure optimum use of engine power and engine braking.

To shift up automatically at the upper engine-speed limit:

- ▷ Press the accelerator pedal beyond the full-throttle point (kickdown).

Failure of the selector lever display on the instrument panel

The warning "Gearbox emergency operation" appears in red on the multi-function display.

Effect:

- No selector-lever position is displayed on the instrument panel.
Vehicle can be driven only until it comes to a stop.

Action required:

- ▷ It is not possible to continue driving. Stop the vehicle immediately in a suitable place. Have the vehicle towed to a qualified specialist workshop.
- ▷ Please see the chapter "TOWING" on page 316.

Stopping

- ▷ For a brief stop, e.g. at traffic lights, leave the selector lever in drive position and hold the vehicle with the brake pedal.
- ▷ Do not hold the vehicle on a slope using the accelerator. Use the brake pedal or the electric parking brake instead.
- ▷ Before leaving the vehicle, always apply the electric parking brake and move the selector lever to position **P**.

Parking

- ▷ Go easy on the accelerator!
- ▷ When parking or maneuvering in a small space, control the speed by careful use of the footbrake.

Driving in winter

In wintry road conditions, it is advisable to take steep inclines in manual mode. This prevents gear changes occurring that could cause wheel spin.

Tow-starting, towing

- ▷ Please see the chapter “TOWING” on page 316.

Reduced driving program

If there is a fault in the transmission

- Depending on priority, either the “Gearbox emergency operation” warning in yellow or red or the warning “Gearbox temperature too high” will appear on the multi-function display.

“Gearbox emergency operation” warning in **yellow**

Effects:

- Restricted gearshift comfort, reverse gear may not function.

Action required:

- ▷ Have the fault corrected immediately. Please contact a qualified specialist workshop. We recommend that you have an authorized Porsche dealer to do this work as they have trained workshop personnel and the necessary parts and tools.

“Gearbox emergency operation” warning in **red**

Effect:

- Vehicle can be driven only until it comes to a stop.

Action required:

- ▷ It is not possible to continue driving. Stop the vehicle immediately in a suitable place. Have the vehicle towed to a qualified specialist workshop.
- ▷ Please see the chapter “TOWING” on page 316.

Warning “Gearbox temperature too high”

– Effects:

“Warning jerks” can be felt when driving off and the engine power may be restricted.

Action required:

Do not hold the vehicle with the accelerator on a hill, for example. Hold the vehicle with the brake. Reduce engine load. Stop the vehicle in a suitable place if possible. Allow the engine to run in selector-lever position **P** or **N** until the warning disappears.

FarmaSOS.com

PDK selector lever emergency release

In the event of an electronics failure, the PDK selector lever can only be moved from selector-lever position **P** if an emergency release operation has already been performed.

Note

If a selector lever emergency release was performed, the vehicle must not be towed.

- ▷ Please see the chapter "TOWING" on page 316.
- ▷ Secure the vehicle to prevent it from rolling away.

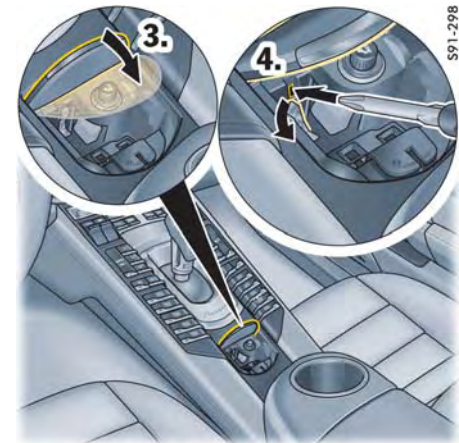
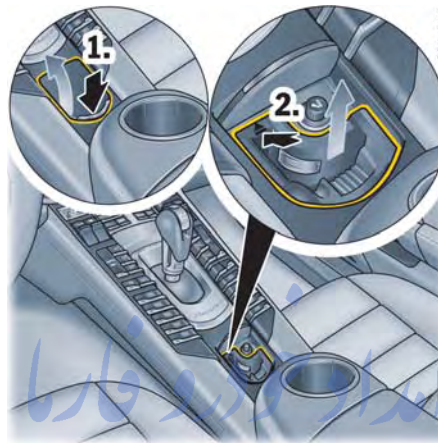

1. Open the ashtray.
 2. Remove the ashtray insert.
- ▷ Swivel the spring for locking the ashtray approx. 20° to the left.

FarmaSOS.com

3. Close the ashtray lid approx. 45° and hold it at that position.
4. Insert a screwdriver, for example, in through the opening, which is now visible at the right next to the spring, and press the release button for the selector support down.
5. Press the selector lever release button and move the selector lever out of position **P**. The vehicle can now be moved.
6. To secure the vehicle, move the selector lever to position **P**.

Transmission and Chassis Control Systems

Your Porsche features a complex integrated system made up of all control systems acting in power transmission and in the chassis. All control systems are networked with the aim of combining the best possible driving performance with maximum safety. The following systems are involved, depending on equipment:

System/designation	Scope
PTM Porsche Traction Management	<ul style="list-style-type: none">– Active all-wheel drive with electronically regulated map-controlled multiple-disc clutch
PSM Porsche Stability Management	<ul style="list-style-type: none">– Driving stability control– Anti-lock brake system (ABS)– Brake system prefilling– Brake booster (Hydraulic Brake Assist)– Automatic brake differential (ABD)– Anti-slip control (ASR)– Engine drag torque control (MSR)– HOLD function: standstill management
Air suspension with level control and height adjustment	<ul style="list-style-type: none">– Full load-bearing air-spring struts with integrated shock absorbers– Height adjustment with Low Level setting in “Sport Plus” mode and High Level setting for maneuvering
PASM Porsche Active Suspension Management	<ul style="list-style-type: none">– Shock absorber system with adaptive, continuous shock absorber control
PDCC Porsche Dynamic Chassis Control	<ul style="list-style-type: none">– Active chassis control system to stabilise roll tendency of vehicle body when driving– Controlled rear differential lock

Porsche Traction Management (PTM)

Porsche Traction Management is an active all-wheel control system designed to influence longitudinal and lateral dynamics. It is closely linked with the Porsche Stability Management (PSM) system.

The permanently driven rear axle enhances the vehicle's sporty features. Drive power is distributed fully variably to the front axle, depending on the driving situation. In conjunction with PSM, the PTM system ensures perfect distribution of power among all four wheels in every driving situation. This improves traction and driving stability and ensures the same high level of agility and dynamic response.

Warning!

In spite of the advantages of PTM and four-wheel drive, it is still the driver's responsibility to adapt his driving style and maneuvers in line with road and weather conditions, as well as the traffic situation.

The increased safety that is provided should not induce you to take greater risks with your safety. The limits set by the physics of driving cannot be overcome, even with PTM or four-wheel drive. Risk of accidents due to inappropriate speed cannot be reduced by PTM or four-wheel drive.

Advantages of PTM

- Clearly perceptible improvement in traction, driving stability and steering ability of the vehicle.
- Vehicle is more manageable when driven at its performance limits.
- Improved straight-ahead tracking and greater stability.
- More sporty vehicle setup while making full use of all the advantages of four-wheel drive.
- ASR and ABD further enhance traction for all wheels.

For information on ASR and ABD:

- ▷ Please see the chapter "PORSCHE STABILITY MANAGEMENT (PSM)" on page 202.

تلفن شبانه روزی: ۰۲۱-۸۸۶۲۰۸۵

FarmaSOS.com

Porsche Stability Management (PSM)

PSM is an active control system for stabilisation of the vehicle during extreme driving maneuvers. It operates together with the Porsche Traction Management (PTM) system provided the vehicle is fitted with the relevant equipment.

PSM makes use of both the ABD and ASR systems, as well as the known functions of the anti-lock brake system (ABS) and engine drag torque control system (MSR).

Warning!

In spite of the advantages of PSM, it is still the driver's responsibility to adapt his driving style and maneuvers in line with road and weather conditions, as well as the traffic situation.

The increased safety that is provided should not induce you to take greater risks with your safety. The limits set by the physics of driving cannot be overcome, even with PSM. Risk of accidents due to inappropriate speed cannot be reduced by PSM.

Advantages of PSM

- Best possible traction and lane-holding ability in all driving situations – even on road surfaces with varying friction.
- The system compensates for undesired vehicle reactions (Ferraria effect) when the driver releases the accelerator pedal or brakes on bends. This compensation functions up to the maximum lateral acceleration.
- PSM actively stabilises the vehicle if necessary during dynamic driving maneuvers (e.g. rapid steering movements, during lane changes, or on alternating bends).
- Improved braking stability on bends and on different or varying road surfaces.
- Improved brake function and shorter stopping distance in the event of emergency braking.

Readiness for operation

PSM is switched on automatically every time you start the engine.

Function

Sensors at the wheels, brakes, steering system and engine continuously measure:

- Speed
- Direction of travel (steering angle)
- Lateral acceleration
- Axial acceleration
- Rate of turn about the vertical axis

PSM uses these values to determine the direction of travel desired by the driver.

PSM intervenes and corrects the course if the actual direction of motion deviates from the desired course (steering-wheel position):
It brakes individual wheels as required.
If necessary, PSM also influences the engine power or the gear-changing characteristic of Porsche Doppelkupplung (PDK) in order to stabilise the vehicle.

The events below inform the driver of PSM control operations and warn him to adapt his driving style to the road conditions:

- PSM warning light on the instrument panel flashes.
- Hydraulic noises can be heard.
- The vehicle decelerates and steering-wheel forces are altered as PSM controls the brakes.
- Reduced engine power.
- The brake pedal pulsates and its position is changed during braking.
In order to achieve full vehicle deceleration, foot pressure must be increased after the brake pedal has begun vibrating.

Examples of PSM control operations

- If the “front wheels of the vehicle drift” on a bend, the engine power is reduced and the rear wheel on the inside of the bend is braked if necessary.
- If the rear of the vehicle swings out on a bend, the front wheel on the outside of the bend is braked.

- Brake system prefilling:
The brake system is prepared for possible subsequent emergency braking if the accelerator pedal is released suddenly and quickly. The brake system is prefilled and the brake pads are already applied gently to the brake discs.
- Brake booster (Hydraulic Brake Assist):
In the event of an emergency braking operation where the pedal force is insufficient, a brake booster provides the braking pressure necessary for maximum deceleration at all 4 wheels.

Combined operation of PSM and PTM

In order to ensure optimum stabilisation of the vehicle, torque distribution between the front and rear wheels is adapted and the rear differential lock is controlled on vehicles with PDCC.

In the event of a PTM fault, PSM cannot be switched off.

If PSM is switched off, it is switched on again automatically.

Automatic brake differential (ABD)

The ABD system controls the front and rear axles separately. If one wheel of an axle starts to spin, it is braked so that the other wheel on the same axle can be driven.

ABD recognizes different driving states, and it features control strategies adapted to these states. In situations in which little propulsive power is required, such as when the vehicle moves off on a level gravel surface, traction control already becomes active at low engine speeds. If a large amount of propulsive power is required, e.g. when driving off on an uphill slope or for rapid acceleration, the ABD system is adapted accordingly.

Anti-slip control (ASR)

The anti-slip control system prevents the wheels from spinning by adjusting the engine power, thereby ensuring good lane-holding ability and stable handling.

Engine drag torque control (MSR)

In conditions of excessive slip, the engine drag torque control system prevents all driven wheels from locking up when the vehicle is overrunning. This is also the case for downshifts on a slippery road.



Switching off PSM

- ▷ Press button  for at least 1 second. PSM is switched off after a short delay. The indicator light on the button and the PSM OFF warning light on the instrument panel light up. The warning “PSM off” appears on the multi-function display in the instrument panel.

When you brake in the ABS control range, the vehicle is stabilised even when PSM is switched off.

One-sided spinning of the wheels is prevented, even with PSM switched off.

PSM should always be switched on during “normal” driving.

However, it may be a good idea to switch off PSM temporarily in exceptional situations:

- On a loose surface and in deep snow.
- When “rocking the vehicle free”.
- When using snow chains.

Tip on driving

The vehicle retains its enhanced braking readiness through prefilling of the brake system even when PSM is switched off.

When PSM is switched off, wheel-specific brake interventions and the anti-slip control system (ASR) are also switched off.

The automatic brake differential (ABD) remains on.

Adaptive cruise control is deactivated when PSM is switched off.

When PSM is switched off, the slip monitoring function of Porsche Doppelkupplung (PDK) is also deactivated.

Switching PSM back on

- ▷ Press button . PSM is active immediately. The indicator light on the button and the PSM OFF warning light on the instrument panel go out. The message “PSM switched on” appears on the multi-function display in the instrument panel.

“Sport Plus” mode

A sportier setup is obtained when “Sport Plus” mode is switched on. PSM interventions occur later than in Normal mode. The vehicle can be maneuvered with greater agility at its performance limits, without having to dispense with the assistance of PSM in emergency situations. This helps to achieve optimal lap times, particularly on race circuits and on a dry road surface.

FarmaSOS.com

PSM warning light

- The PSM warning light on the instrument panel lights up for a lamp check when the ignition is switched on.
- The light indicates a control operation, even when PSM is switched off, e.g. brake control in the event of one-sided wheel spin.
- The light - in conjunction with the multi-function display - indicates a fault. The warning message “PSM failure” appears on the multi-function display in the instrument panel.

For information on warning messages on the multi-function display:

- ▷ Please see the chapter “OVERVIEW OF WARNING MESSAGES” on page 152.
- ▷ Adapt your driving style according to the changed conditions.
- ▷ Contact a qualified specialist workshop in order to correct the fault. We recommend that you have an authorized Porsche dealer to do this work, as they have the trained workshop personnel and the necessary parts and tools for this type of work.

Towing

For information on towing:

- ▷ Please see the chapter “TOWING” on page 316.

HOLD function: Drive-Off Assistant and standstill management

The HOLD function assists the driver when stopping and driving off on upward slopes. The vehicle is automatically prevented from rolling back away from the desired direction of travel. When the HOLD function is active, the function light **HOLD** on the instrument panel lights up.

When adaptive cruise control is operating normally, the HOLD function holds the vehicle following automatic braking until the vehicle is actively held in a stationary position.

Notes on operation

The HOLD function is not available if the PDK selector lever is in position **N**.

If the PDK selector lever is moved while the HOLD function is active, the HOLD function is deactivated.

If the driver's seat belt is unbuckled and the driver's door is opened while the HOLD function is active, the electric parking brake is activated automatically.

For information on the electric parking brake:

- ▷ Please see the chapter "ELECTRIC PARKING BRAKE" on page 171.

Warning!

In spite of the advantages of the HOLD function, it is still the driver's responsibility to adapt his driving style and maneuvers in line with road and weather conditions, as well as the traffic situation.

The increased safety that is provided should not induce you to take greater risks with your safety.

Caution!

If the vehicle comes to a stop on a steep uphill gradient without operation of the footbrake by the driver, this may result in a certain roll-back before the vehicle is held by the HOLD function. In this situation, the roll-back can be reduced by operating the footbrake.

- ▷ Assist holding of the vehicle by increasing the brake force with the footbrake.

Brake pedal feels different. When adaptive cruise control is operating normally or when the HOLD function is active, the brake pedal may feel different and you may hear hydraulic noises.

This behavior is normal for the system. It is not a fault.

Danger!

Risk of accidents. The limits set by physics of driving cannot be overcome, even with HOLD function. The responsibility for stopping and driving off on uphill gradients is still the driver's, despite the HOLD function. Assistance by the HOLD function is not always guaranteed when stopping and driving off on a slippery surface (e.g. on icy or loose surfaces). In this case, the vehicle can slip.

- ▷ Always adjust your driving style to the driving conditions and vehicle load. Use the footbrake if necessary.

If the Drive-Off Assistant is not functioning, the driver cannot be assisted when driving off on hills.

- ▷ Hold the vehicle with the footbrake.

ABS Brake System (Anti-Lock Brake System)



Warning!

In spite of the advantages of ABS, it is still the driver's responsibility to adapt his driving style and maneuvers in line with road and weather conditions, as well as the traffic situation.

The increased safety that is provided should not induce you to take greater risks with your safety. The limits set by the physics of driving cannot be overcome, even with ABS. Risk of accidents due to inappropriate speed cannot be reduced by ABS.

ABS ensures

- **Full steering control**
The vehicle remains steerable
- **Good driving stability**
No skidding due to locked wheels
- **Optimum braking distance**
Shorter stopping distance in most cases
- **Prevention of wheel locking**
No flat spots on the tires

Function

The decisive advantage of ABS lies in the driving stability and maneuverability of the vehicle in hazardous situations.

ABS prevents locking of the wheels during full braking, on almost all road surfaces, until just before the vehicle stops.

ABS begins to control the braking process as soon as a wheel shows a tendency to lock. This controlled braking process is comparable with extremely rapid cadence braking. The pulsating brake pedal and a "juddering noise" warn the driver to adapt his driving speed to the road conditions.

- ▷ If full braking is necessary, press the brake pedal fully during the whole braking operation, even though the pedal is pulsating. Do not reduce brake pressure.

ABS Warning light USA



Warning light Canada

If the ABS warning light lights up on the instrument panel while the engine is running, the ABS has switched off because of a fault.

The warning message "ABS failure" appears on the multi-function display in the instrument panel.

For information on warning messages on the multi-function display:

- ▷ Please see the chapter "OVERVIEW OF WARNING MESSAGES" on page 152.

In this case, the brake system will operate **without lock prevention**, as on vehicles without ABS.

- ▷ Adapt your driving style to the changed braking behavior.
The ABS must be checked by your authorized Porsche dealer in order to prevent the occurrence of further faults with unpredictable consequences.
Please contact a qualified specialist workshop. We recommend that you have an authorized Porsche dealer to do this work as they have trained workshop personnel and the necessary parts and tools.

The ABS control unit is adjusted for the approved tire dimensions.

The use of tires with non-approved dimensions can lead to different wheel speeds, causing ABS to switch off.

FarmaSOS.com

Porsche Active Suspension Management (PASM)

The PASM system actively adjusts the shock absorbers. The adjustable damper system selects the appropriate damping level for each wheel according to the driving situation and driving conditions. Driving safety, agility and comfort are optimised.

Three different chassis setups can be selected at the push of a button:

- “PASM Comfort”
- “PASM Sport”
- “PASM Sport Plus”

Comfort mode ensures comfortable chassis tuning.

The “PASM Sport” chassis setup offers very sporty shock absorber tuning.

“PASM Sport Plus” mode offers particularly sporty shock absorber tuning (e.g. for driving on the race circuit).

In addition to manual mode selection, PASM also adjusts shock absorber tuning for either sporty or comfort driving, depending on the driving situation.



Selecting the PASM mode

1. Switch on ignition.
2. Press button  (repeatedly).

On the button:

- No indicator light comes on when you select “PASM Comfort” (default setting).
- One indicator light comes on when you select “PASM Sport”.
- Two indicator lights come on when you select “PASM Sport Plus”.

In addition, the selected chassis setup is shown on the multi-function display in the instrument panel for approx. 4 seconds.

Note on operation

The last selected chassis setup is stored in the memory after the ignition is switched off.

Warning message

The system automatically detects PASM faults and displays them on the multi-function display in the instrument panel.

For information on warning messages on the multi-function display:

- ▷ Please see the chapter “OVERVIEW OF WARNING MESSAGES” on page 152.
- ▷ Adapt your driving style according to the changed conditions.
- ▷ Contact a qualified specialist workshop in order to correct the fault. We recommend that you have an authorized Porsche dealer to do this work, as they have the trained workshop personnel and the necessary parts and tools for this type of work.

Porsche Active Suspension Management (PASM) with Air Suspension and Level Control

PASM with air suspension is an active shock absorber adjustment and ride height balancing system. The adjustable damper system selects the appropriate damping level for each wheel according to the driving situation and driving conditions. The level control system automatically balances load changes and maintains a constant ride height. Driving safety, agility and comfort are optimised.

Three different chassis setups can be selected at the push of a button:

- “PASM Comfort”
- “PASM Sport”
- “PASM Sport Plus”

Comfort mode ensures comfortable chassis tuning.

The “PASM Sport” chassis setup offers very sporty shock absorber tuning.

“PASM Sport Plus” mode offers particularly sporty shock absorber tuning (e.g. for driving on the race circuit). The vehicle is also lowered by approx. 1 in. (25 mm) compared with the normal level and the spring rate is increased.

In addition to manual mode selection, PASM also adjusts shock absorber tuning for either sporty or comfort driving, depending on the driving situation.



Selecting the PASM mode

1. Switch on ignition.
2. Start the engine.
3. Press button  (repeatedly).

On the button:

- No indicator light comes on when you select “PASM Comfort” (default setting).
- One indicator light comes on when you select “PASM Sport”.
- Two indicator lights come on when you select “PASM Sport Plus”.

In addition, the selected chassis setup is shown on the multi-function display in the instrument panel for approx. 4 seconds.

Note

The mode cannot be changed if a door or the tailgate is opened or when the engine is switched off.

When the vehicle is stopped, the ride height may be adjusted automatically in order to balance the vehicle load.

High Level

The level control system allows you to raise the vehicle in maneuvering mode by approx. 0.8 in. (20 mm) compared with the normal level in order to drive over curbs and ramps.

High Level can only be selected manually and at speeds of less than approx. 20 mph (30 km/h).

Note

High Level must not be used on public roads since the prescribed installation height of the reflectors can be exceeded in High Level.



Selecting High Level

1. Switch on ignition.
2. Start the engine.
3. Press button .

When High Level is selected, the indicator light on the button lights up.
The message “High Level selected” appears on the multi-function display.

Note on operation

The last selected level is stored in the memory after the ignition is switched off. The level control system automatically switches from High Level at a speed of approx. 20 mph (30 km/h).

Switching level control on and off

Automatic level control must be switched off when driving onto a lifting platform or when raising one wheel.

For information on jacking up the vehicle:

- ▷ Please see the chapter “RAISING VEHICLES WITH A LEVEL CONTROL SYSTEM” on page 290.

Switching off level control

1. Switch on ignition.
2. Press and hold button  for approximately 10 seconds.
The message “Control off” appears on the multi-function display in the instrument panel.

Note

Level control can only be switched off when the vehicle is stationary.

Switching on level control

1. Lower the vehicle.
2. Switch on ignition.
3. Press and hold button  for approximately 10 seconds.
The message “Control on” appears on the multi-function display in the instrument panel.

Notes

Level control is switched on automatically at a speed of more than approx. 4 mph (7 km/h).

Warning message

The system automatically detects PASM faults and displays them on the multi-function display in the instrument panel.

For information on warning messages on the multi-function display:

- ▷ Please see the chapter “OVERVIEW OF WARNING MESSAGES” on page 152.
- ▷ Adapt your driving style according to the changed conditions.
- ▷ Contact a qualified specialist workshop in order to correct the fault. We recommend that you have an authorized Porsche dealer to do this work, as they have the trained workshop personnel and the necessary parts and tools for this type of work.

Note

If vehicles with air suspension are left stationary for several weeks, the ride height can be reduced. The vehicle automatically re-adjusts to the correct ride height when you start the engine. This can take several minutes, depending on the operating state. Ground clearance is reduced at this time.

Porsche Dynamic Chassis Control (PDCC)

Function

The Porsche Dynamic Chassis Control (PDCC) system used on vehicles with air suspension is a system for roll stabilisation of the vehicle body when driving.

Driving comfort and driving safety are improved by active intervention of the anti-roll bars on the front and rear axles. Vehicle balance and agility are optimised.

No separate controls are available for the PDCC system.

When you select a chassis setup in Porsche Active Suspension Management (PASM) with air suspension and level control, the PDCC system automatically activates the corresponding on-road driving program.

For information on selecting a chassis setup:

- ▷ Please see the chapter “PORSCHE ACTIVE SUSPENSION MANAGEMENT (PASM) WITH AIR SUSPENSION AND LEVEL CONTROL” on page 209.

Warning message

The warning message “Fault PDCC” or “PDCC failure” appears on the multi-function display in the instrument panel if there is a system fault.

For information on warning messages on the multi-function display:

- ▷ Please see the chapter “OVERVIEW OF WARNING MESSAGES” on page 152.
- ▷ Adapt your driving style according to the changed conditions.
- ▷ Contact a qualified specialist workshop in order to correct the fault. We recommend that you have an authorized Porsche dealer to do this work, as they have the trained workshop personnel and the necessary parts and tools for this type of work.

تلفن شبانه روزی: ۰۲۱-۸۸۸۶۲۰۸۵

FarmaSOS.com

Checking hydraulic fluid

The hydraulic fluid is checked and changed regularly as part of servicing.

For information on maintenance:

- ▷ Please see the chapter “EXERCISE EXTREME CAUTION WHEN WORKING ON YOUR VEHICLE” on page 252.

“Sport” and “Sport Plus” Mode

Function

The selectable chassis settings mean that the vehicle can offer various modes for a sportier overall setup.

When “Sport” or “Sport Plus” mode is selected, all the vehicle’s control systems are intentionally shifted towards greater agility and driving performance:

- PASM (Porsche Active Suspension Management) is automatically changed to “PASM Sport” or “PASM Sport Plus” mode, resulting in a stiffer suspension setup. The vehicle switches to Low Level in “PASM Sport Plus” mode.
- ▷ Please see the chapter “PORSCHE ACTIVE SUSPENSION MANAGEMENT (PASM)” on page 208.
- Just like PASM, PDCC is switched to the corresponding “Sport” or “Sport Plus” mode, whereby the rolling movements of the vehicle are reduced further, depending on the selected mode.
- ▷ Please see the chapter “PORSCHE DYNAMIC CHASSIS CONTROL (PDCC)” on page 211.
- The PDK transmission switches to a sporty gear-changing map and shortens the gear shifting times when Sport mode is activated. Gear changes take place faster.
- ▷ Please see the chapter ““SPORT” AND “SPORT PLUS” MODE” on page 195.
- The electronic accelerator pedal reacts sooner, and the engine is more responsive to throttle inputs. When Sport mode is switched on and the vehicle is travelling at a speed of less than 25 mph (40 km/h), this function is activated only after the driver has floored the accelerator pedal or released it briefly.
- The rpm limiter characteristic is “harder”. In other words: the engine is immediately throttled when the performance limits are reached (only in manual selection mode on vehicles with PDK).
- The turbo overboost briefly increases the engine boost pressure in the engine speed range from 2,500 rpm to approx. 4,000 rpm. As a result, torque in this speed range is increased by 70 Nm (52 ftlb.). This considerably improves acceleration and flexibility, particularly in the medium engine speed range. This does not affect the maximum power. Quickly flooring the accelerator pedal activates turbo overboost in the engine control system. Overboost has an effective operating time of approx. 10 seconds. After this time, it can be re-activated by quickly flooring the accelerator pedal again.
- PSM (Porsche Stability Management) control is more sporty in “Sport Plus” mode. PSM interventions are later than in Normal mode. The driver can maneuver the vehicle with greater agility at its performance limits, without having to dispense with the assistance of PSM in emergency situations. This helps to achieve optimal lap times, particularly on race circuits with a dry road surface.
- ▷ Please see the chapter “PORSCHE STABILITY MANAGEMENT (PSM)” on page 202.
- Adaptive cruise control regulates speed and distance more dynamically.
- The Auto Start Stop function is deactivated.
- ▷ Please see the chapter “AUTO START STOP FUNCTION” on page 169.
- The rear spoiler extends earlier and retracts later (“Sport Plus” mode only).
- ▷ Please see the chapter “RETRACTABLE REAR SPOILER” on page 214.
- The system switches from High Level.
- ▷ Please see the chapter “HIGH LEVEL” on page 209.



Switching “Sport” mode on and off

- ▷ Press button **SPORT**.
When “Sport” mode is switched on, the indicator light on the button lights up. The word “SPORT” appears on the digital speedometer.

A sporty gear-changing map is enabled and the gear shifting times are shorter for the PDK transmission.
A sporty driving style is recognized more quickly and the gear-changing speeds are adapted to driving performance.
Braking downshifts are initiated earlier. Downshifts occur for small decelerations, even at higher revs.



Switching “Sport Plus” mode on and off

- ▷ Press button **SPORT PLUS**.
When “Sport Plus” mode is switched on, the indicator light on the button lights up. The words “SPORT PLUS” appear on the digital speedometer.

In “Sport Plus” mode, the PDK transmission changes to a shift program designed for driving on race circuits. 7th gear is not selected. The gear-changing performance is enhanced significantly again compared with Sport mode.
The turbo overboost function (brief torque increase at full throttle) is activated on vehicles with the Sport Chrono Turbo package.

“Sport”/“Sport Plus” and “PASM Sport”/“PASM Sport Plus” mode

Switching “Sport” or “Sport Plus” mode on and off simultaneously activates and deactivates the corresponding PASM mode (“PASM Sport” or “PASM Sport Plus”).

The PASM mode can be switched manually if you want to use the characteristics of “Sport” or “Sport Plus” mode, but prefer a more comfortable chassis setup.

- ▷ Press button  (repeatedly).
The indicator light for the selected chassis setup on the button lights up. In addition, the selected chassis setup is shown on the multi-function display in the instrument panel for approx. 4 seconds.

For information on PASM:

- ▷ Please see the chapter “PORSCHE ACTIVE SUSPENSION MANAGEMENT (PASM)” on page 208.

Warning messages

The warning message “Sport mode error” appears on the multi-function display in the instrument panel in the event of a fault.

For information on warning messages on the multi-function display:

- ▷ Please see the chapter “OVERVIEW OF WARNING MESSAGES” on page 152.

Note

After the ignition is switched off, Sport mode is automatically reset to Normal mode.

- ▷ Please see the chapter “PORSCHE ACTIVE SUSPENSION MANAGEMENT (PASM)” on page 208.
- ▷ Please see the chapter “PORSCHE DYNAMIC CHASSIS CONTROL (PDCC)” on page 211.

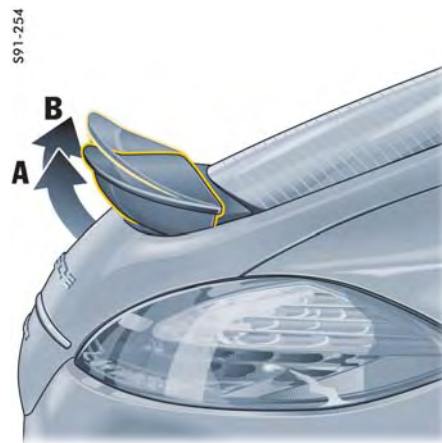

Sports Exhaust System

Switching on and off

The sports exhaust system can be switched to a sound-optimised mode when the ignition is switched on.

- ▷ Press button . When the sports exhaust system is switched on, the indicator light on the button lights up.

Retractable Rear Spoiler

The rear spoiler improves driving stability at high speeds and reduces fuel consumption at low speeds.

Vehicles with a turbo engine have an enhanced rear spoiler with a larger aerodynamically effective spoiler surface thanks to additional flaps.



Automatic mode

Automatic extension and retraction of the rear spoiler depends on various conditions.

Extending the rear spoiler manually

- ▷ Press button  briefly.
The rear spoiler extends to position **A**.
The indicator light on the button lights up.
The rear spoiler is in manual mode.

Retracting a manually extended rear spoiler

- ▷ **when the vehicle is stationary**
Press and hold button  until the rear spoiler has reached its end position.
The indicator light on the button goes out.
The rear spoiler is in automatic mode.
- ▷ **at speeds of up to approx. 55 mph (90 km/h)**
Press button .
The rear spoiler retracts and the indicator light on the button goes out.
The rear spoiler is in automatic mode.
- ▷ **at speeds of more than approx. 55 mph (90 km/h)**
Press button .
The rear spoiler remains extended and the indicator light on the button goes out.
The rear spoiler is in automatic mode.

“Sport Plus” mode deactivated

The rear spoiler extends automatically from position **A** to position **B** at approx. 130 mph (205 km/h).

The rear spoiler retracts automatically from position **B** to position **A** at approx. 110 mph (180 km/h).

“Sport Plus” mode activated

The rear spoiler extends automatically from position **A** to position **B** at approx. 55 mph (90 km/h).

The rear spoiler retracts automatically from position **B** to position **A** at approx. 40 mph (60 km/h).

Warning!

Risk of injury during manual retraction or extension of the rear spoiler when the vehicle is stationary.

- ▷ Make sure that no persons or objects are within the range of movement of the rear spoiler.

Risk of damage from pushing the vehicle by the spoiler.

- ▷ Do not push the vehicle at the rear spoiler.

تلفن شبانه روزی: ۰۲۱-۸۸۸۶۲۰۸۵

FarmaSOS.com

Storage, Luggage Compartment and Roof Transport System

Storage	218
Drinks Holder/Cupholder	221
Front Ashtray	224
Rear Ashtray	224
Cigarette Lighter	225
Refrigerated box in the rear of the vehicle	226
Folding Rear Seats Forward and Returning to Upright Position	226
Luggage Compartment.....	227
Stowing Loads	228
Luggage Compartment Cover	229
Fixed Luggage Compartment Cover.....	231
Ski Bag	231
Roof Transport System.....	232
Loading Information.....	236

امداد خودرو فارما

تلفن شبانه روزی: ۰۲۱-۸۸۸۶۲۰۸۵

FarmaSOS.com

Storage

Warning!

Risk of injury during braking, rapid direction changes or in an accident.

- ▷ Do not transport items of luggage or objects unsecured in the passenger compartment.
- ▷ Do not transport any heavy objects in open storage trays.
- ▷ Always keep the covers of the storage trays closed while driving.
- ▷ Always protect the passenger compartment with a luggage compartment cover.

Note on operation

An unsecured or incorrectly positioned load can slip out of place or endanger the vehicle occupants during braking, direction changes or in accidents.

For information on stowing loads and luggage:

- ▷ Please see the chapter "STOWING LOADS" on page 228.

Storage options

There are various storage options available, depending on the vehicle equipment:

- Glove box with pen and paper holder.
- In the front and rear armrests.
- In the door panels.
- In the center console, front and rear.
- On the back of the front seat backrests.
- Clothes hooks on the rear grab handles.
- Under the luggage compartment floor.
- In the front and rear cupholders.



Glove box

Warning!

Risk of injury by the glove box lid in case of an accident.

- ▷ Keep the glove box closed while driving.

The glove box contains a drawer for storing the vehicle folder and a holder for clipping in a pen.

تلفن شبانه روزی: ۰۲۱-۸۸۸۶۲۰۸۵

FarmaSOS.com

Opening

- ▷ Pull the latch handle and open the lid.

Closing

- ▷ Always lock the latch handle with the emergency key to secure the contents from unauthorized access.



Cooled glove box

The glove box can be cooled if necessary. Cooled air is directed into the glove box via a separate air vent.

For information on cooling the glove box:

- ▷ Please see the chapter "COOLED GLOVE BOX" on page 83.



Storage tray in the armrest between the front seats

Opening

- ▷ Press the button (**arrow**) on the passenger's side of the armrest. The lid pops up automatically.



Storage tray in the rear center console

Opening

- ▷ Slide the lid sideways to the left or right at the handle recess.



Storage tray in the rear armrest

An storage tray is located in the armrest. تلفن شماره ۰۲۱-۸۸۶۷۸۸

Opening the storage tray in the armrest

1. Fold armrest down fully.
2. Press the button (**arrow**) and lift the lid.



Lower storage compartment in the large center console

Storage trays in the large center console in the rear of the vehicle

Opening lower storage compartment

- ▷ Press the release button and lift the lid.



Upper storage compartment in the large center console

Opening upper storage compartment

- ▷ Press the release button (**arrow**) and fold down the lid.

Note on operation

The shelf in the upper storage compartment can be folded upwards to increase the storage space.

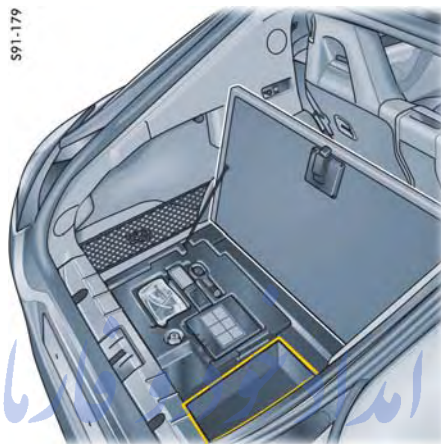

Storage compartment under the luggage compartment floor

There is additional storage space under the luggage compartment floor, depending on the vehicle equipment.

Lifting the luggage compartment floor

- ▷ Pull the luggage compartment floor at the handle recess and lift it up.

For information on the luggage compartment:

- ▷ Please see the chapter "STOWING LOADS" on page 228.



Drinks Holder/Cupholder

You can place drinks in the cupholder.

Warning!

Risk of scalding and damage due to spilling drinks.

- ▷ Only use cupholder when safe to do so.
- ▷ Only use containers that fit.
- ▷ Never put overfull containers in the cupholder.
- ▷ Do not use with hot drinks.



Opening the front cupholder

Note

- ▷ Keep the cupholder above the glove box closed while driving.
1. Press the cupholder panel.
The panel opens.



2. Press the symbol for the required cupholder.
3. Close the panel in the middle.

The cupholders can be adjusted to fit larger containers.

FarmaSOS.com



Pulling cupholder out

1. Pull out the holder (**arrow**).
2. Insert a cup/container.
3. Carefully slide the holder inwards to adjust it to the size of the cup/container.

Folding cupholder in

1. Push cupholder drawer in.
2. Open the panel in the middle.
3. Fold the cupholder in and engage it.
4. Close the panel in the middle.



Opening the rear cupholder

Cupholder between the seats

A cupholder is located in the storage tray in the center console between the rear seats.

- ▷ Slide the lid sideways to the left or right at the handle recess.
- ▷ Fold up the additional cupholder support to accommodate large cups/containers.



Cupholder in the center console

Another cupholder is located under the cover flap in the front of the rear center console.

- ▷ Press briefly on the cupholder lid. The lid opens automatically.



Cupholder in the large center console in the rear of the vehicle

A cupholder is located at the front of the large center console or at the rear if the relevant vehicle equipment is fitted.

- ▷ Press briefly on the cupholder lid. The lid opens automatically.

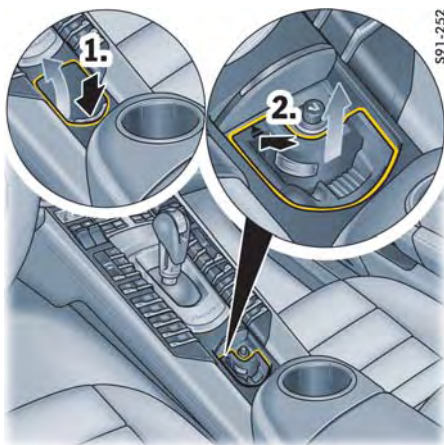

S91-252

Emptying

2. Press the front ashtray insert forward slightly. The ashtray insert snaps out and can be removed.
- ▷ After emptying the ashtray, replace the insert and push it down until it clicks into place.

امداد خودرو فارما

تلفن شبانه روزی: ۰۲۱-۸۸۸۶۲۰۸۵

FarmaSOS.com

Front Ashtray



Danger of fire.

- ▷ Never use ashtray for waste paper disposal as it could pose a fire hazard.

Opening

1. Press briefly on the ashtray lid. The lid opens automatically.



S91-116

Rear Ashtray



Danger of fire.

- ▷ Never use ashtray for waste paper disposal as it could pose a fire hazard.

Opening ashtrays in the doors

- ▷ Press briefly on the ashtray lid.

Emptying ashtrays in the doors

1. Open the ashtray lid and carefully press it up. The insert pops up slightly.
2. Remove the insert and empty it.



Front cigarette lighter



Rear cigarette lighter

Cigarette Lighter



Warning!

Danger of fire and burning. The cigarette lighter is ready for use regardless of the ignition lock position

- ▷ Do not leave children in the vehicle unattended.
- ▷ Never touch the heating element or sides of the lighter.
- ▷ Only hold the heated lighter by the knob.

Using front and rear cigarette lighters

- ▷ Press briefly on the ashtray lid in the front center console or slide the ashtray lid in the rear center console sideways to the left or right at the handle recess.
- 3. Press the lighter into the receptacle. When the element is red hot, the lighter will jump back to its initial position.



Refrigerated box in the rear of the vehicle

The refrigerated box in the rear of the vehicle consists of a compressor-operated refrigerated box between the rear seats.

For information on the refrigerated box:

- ▷ Please see the separate operating instructions for the refrigerated box.

Opening the refrigerated box

- ▷ Press the button (**arrow**) on the refrigerated box lid and fold down the lid.



Folding Rear Seats Forward and Returning to Upright Position

The rear seats are divided and can be folded forward individually to make the luggage compartment bigger.

The pass-through facility between the rear seats can also be folded forward, depending on the vehicle equipment.

Folding rear seats forward

On vehicles with automatically controlled four-zone air conditioning:

- ▷ Press the safety button  in the driver's door armrest before folding the rear seats forward. The indicator light on the button lights up. The control panel on the rear center console and the power window buttons on the rear doors will not function. Pressing the buttons unintentionally will not change any settings.

1. Move front seats forward.
2. Press the release handle **A** on the seat backrest and fold the backrest forward.

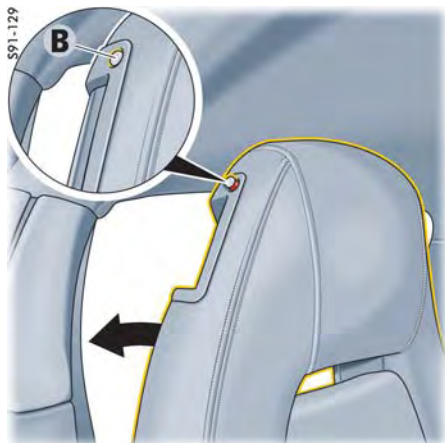

Adjusting rear seats to vertical position

- ▷ Make sure that the seat belts are not trapped. Fold up the backrest until it locks with an audible click. The red control stud **B** must be lowered completely.



Warning!

Risk of injury. The rear seat back rest must be kept locked when driving. When you brake or in the event of an accident, objects can slide into the passenger compartment and endanger the occupants.

- ▷ Always lock rear-seat backrests securely.

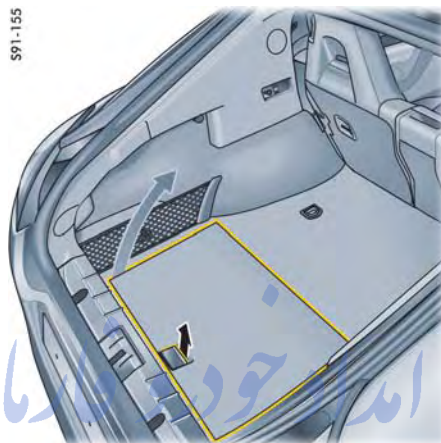

Luggage Compartment

The maximum permissible load on the loadspace floor in the luggage compartment is 200 kg. The weight must be distributed evenly over the entire luggage compartment floor.

For information on stowing loads and luggage:

- ▷ Please see the chapter "STOWING LOADS" on page 228.

Opening/closing the luggage compartment floor

- ▷ Fold the luggage compartment floor up or down using the handle (**arrow**).



Tie-down rings

The load can be secured in the luggage compartment to prevent it from slipping by fastening tie-down straps to the tie-down rings.

- ▷ Make sure that all rings are equally loaded when securing a load.

Note on operation

The tie-down rings are not designed to restrain a heavy load in an accident.

Stowing Loads



Danger!

Danger of injury. An unsecured or incorrectly positioned load can slip out of place or endanger the vehicle occupants during braking, direction changes or in accidents. Never transport objects that are not secured.

- ▷ Always transport loads in the luggage compartment, never in the passenger compartment (e.g. on or in front of the seats).
- ▷ Support the load against the seat backrests wherever possible. Always lock the backrests into place.
- ▷ Only transport heavy objects with the rear seat backrests upright and engaged.
- ▷ Place the load behind unoccupied seats whenever possible.
- ▷ Stow heavy objects as far forward as possible on the floor, with lightweight objects behind them.
- ▷ Never load the vehicle higher than the top edge of the seat backrest.
- ▷ Always protect the passenger compartment with a luggage compartment cover. Do not drive with objects on top of the luggage compartment cover.

- ▷ If the rear seats are not occupied, the backrests can be additionally secured with the seat belts. Simply cross the outer seat belts and insert each into the opposite buckle.
- ▷ Make sure that the load cannot damage the heating filaments and the TV antenna in the rear window.

Tie-down belts

- ▷ Do not use elastic belts or straps to tie down a load.
- ▷ Do not route belts and straps over sharp edges.
- ▷ Observe the directions for use and information for the tie-down equipment.
- ▷ Use only belts with a tear strength of at least 1543 lbs (700 kg) and a maximum width of 1 in. (25 mm).
- ▷ Cross the belts over the load.

FarmaSOS.com

Driving

- ▷ Vehicle handling changes depending on the vehicle load. Adapt your driving style to the changed driving behavior.
- ▷ Do not exceed the maximum gross weight and axle load.

This information can be found under “Technical data” in this Owner’s Manual:

- ▷ Please see the chapter “WEIGHTS” on page 328.
- ▷ Never drive with the tailgate open. Exhaust gases can enter the passenger compartment.
- ▷ Adapt the tire pressure to the load. After you change the tire pressure, you must also update the setting for Tire Pressure Monitoring.

For information on setting Tire Pressure Monitoring on the multi-function display:

- ▷ Please see the chapter “OVERVIEW OF WARNING MESSAGES” on page 152.

Information on tire pressures for partially and fully loaded vehicles can be found under “Technical data” in this Owner’s Manual:

- ▷ Please see the chapter “TIRE PRESSURE FOR COLD TIRES (68 °F/20 °C)” on page 326.

Luggage Compartment Cover



Warning!

Risk of injury. In the event of braking, direction changes or in an accident, objects can slide into the passenger compartment and endanger the occupants.

- Do not place objects on the retractable luggage compartment cover or on the fixed luggage compartment cover.

Retractable luggage compartment cover

Luggage can be protected against prying eyes with the retractable luggage compartment cover.

- Always pull out the retractable luggage compartment cover when transporting objects in the luggage compartment. The retractable luggage compartment cover is not designed to carry objects.



Pulling out retractable luggage compartment cover

- Pull out the retractable cover.
- Engage the cover on the tailgate at the left.
- Pull the cover to the right using the grab handles and engage it. The retractable cover will center itself.

Retracting retractable luggage compartment cover

- Disengage the retractable luggage compartment cover from the guides on the tailgate and carefully guide it back into the retractor roller.

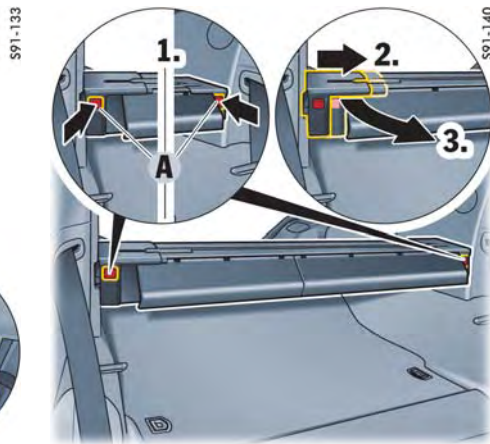

Removing retractable luggage compartment cover with fold-away rear roller blind

- Fold rear seat backrests forward.
 - Press both release buttons **A**. The buttons can be reached from the passenger compartment.
 - Slide the movable end cap on the right side of the vehicle inwards.
 - Remove the retractable cover holder by moving it towards the passenger compartment.



Installing retractable luggage compartment cover with fold-away rear roller blind

- ▷ Fold rear seat backrests forward.
- 1. Insert the retractable cover holder from the passenger compartment on the left side of the vehicle into the mounting point.
- 2. Slide the movable end cap inwards and insert it into the mounting point at the left. The end caps will move out automatically.

The release buttons **A** must pop out perceptibly with an audible click.

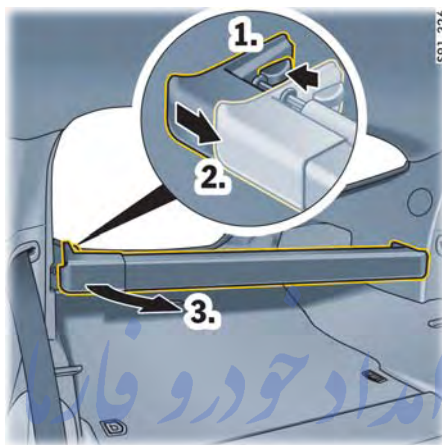

Removing retractable luggage compartment cover without fold-away rear roller blind

- ▷ Fold rear seat backrests forward.
- 1. Press the release button.
- 2. Slide the end cap inwards.
- 3. Remove the retractable cover holder by moving it towards the passenger compartment.

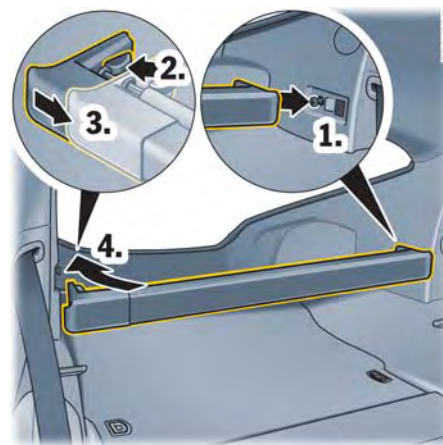

Installing retractable luggage compartment cover without fold-away rear roller blind

- 1. Insert the retractable cover holder into the mounting point at the right from the rear seat.
- 2. Make sure that the release button is pressed.
- 3. Slide the end cap inwards.
- 4. Insert the retractable cover holder at the left and let the end cap go. The release button engages automatically.

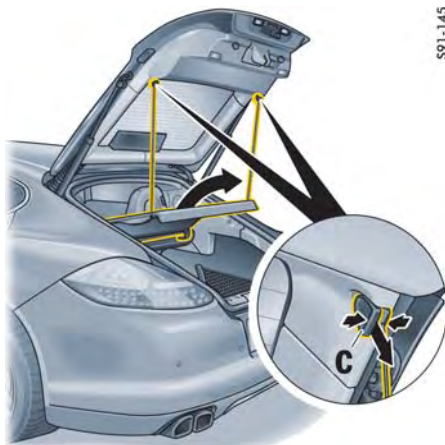

S91-145

Fixed Luggage Compartment Cover

The fixed luggage compartment cover is a movable fixture engaged behind the rear seats at the left and right. It can be disengaged and removed as required.

Disengaging fixed luggage compartment cover at the tailgate

- ▷ Press fixing clips **C** together in the tailgate and pull them out in a downward direction.



S91-279

Ski Bag

Skis can be transported safely and without damaging the passenger compartment using the ski bag.

Notes

- ▷ Read the packaging and fitting instructions on the ski bag.
- ▷ Fold up the ski bag only when it is dry.

Using the ski bag

1. Pack one to max. two pairs of skis (max. 17 kg) in the ski bag with the tips of the skis facing forward. The zipper must be facing the rear of the vehicle.
2. Close the zipper on the ski bag.
3. Tighten the closing belt on the ski bag securely. Make sure that the closing belt goes all the way around the skis ahead of where the skis are secured in direction of travel.
4. Pass the ski bag through between the rear seats or fold the right seat backrest forward.
5. Place the ski bag in the middle of the luggage compartment with the tips of the skis facing forward in direction of travel. The zip is facing backwards.
6. Hook the spring hooks on the side tension straps on the ski bag into the tie-down rings at the left and right.
7. Tighten the side tension straps on the ski bag securely at the left and right.

Stowing the ski bag

- ▷ Pack the ski bag into the gear bag and stow it behind the luggage net at the left or right of the luggage compartment.

Roof Transport System

A roof transport system can be fitted on the vehicle for transporting awkward objects. Various objects can be transported safely and securely using the roof transport system and additional attachments, e.g. ski rack, bicycle rack, surfboard rack, roof box or snowboard holder.

- ▷ Only use roof transport systems that have been tested and approved by Porsche. It is **not** possible to fit commercially available roof rack systems.

Danger!

Risk of accidents if the vehicle loses its roof transport system due to excessive speed or improper loading.

- ▷ Check the roof transport system and attachments before every journey and at regular intervals during a long journey to ensure that they are fitted correctly and securely. Tighten all fastening screws again.
- ▷ Adjust your driving style accordingly by maintaining a reasonable speed and slowing hour vehicle turns.
- ▷ Do not drive at a speed of more than 80 mph (130 km/h) when the roof transport system is fitted and loaded.
- ▷ Do not drive at a speed of more than 110 mph (180 km/h) when the roof transport system is fitted but not loaded. Obey all traffic laws. تلفن شبانه روزی: ۰۸۵-۸۸۶۲۰۸۸۵
- ▷ Load the roof transport system so that the load does not protrude over the sides of the roof transport system. www.porsche.com
Never load the roof transport system wider than the width of the vehicle.
- ▷ Position the center of gravity of the load as low as possible with respect to the roof transport system and distribute the load evenly over the load area.
- ▷ Secure the load so that it will not move during the journey.
Do not use elastic rubber tensioners.

Caution!

Washing the vehicle in a car wash or failure to observe the overall vehicle height or the maximum permitted gross weight can damage the vehicle or roof transport system.

- ▷ Remove the complete roof transport system before washing the vehicle in a car wash.
- ▷ Check the overall vehicle height with the roof transport system fitted before driving into multi-storey car parks, garages, underground garages and tunnels.
- ▷ Do not exceed the maximum roof load, maximum vehicle weight and maximum axle loads.

For information on maximum permitted loads and weights:

- ▷ Please see the chapter “WEIGHTS” on page 328.
- ▷ Do not exceed the maximum permitted roof transport system load of 70 kg.
- ▷ If you are not using the roof transport system, remove it completely from the vehicle in order to save fuel and reduce noise.

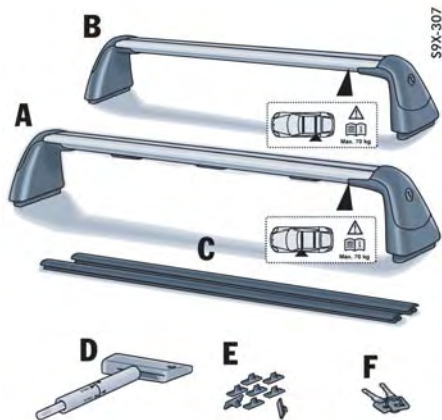

- A - Front carrier, long
- B - Rear carrier, short
- C - Cover trims
- D - Torque wrench
- E - Roof channel protectors
- F - Key

Fitting the roof transport system

When fitting the roof transport system for the first time, the front and rear carrier must be adjusted according to the width of the vehicle.

Roof channel protectors can also be secured to the vehicle when fitting the roof transport system for the first time. These protectors make it easier to fit the roof transport system and protect the fastening recesses in the roof rails from damage.



1. Open the cover flap on the roof rails.
 2. Unscrew plastic screws from the retaining threads.
- ▷ Make sure not to lose the plastic screws.

Note

When you have removed the roof transport system, the plastic screws can be screwed back into the retaining threads to prevent dirt from getting into the threads.

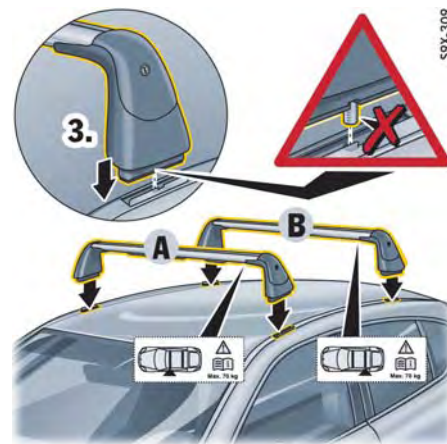

3. Position the long carrier **A** at the front and the short carrier **B** at the rear loosely on the fastening recesses.
- ▷ Fastening screws on the carriers must not protrude underneath as this would damage the vehicle.
 - ▷ Make sure that the carriers are aligned in accordance with the specifications on the stickers on the underside of the carriers.

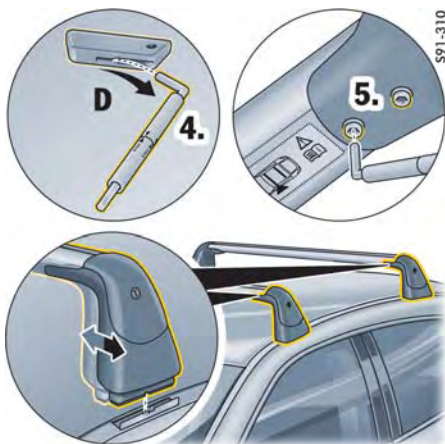

4. Remove the handle of the torque wrench **D**.
 5. Loosen screws on the underside of the carriers using the short side of the torque wrench.
The carriers can be adjusted to fit the width of the vehicle.
- ▷ Once you have adjusted the width of the carriers, tighten the screws again using the short side of the torque wrench.

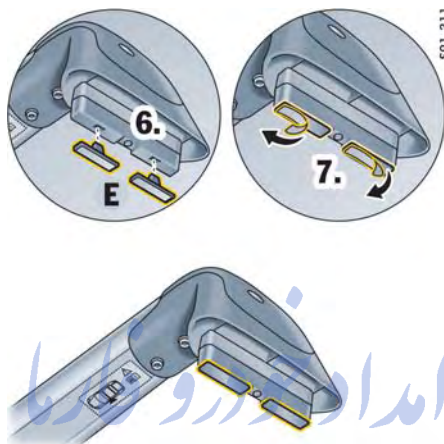

6. Lift up the carriers slightly and fit roof channel protectors **E** into the mounts on the underside of the carriers.
 7. Remove protective film from the bonding areas of the roof channel protectors.
- ▷ Check that the fastening recesses on the roof rails are perfectly clean and free of dust and grease.

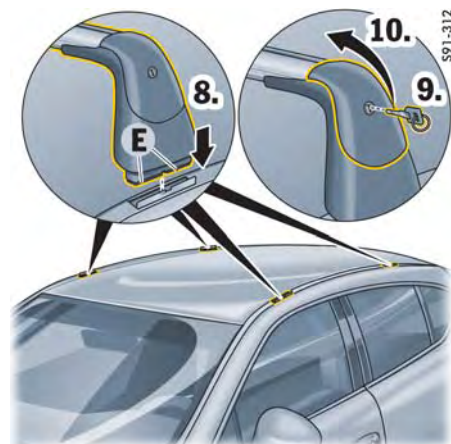

8. Carefully fit the carriers into the fastening recesses.
The roof channel protectors **E** are bonded permanently into the fastening recesses. These protect the paintwork in the fastening recesses during repeated fitting of the roof transport system and make fitting easier.
9. Unlock the cover flaps with the key.
10. Fold the cover flaps up fully.



11. Tighten the fastening screws on the carriers using the torque wrench **F** until the arrow markings on the torque wrench are perfectly aligned.

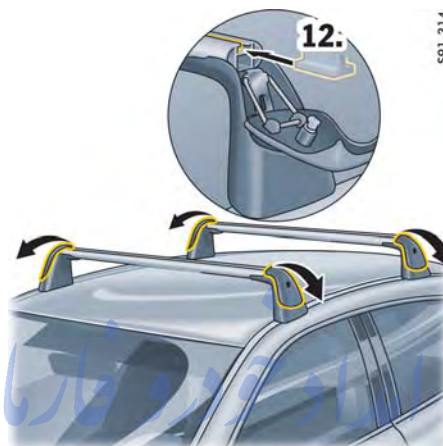

12. Fold the cover flaps on the carriers down fully and slide the desired attachment into the carriers.



13. Cut the cover trims **C** to size and slide them sideways into the carriers or press them into the carriers from above to protect from moisture and dirt.

14. Lock the cover flaps.

Repeated fitting of the roof transport system

Steps **5** to **7** can be omitted when the roof transport system is fitted on the same vehicle again.

FarmaSOS.com

Loading Information

Definitions

The rear-axle load is the vehicle weight on the rear axle plus the weight of the transported load.

The Curb weight - actual weight of your vehicle - vehicle weight including standard and optional equipment, fluids, and emergency tools. This weight does not include passengers and cargo.

The Gross Vehicle Weight is the sum of the curb weight and the weight of passengers and cargo combined.

The Gross Vehicle Weight Rating is the maximum total weight of vehicle, passengers, luggage, hitch, trailer tongue load and optional equipment.

The Gross Axle Weight Rating is the maximum load limit for the front or the rear axle. This information is located on the safety compliance sticker located in the driver's side door jamb.

For determining the compatibility of the tire and vehicle load capabilities:

- ▷ Please see the chapter "TIRES AND WHEELS" on page 280.

The load capacity coefficient (e.g. "106") is a minimum requirement. For more information:

- ▷ Please see the chapter "INSCRIPTION ON RADIAL TIRE" on page 288.

The Gross Combined Weight Rating is the maximum total weight rating of vehicle, passengers and cargo.

The Vehicle Capacity Weight - Load Limit - is the maximum total weight limit specified of the load (passengers and cargo) for the vehicle. This is the maximum weight of passengers and cargo that can be loaded into the vehicle. This information can be found on the tire pressure plate.

The maximum loaded vehicle weight is the sum of curb weight, accessory weight, vehicle capacity weight and production options weight.

The load rating is the maximum load that a tire is rated to carry for a given inflation pressure.

The maximum load rating is the load rating for a tire at the maximum permissible inflation pressure.

The cargo capacity is the permissible weight of cargo, the subtracted weight of passengers from the load limit.

- ▷ Never exceed the permissible limits.

Danger!

Risk of personal injury or death. Injuries are much more likely in an accident if persons ride in the cargo area.

- ▷ Persons must ride only on the seats provided for this purpose.
- ▷ Make sure that everybody fastens their safety belts.

Risk of loss of control, damage to the vehicle and serious personal injury or death.

- ▷ Never exceed the specified axle loads. Overloading can shorten the service life of the tires and car, as well as lead to dangerous vehicle reactions and long braking distances. Damage due to overloading is not covered by the vehicle warranty.
-

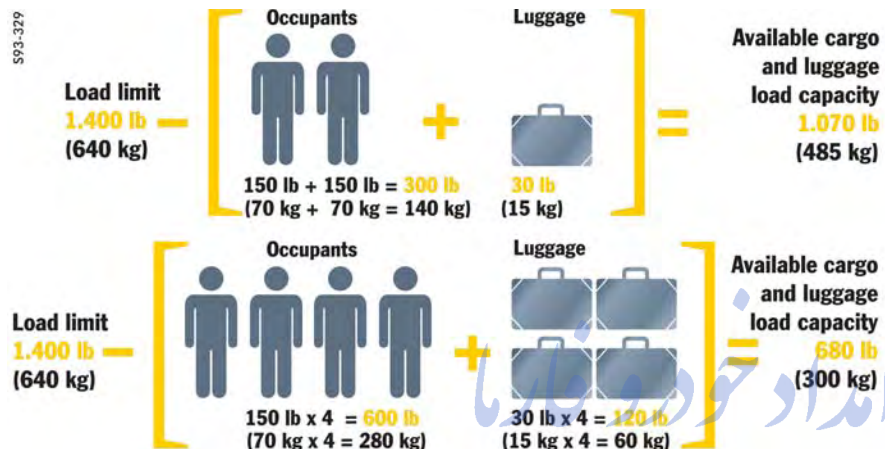

Example for determining the combined weight of occupants and cargo

Vehicle Load Capacity

- ▷ The combined weight of occupants and cargo should never exceed the weight shown on the tire plate in the vehicle. Please see the chapter “TIRE PRESSURE PLATE” on page 323.
- ▷ Never exceed the number of passengers shown on the tire pressure plate in the vehicle.

Determining the combined weight of occupants and cargo:

- ▷ Add the weight of all occupants and then add the total luggage weight (figure).

Steps for determining correct load limit

1. Locate the statement “The combined weight of occupants and cargo should never exceed XXX pounds” on your vehicle’s placard (depending on the date of manufacture).
2. Determine the combined weight of the driver and passengers that will be riding in your vehicle.

3. Subtract the combined weight of the driver and passengers from XXX kilograms or XXX pounds.
4. The resulting figure equals the available amount of cargo and luggage load capacity. For example, if the “XXX” amount equals 1400 lbs. and there will be five - 150 lb passengers in your vehicle, the amount of available cargo and luggage load capacity is 650 lbs. [1400 - 750 (5 x 150) = 650 lbs.].
5. Determine the combined weight of luggage and cargo being loaded on the vehicle. That weight may not safely exceed the available cargo and luggage load capacity calculated in Step 4.

Parking

ParkAssist.....	239
Rearview Camera.....	241
Swivelling Down Mirror Glass as Parking Aid.....	242
Garage Door Opener.....	243

امداد خودرو فارما

تلفن شبانه روزی: ۰۲۱-۸۸۸۶۲۰۸۵

FarmaSOS.com

ParkAssist

When the driver is parking and maneuvering the vehicle, ParkAssist indicates the distance between the vehicle and an obstacle by means of signal tones.

- ▷ For information on the ParkAssist visual display and the rearview camera, please refer also to the section “ParkAssist” in the operating instructions for the Porsche communication Management (PCM).

ParkAssist is activated automatically when reverse gear is selected and the ignition is on. If the vehicle has front ParkAssist, this automatically provides a warning if

- the distance between the vehicle and an obstacle in front is less than approx. 49 in. (100 cm).

A warning signal sounds.

- the distance between the vehicle and an obstacle in front is less than approx. 32 in. (80 cm).

The ParkAssist visual display appears on the central screen of the Porsche communication system.

Front and rear ParkAssist is **not** activated in the following situations:

- At a speed of more than approx. 9 mph (15 km/h) or
- when the electric parking brake is activated or
- when the PDK selector lever is at position **P**.

S91-144

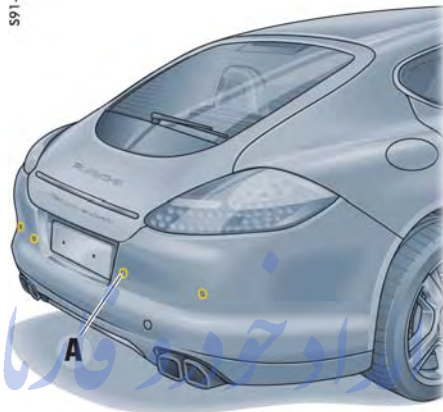

Warning!

Injury hazard. Even with ParkAssist, responsibility for parking and for assessing obstacles lies with the driver. A continuous tone sounds when there is a risk of collision.

- ▷ Make sure that no persons, animals or obstacles are within the maneuvering area.
- ▷ If the continuous tone sounds, do not move the vehicle any close to the obstacle.

S91-203



Sensors

Four ultrasound sensors **A** in the rear bumper and six sensors **B** in the front bumper (depending on vehicle equipment) measure the distance to the closest obstacle:

- Range behind the vehicle: approx. 71 in. (180 cm)
- Range at the side of the vehicle: approx. 31 in. (80 cm)
- Range in front of the vehicle: approx. 47 in. (120 cm)

Obstacles cannot be detected in the “blind” sensor area (above and below the sensors, e.g. objects hanging down or close to the ground).

Maintenance notes

- ▷ The sensors must always be kept free of dust, ice and snow in order to ensure that they are fully functional.
- ▷ Do not damage sensors by abrasion or scratching.
- ▷ Maintain sufficient distance when cleaning with high-pressure cleaning equipment. The sensors will be damaged if the pressure is too high.

Signal tones/function

When reverse gear is selected, ParkAssist confirms that it is switched on by issuing a **short signal tone**.

If the vehicle has front ParkAssist, **no** signal tone will be issued when reverse gear is selected. Instead, the ParkAssist visual display will appear on the central screen of the Porsche communication system.

A detected obstacle is signalled by an **intermittent tone**. The intervals decrease as the obstacle is approached.

If the distance drops to less than approx. 14 in. (35 cm), a **continuous tone** sounds.

- ▷ Set the radio volume so that the signal tones are not drowned out.

The volume of the signal tones can be changed individually.

For information on changing the signal tone volume:

- ▷ Please see the chapter "ADJUSTING PARKASSIST VOLUME" on page 150.

Warning!

Risk of accidents. Even when using ParkAssist, the driver is still responsible for taking due care when parking and when assessing obstacles.

- ▷ Do not reverse any further once a continuous tone sounds. **Risk of collision!**

Limits of ultrasonic measurement

- ParkAssist cannot detect sound-absorbing obstacles (e.g. winter driving, powder snow),
- sound-reflecting obstacles (such as glass surfaces and flat painted surfaces),
- and very thin obstacles (e.g. thin posts).

Other ultrasound sources (such as the pneumatic brakes of other vehicles and jack hammers) can interfere with the detection of obstacles.

تلفن شبانه روزی: ۰۲۱-۸۸۸۶۲۰۸۵

FarmaSOS.com



S91-026

ParkAssist is ready for operation again when the interference has been eliminated.

In the event of a **permanent fault** in ParkAssist, a continuous tone sounds for three seconds after reverse gear has been selected.

Possible causes:

- Dirt, ice or snow on the sensors.
- ▷ Clean the sensors carefully.
- Defect or system fault.
- ▷ Have the fault corrected. Please contact a qualified specialist workshop. We recommend that you have an authorized Porsche dealer to do this work as they have trained workshop personnel and the necessary parts and tools.



S91-166

Deactivating ParkAssist

On vehicles with front and rear ParkAssist, the ParkAssist can be manually deactivated.

- ▷ Press button **A** on the overhead operating console.
The indicator light on the button lights up.
ParkAssist is switched off.

Fault indication

Note

Correct operation is no longer guaranteed if there is a temporary fault (e.g. caused by ice formation or heavy soiling on the sensors).

Rearview Camera

The rearview camera is located on the underside of the tailgate.

- ▷ Please refer to the chapter "REARVIEW CAMERA" in the separate PCM operating instructions.
- ▷ Always keep the rearview camera clean and free of ice and snow so that vision is not impaired.

For car care instructions:

- ▷ Please see the chapter "CAR CARE INSTRUCTIONS" on page 269.

تلفن شبانه روزی: ۰۲۱-۸۸۸۶۲۰۸۵

FarmaSOS.com



Swivelling Down Mirror Glass as Parking Aid

When reverse gear is engaged, the mirror on the **passenger's side** swivels down slightly to show the curb area.

Preconditions

- The ignition must be switched on.
- The function must be activated on the multi-function display.

For further information on setting the parking aid:

- ▷ Please see the chapter "ADJUSTING REVERSING OPTIONS" on page 144.

Swivelling down mirror glass manually

If the function was deactivated on the multi-function display, the exterior mirror on the passenger's side can also be swivelled down manually.

1. Engage reverse gear.
The indicator light on the selection button **A** for adjusting the exterior mirror on the driver's side lights up.
2. Press the selection button **B** for adjusting the exterior mirror on the passenger's side. The mirror on the passenger's side swivels down.

Note on operation

The position of the automatically lowered mirror glass can be changed as required using the adjustment button **C**. This setting is stored on the car key on vehicles with driver memory or comfort memory.

Moving mirror to its initial position

The mirror swivels back to its initial position:

- after a certain time delay, if the vehicle is shifted out of reverse gear, or
- immediately, if the vehicle reaches a speed of more than 9 mph (15 km/h).



The exterior mirror on the passenger's side can also be moved to its initial position manually.

- ▷ Press the selection button **A** for the exterior mirror on the driver's side.



Garage Door Opener

The garage door opener of your Porsche replaces up to three original remote controls used to operate various devices (e.g. garage door, gate to your property, alarm system).

You have the option of assigning up to 3 different signals to the buttons ,  and  on the overhead operating console keypad, provided the original remote control is compatible with the HomeLink® system.

Note

- ▷ Please read the instructions for the original remote control.

Warning!

Risk of accidents when using the garage door opener if persons, animals or objects are within the range of movement of the equipment that is being operated.

- ▷ When using the garage door opener, ensure that no persons, animals or objects are within the range of movement of the equipment that is being operated.
- ▷ Observe the safety notes for the original remote control.

Notes on operation

- ▷ When the button is pressed, the transmitter unit sends the signal forward in direction of travel. Always align the vehicle with the receiver. Otherwise, range restrictions cannot be ruled out.
- ▷ Before selling the vehicle, delete the programmed signals for the garage door opener on the keypad.
- ▷ Please read the instructions for the original remote control to find out whether the original remote control has fixed or changeable code.

Preconditions

In order to delete programmed signals and store garage door opener signals,



- the ignition must be switched on **and**
- the turn signals must be off.

When using the garage door opener, the vehicle must be within the range of the receiver.



Deleting programmed signals from the keys

This process deletes the standard factory-set codes. Do not repeat this process if you want to assign additional signals to the buttons.

- ▷ Keep the two outer buttons  and  on the overhead operating console keypad pressed for approx. 20 seconds until the indicator light **A** on the button  starts to flash quickly.

Assigning garage door opener signal to key with fixed code system

1. The standard factory-set codes must be deleted before programming for the **first** time.
2. Press and hold the desired button on the overhead operating console keypad until the indicator light **A** on the button  starts to flash slowly. You now have 5 minutes to teach the button.
3. Hold the original remote control approx. 12 in. (30 cm) away from the marked position (**figure**) and press and hold the transmit button until the vehicle's turn signal lights flash on and off three times and/or the indicator light **A** starts flashing quickly.

The turn signal lights flash three times and the indicator light **A** flashes quickly to confirm that the new signal has been programmed successfully.

Several attempts with different distances between the vehicle and the original remote control may be necessary.

4. The turn signal lights will flash once when the 5 minutes teaching time are up. Repeat steps 2 to 3.
5. Repeat steps 2 to 4 to assign signals to the other buttons.

Assigning garage door opener signal to button with changeable code system

1. The standard factory-set codes must be deleted before programming for the **first** time.
2. Press and hold the desired button on the overhead operating console keypad until the indicator light **A** on the button  starts to flash slowly. You now have 5 minutes to teach the button.
3. Hold the original remote control approx. 12 in. (30 cm) away from the marked position (**figure**) and press and hold the transmit button until the vehicle's turn signal lights flash on and off three times and/or the indicator light **A** starts flashing quickly.

The turn signal lights flash three times and the indicator light **A** flashes quickly to confirm that the new signal has been programmed successfully.

Several attempts with different distances between the vehicle and the original remote control may be necessary.

4. To synchronize the system:

Press the programming button on the receiver of the garage door opener. Afterwards, you usually have approx. 30 seconds to initiate step 5.

5. Press the button you selected in step 2 on the overhead operating console keypad. (You must press the button on the keypad several times to complete the setting process for some devices.)

6. Repeat steps 2 to 5 to assign signals to the other buttons.

Notes

- ▷ Please consult an authorized Porsche dealer if you have not been able to successfully assign signals to the buttons even though you have carefully followed the instructions in this section and the operating instructions for the original remote control. Your authorized Porsche dealer has a list of all garage door opener signals that can be adapted.
- ▷ Make sure that the battery in the remote control for the garage door opener is new. If the battery voltage is inadequate, faults may

occur in signal transmission. The system in the vehicle then learns the wrong code, which will not be recognized reliably by the garage door opening mechanism.

Reprogramming an individual button on the keypad

1. Press and hold the button you want to program on the overhead operating console keypad (approx. 20 seconds) until the indicator light **A** on the button  starts to flash slowly. You now have 5 minutes to teach the button.
2. Hold the original remote control approx. 12 in. (30 cm) away from the marked position (**figure**) and press and hold the transmit button until the vehicle's turn signal lights flash on and off three times and/or the indicator light **A** starts flashing quickly.
 - The turn signal lights flash three times and the indicator light **A** flashes quickly to confirm that the new signal has been programmed successfully.Several attempts with different distances between the vehicle and the original remote control may be necessary.
3. The turn signal lights will flash once when the 5 minutes teaching time are up. Repeat steps 1 to 2.
4. Repeat steps 1 to 3 to assign signals to the other buttons.

Operating the garage door opener

- ▷ Press the corresponding button on the overhead operating console keypad. The indicator light **A** lights up during signal transmission.

Alarm System and Theft Protection

Alarm System and Passenger	
Compartment Monitoring	247
Immobilizer	250
Locking the Steering Column	250
Theft Protection	250

امداد خودرو فارما

تلفن شبانه روزی: ۰۲۱-۸۸۸۶۲۰۸۵

FarmaSOS.com

Alarm System and Passenger Compartment Monitoring

USA: KR55WK50138

Canada: 7812D-5WK50138

This device complies with:
Part 15 of the FCC Rules
RSS-210 of Industry Canada.

Operation of this device is subject to the following two conditions:

- It may not cause harmful interference, and
- it must accept any interference received including interference that may cause undesired operation.

Note

The manufacturer is not responsible for any radio or TV interference caused by unauthorized modifications to this equipment. Such modification could void the user's authority to operate the equipment.

Warning!

Any changes or modifications not expressly approved by Porsche could void the user's authority to operate this equipment.

The alarm system monitors the following alarm contacts:

- Alarm contacts in doors, tailgate, engine compartment lid and headlights
- Interior surveillance: Movement in the interior when the vehicle is locked, e.g. attempted theft after breaking a window.
- Inclination sensor: Tilting of the vehicle (e.g. attempt to tow away the vehicle).

If one of these alarm contacts is interrupted, the alarm horn sounds for approx. 30 seconds and the emergency flasher flashes on and off. After 5 seconds of interruption, the alarm is triggered again. This cycle is repeated ten times.

Switching on

- ▷ The alarm system is activated when the vehicle is locked.

Switching off

- ▷ The alarm system is deactivated when the vehicle is unlocked.

Note on operation

- ▷ If you unlock the vehicle with the emergency key in the door lock, you must switch the ignition on (ignition lock position **1**) within 10 seconds of opening the door in order to prevent the alarm system from being triggered.

The vehicle is locked again automatically after 20 seconds if no doors are opened.

Switching off the alarm system if it is triggered

- ▷ Unlock vehicle doors with the remote control **or** Switch on ignition.

Switching off interior surveillance and inclination sensor

If people or animals are remaining in the locked vehicle or the vehicle is being transported on a train or ship, for example, the interior surveillance system and inclination sensor must be switched off temporarily.

- ▷ Inform any persons remaining in the vehicle that the alarm system will be triggered if the door is opened.

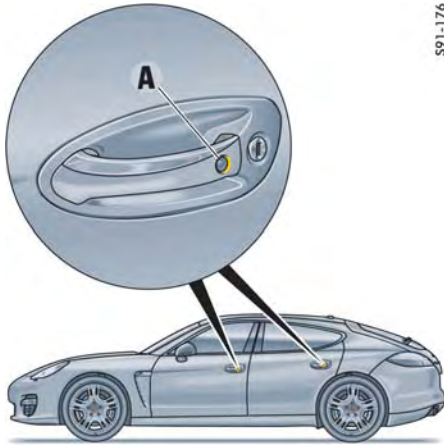

S91-176

On vehicles with Porsche Entry & Drive

- ▷ Quickly press button **A** in the door handle **twice**.
The emergency flasher flashes slowly once. The doors are locked but can be opened from the inside by pulling once on the front door opener or by pulling twice on the rear door opener.

Note on operation

The interior surveillance system and inclination sensor remain switched off if:

- The interior surveillance system and inclination sensor were switched off when you last locked the vehicle **and** the vehicle was locked automatically 30 seconds after unlocking because no door was opened.

Using the car key

- ▷ Quickly press button  on the remote control **twice**.
The emergency flasher flashes slowly once. The doors are locked but can be opened from the inside by pulling once on the front door opener or by pulling twice on the rear door opener.



S91-172

Using the rocker switch

The rocker switch to switch off the passenger compartment monitoring system is located next to the driver's seat.

1. Apply the electric parking brake.
2. Remove ignition key.
On vehicles **with** Porsche Entry & Drive:
Switch off the ignition.
3. Open the driver's door.
4. Press the rocker switch.
The rocker switch symbol lights permanently.
5. Lock the vehicle.

Alarm system is activated

- The indicator lights flash quickly while you are locking the vehicle, then flash normally.

Alarm system is activated, interior surveillance and inclination sensor are switched off

- The indicator lights flash quickly while you are locking the vehicle, go out for 10 seconds and then flash normally.

Faults in the central locking system and alarm system

The indicator lights come on for 10 seconds, flash at double speed for 20 seconds and then flash normally.

Avoiding false alarms

- ▷ If people or animals are remaining in the locked vehicle or the vehicle is being transported on a train or ship, for example, the interior surveillance system and inclination sensor must be switched off temporarily.
- ▷ Always close the slide/tilt roof and all door windows.

Emergency flasher flashes **twice and an acoustic signal will sound twice.**

The vehicle doors, the rear lid and the rear window are locked but the doors can be opened from the inside by pulling once on the front door opener or by pulling twice on the rear door opener.

- ▷ Inform any persons remaining in the vehicle that the alarm system will be triggered if the door is opened.

Note on operation

If the ignition is switched on after pressing the rocker switch, the passenger compartment monitoring system is activated again. The symbol on the rocker switch will flash.

Activating the alarm system and the passenger compartment monitoring system

- ▷ Unlock the vehicle and lock it again.

Fault indication

If the monitoring system could not be deactivated the symbol on the rocker switch will flash (e.g. the rocker switch is pressed with the ignition on).

For deactivating the passenger compartment monitoring:

- ▷ Switch off ignition.
- ▷ Press the rocker switch.
- ▷ Lock the vehicle.



B - Indicator light for alarm system – example: driver's door

Function indication

The locking condition of the vehicle is indicated by the indicator lights **B** in the front doors flashing at different frequencies.

The indicator lights go out when the vehicle is unlocked.

Immobilizer

There is a transponder (an electronic component), containing a stored code, in each key. Before the ignition is switched on, the ignition lock checks the code.

The immobiliser can be deactivated and the engine started only using an authorised ignition key.

Locking the Steering Column

Vehicles without Porsche Entry & Drive

Unlocking the steering column automatically

- ▷ Insert the ignition key into the ignition lock.

Locking the steering column automatically

- ▷ Remove the ignition key.

Vehicles with Porsche Entry & Drive

Unlocking the steering column automatically

- ▷ Turn the control unit out of ignition lock position **0**.

Locking the steering column automatically

- ▷ Open the driver's door (with the ignition switched off).

Locking the steering column manually

- ▷ Once the ignition is switched off, turn the control unit to ignition lock position **3** again and hold it there for **2 seconds**. The steering column locks with an audible click.

Theft Protection

When leaving the vehicle, always:

- ▷ Close all door windows.
- ▷ Close the slide/tilt roof.
- ▷ Remove the ignition key (or switch ignition off on vehicles with Porsche Entry & Drive).
- ▷ Lock the glove box.
- ▷ Close all storage compartments.
- ▷ Remove valuables, vehicle registration documents, telephone and house keys from the vehicle.
- ▷ Cover the luggage compartment with the retractable luggage compartment cover.
- ▷ Close the tailgate.
- ▷ Lock all doors.

امداد خودرو فارما

تلفن شبانه روزی: ۰۲۱-۸۸۸۶۲۰۸۵

FarmaSOS.com

Maintenance and Car Care

Exercise Extreme Caution when Working on your vehicle.....	252
Engine Oil	254
Checking Engine-Oil Level	254
Topping Up Engine Oil	255
Checking Coolant Level and Adding Coolant	257
Brake Fluid	258
Washer Fluid	259
Power Steering	260
Changing Air Cleaner	261
Changing Particle Filter.....	261
Wiper Blades	261
Emission Control System	262
How Emission Control Works	263
Fuel Economy	264
Operating Your Porsche in other Countries... ..	264
Fuel.....	265
Fuel Can.....	267
Fuel Recommendations.....	268
Fuel Evaporation Control	269
Car Care Instructions.....	269

Exercise Extreme Caution when Working on your vehicle



Ignoring the following instructions may cause serious personal injury or death.

- ▷ The engine compartment of any motor vehicle is a potentially hazardous area. If you are not fully familiar with proper repair procedures, do not attempt the adjustments described on the following pages.
- ▷ Only work on your vehicle outdoors or in a well ventilated area.
- ▷ Ensure that there are no open flames in the area of your vehicle at any time when fuel fumes might be present. Be especially cautious of devices such as hot water heaters which ignite a flame intermittently.
- ▷ Before working on any part in the engine compartment, turn the engine off and let it cool down sufficiently. Hot engine compartment components can burn skin on contact.
- ▷ Be alert and cautious around the engine at all times while it is running. If you have to work on the engine while it is running, always put the parking brake on **and** put the PDK selector lever in position **P or N**.
- ▷ In particular, be very careful to ensure that items of clothing (ties, shirt, sleeves etc.), jewelry, long hair, hand or fingers cannot get

caught in the fan, belts or other moving parts. The radiator and radiator fans are in the front of the car.

The fans can start or continue running as a function of temperature, even with the engine switched off.

Carry out work in these areas only with the engine off and exercise extreme caution.

- ▷ Your Porsche is equipped with an electronic ignition system. When the ignition is on, high voltage is present in all wires connected with the ignition system; therefore, exercise extreme caution when working on any part of the engine while the ignition is on or the engine is running.
- ▷ Always support your car with safety stands if it is necessary to work under the car. The jack supplied with the car is not adequate for this purpose. Switch off level control of air suspension and height adjustment. Please see the chapter "RAISING THE VEHICLE WITH A LIFTING PLATFORM, TROLLEY JACK OR STANDARD JACK" on page 290.
- ▷ When working under the car without safety stands but with the wheels on the ground, make sure the car is on level ground, the wheels are blocked, and that the engine cannot be started. Withdraw ignition keys (switch ignition off in vehicles that have Porsche Entry & Drive).

- ▷ Do not smoke or allow an open flame around the battery or fuel. Keep a fire extinguisher close at hand.
- ▷ Incomplete or improper servicing may cause problems in the operation of the car. If in doubt about any servicing, have it done by your authorized Porsche dealer. Improper maintenance during the warranty period may affect your Porsche warranty coverage.
- ▷ Supplies of fluids, e.g. engine oil, washer fluid, brake fluid or coolant, are hazardous to your health. Keep these fluids out of children's reach and dispose of them in accordance with the appropriate regulations.
- ▷ Some countries require additional tools and special spare parts to be carried in your vehicle. Please make enquiries before driving abroad.

Technical Modifications

- ▶ Modifications may be carried out on your vehicle only if approved by Porsche. This ensures that your Porsche will remain reliable and safe to drive, and that it will not be damaged as a result of the modifications. Your authorized Porsche dealer will be pleased to advise you.

Safety notes!

- ▶ Only use genuine Porsche spare parts for your vehicle or spare parts of similar quality which have been manufactured according to the specifications and production requirements of Porsche. These parts are available from your authorized Porsche dealer or a qualified specialist workshop. Safety-related accessories should only be used if they are from the Porsche Tequipment range or are tested and approved by Porsche. Your authorized Porsche dealer will be pleased to advise you and answer any questions you may have. However, the use of other parts or accessories may adversely affect the safety of your vehicle, and Porsche can take no responsibility for any loss or damage caused by their use. Even if the supplier of other accessories or parts is a recognized supplier, the safety of your vehicle may still be affected if such items are installed. Due to the large variety of products offered in

the accessory market, it is not possible for Porsche to inspect and approve every one.

- ▶ In addition, please note that the use of replacement parts that are not genuine Porsche parts or approved parts, or the use of accessories not approved by Porsche may also detrimentally affect your vehicle warranty.
- ▶ Check your vehicle regularly for signs of damage. Damaged or missing aerodynamic components, such as spoilers or underbody panels, impair vehicle handling and must therefore be replaced immediately.

Radiator fan

For information on radiator fans:

- ▶ Please see the chapter “RADIATOR FANS” on page 258.

Warning!

Danger of injury. After the ignition is switched off, the engine compartment and coolant temperatures are monitored for approx. 30 minutes. During this period, and depending on temperature, the radiator fan may continue to run or start to run.

- ▶ Carry out work in these areas only with the engine off and exercise extreme caution.

Measurements on test stands

Performance test

Performance tests on roller-type test stands are not approved by Porsche.

Brake tests

Brake tests must be performed only on roller-type test stands.

The following limit values must not be exceeded on roller-type test stands:

- Test speed 4.7 mph (7.5 km/h)
- Test duration 20 seconds

Testing the electric parking brake

Electric parking brake tests on the brake test stand must only be performed with the ignition switched on and with the manual gearshift lever in neutral or the Porsche Doppelkupplung selector lever in position **N**.

The vehicle switches automatically to brake test stand mode, in which the electric parking brake can be tested.

The message “Electric parking brake in service mode” appears on the multi-function display in the instrument panel.

Balancing wheels on the vehicle

During finish balancing of the wheels, the entire vehicle must be lifted and the wheels must be free to turn.

Engine Oil

It is important to perform oil changes regularly in accordance with the intervals specified in your **Maintenance Schedule**.

Engine oil consumption

It is normal for your engine to consume oil. The rate of oil consumption depends on the quality and viscosity of oil, the speed at which the engine is operated, the climate, road conditions as well as the amount of dilution and oxidation of the lubricant.

If the vehicle is used for repeated short trips, and consumes a normal amount of oil, the engine oil measurement may not show any drop in the oil level at all, even after 600 miles (1000 km) or more. This is because the oil is gradually becoming diluted with fuel or moisture, making it appear that the oil level has not changed.

The diluting ingredients evaporate out when the vehicle is driven at high speeds, as on an expressway, making it then appear that oil is excessively consumed after driving at high speeds.

If the conditions you drive your vehicle in are dusty, humid, or hot, the frequency of the oil change intervals should be greater.

If the vehicle is driven at a high rate of speed, climatic conditions are warm, and the load is high, the oil should be checked more frequently, as driving conditions will determine the rate of oil consumption.

- The engine in your vehicle depends on oil to lubricate and cool all of its moving parts. Therefore, the engine oil should be checked regularly and kept at the required level.
- Make it a habit to have the engine oil level checked with every refueling.
- The oil pressure warning light is not an oil level indicator. The oil pressure warning light indicates serious engine damage may be occurring when lit, if engine rpm is above idle speed.

تلفن شبانه روزی: ۰۲۱-۸۸۶۲۰۸۵

FarmaSOS.com

Checking Engine-Oil Level

- ▷ Check the oil level on the multi-function display at regular intervals before refuelling.
- ▷ Please see the chapter “OIL LEVEL DISPLAY AND MEASUREMENT OF THE ENGINE OIL LEVEL” on page 121.

Warning!

Engine oil is hazardous to your health and may be fatal if swallowed.

- ▷ Keep engine oil out of children's reach.

Used engine oil contains chemicals that have caused cancer in laboratory animals.

- ▷ Always protect your skin by washing thoroughly with soap and water.

Top-up quantity

The difference between the minimum and maximum marks on the segment display is approx. 1.06 US quarts (1 liter). One segment of the display corresponds to a top-up quantity of approx. 0.26 US quarts (0.25 liters).

- ▷ Never add more engine oil than required to reach the maximum mark.



Oil-level warning

If the oil level is too low, this is indicated by the oil-warning light on the multi-function display.

- ▷ Correct the oil level as soon as possible.
- ▷ Please see the chapter “OVERVIEW OF WARNING MESSAGES” on page 152.

Note on operation

If the engine compartment lid is opened and no oil is added, the warning message appears again after at least 6 miles (10 km).



Warning!

Risk of injury. The radiator fans can start running when a certain temperature is reached, even with the engine switched off.

Risk of burns from hot parts in the engine compartment.

- ▷ Exercise extreme caution when working in the engine compartment.

Topping Up Engine Oil

Porsche recommends **Mobil** .

Complies with approval ¹⁾	Viscosity class ²⁾
Porsche A40	SAE 0W - 40 ³⁾ SAE 5W - 40 ⁴⁾ SAE 5W - 50 ⁴⁾

¹⁾ Generally, you can find details on the manufacturer approvals on the oil containers or as a notice displayed by the retailer.

The current approval status is also available from your authorized Porsche dealer.

²⁾ SAE viscosity class - Example: SAE 0W - 40
Specification 0W = Viscosity specification for low temperatures (winter).
Specification 40 = Viscosity specification for high temperatures.

³⁾ For all temperature ranges.

⁴⁾ For the temperature range over -13 °F (-25 °C).

Always observe the following points:

- Use engine oils approved by Porsche only.
This is a precondition for optimum and problem-free driving.
- Regular oil changes are part of servicing.
It is important that the service intervals, particularly the oil change intervals, are observed in accordance with the specifications in the “Maintenance” booklet.

- Oils approved by Porsche can be mixed with each other.
- Porsche engines are designed so that no oil additives may be used.
- A label is located in the engine compartment, which provides you with information on suitable oil for your engine.

Your authorized Porsche dealer will be pleased to advise you.



Caution!

Fire hazard if engine oil comes into contact with hot engine parts.

Risk of damage if engine oil comes into contact with the drive belt.

- ▷ Exercise extreme caution when topping up engine oil.
- ▷ Top up engine oil only with the engine stopped and ignition switched off.
- ▷ Please see the chapter “EXERCISE EXTREME CAUTION WHEN WORKING ON YOUR VEHICLE” on page 252.



1. Unscrew cap on oil filler opening.
2. Top up engine oil according to the display on the multi-function display.
One segment of the display corresponds to a top-up quantity of approx. 0.26 US quarts (0.25 liters).
3. Carefully close cap of the oil filler opening.

After opening the hood, the oil level can only be measured after driving for at least 6 miles (10 km).

Oil change

The engine oil has to be changed regularly at the intervals listed in your **Maintenance Schedule**.

▷ Please see the chapter "FILLING CAPACITIES" on page 329.

We recommend that you have the engine oil changed at your Porsche dealer, who has the required oils and the necessary filling equipment.

If you suspect an oil leak in the engine have your dealer check it out immediately.

All current engine oils are compatible with each other, i.e. when making an oil change it is not necessary to flush the engine if you wish to use a different brand or grade of oil. Since, however, each brand of oil has a special composition, you should, if possible, use the same oil brand if it becomes necessary to top up between oil changes.

Porsche engines have long intervals between oil changes. You can make best use of these long oil change intervals by using multigrade oils since these are largely independent of seasonal fluctuations in temperature.

If your vehicle is used frequently in stop-and-go traffic in cold weather, the engine will not always be properly warmed up.

Condensation from products of combustion may accumulate in the oil. In this case, it is advisable to change the oil more frequently so that your engine once again has 100% efficient engine oil.

Engine oil performance class

Engine oil is not only a lubricant, but also serves to keep the engine clean, to neutralize the contaminants which penetrates into the engine through combustion and to protect the engine against corrosion.

To perform these functions, the oil is provided with additives which have been specially developed for these functions.

The efficiency of an oil is expressed, for example, by the API, ILSAC or ACEA classifications.

Viscosity

Like all liquids, engine oil is viscous when cold, and thin-bodied when warm. The viscosity of an oil is expressed by its SAE class. For cold viscosity (measured at temperatures below 32 °F/0 °C) the SAE class is given as a number and the letter "W" (as in winter), for hot viscosity (measured at 212 °F/100 °C) the SAE class is given only as a number.

The viscosity of an oil is, therefore, always the same if it has the same number of an SAE class.

Oils with two viscosities are called multigrade oils; oils with only one viscosity are termed single-grade oils.

Single-grade oils can not be used in your engine.

The viscosity of the engine oil for your Porsche has to be chosen according to the ambient temperature given in the engine oil recommendation table.

Checking Coolant Level and Adding Coolant

The coolant provides year-round protection from corrosion and freezing down to $-31\text{ }^{\circ}\text{F}$ ($-35\text{ }^{\circ}\text{C}$) ($-40\text{ }^{\circ}\text{F}$ ($-40\text{ }^{\circ}\text{C}$) in Nordic countries).

Observe the following points:

- ▷ Use only antifreeze authorised by Porsche.
- ▷ Check the coolant level regularly.

Coolant level

When the **engine is cold** and the vehicle is level, the red display must be under the arrow between the minus and plus markings.

- ▷ Add coolant if necessary.

The maximum fill level is reached when the red display is under the plus marking.

- ▷ Please see the chapter "OVERVIEW OF WARNING MESSAGES" on page 152.
- ▷ Please see the chapter "EXERCISE EXTREME CAUTION WHEN WORKING ON YOUR VEHICLE" on page 252.



Checking when engine is cold

1. Open cap on the reservoir carefully and allow any overpressure to escape. Then unscrew cap completely.
2. Read off the engine coolant level.
3. Top up with coolant if necessary. Do not top up over the plus marking. Only add a mixture of antifreeze and water in equal parts.
Antifreeze in coolant:
50 % provides antifreeze protection down to $-31\text{ }^{\circ}\text{F}$ ($-35\text{ }^{\circ}\text{C}$).
4. Screw the cap on the reservoir closed until it locks securely.

Checking the coolant level when a warning message appears on the multi-function display in the instrument panel

Warning!

Danger of serious personal injury or death from scalding. Coolant is hazardous to your health, and may be fatal if swallowed.

- ▷ Do not open the cap of the expansion tank while the engine is hot.
- ▷ Allow the engine to cool down before opening the cap and protect your hands, arms and face from any possible escape of hot coolant.
- ▷ Keep coolant out of children's reach.
- ▷ Also, keep coolant away from your pets. They can be attracted to it should there be a spill, or to used coolant left in an open container. Coolant can be deadly to pets if consumed.

1. If the engine is hot, cover the reservoir cap with a cloth.
Open cap carefully and allow any overpressure to escape.
Then unscrew cap completely.
2. Read off the engine coolant level.
Top up with coolant if necessary.
Only add a mixture of antifreeze and water in equal parts.
Antifreeze in coolant:
50 % provides antifreeze protection down to $-31\text{ }^{\circ}\text{F}$ ($-35\text{ }^{\circ}\text{C}$).
Do not top up over the plus marking.

3. Screw the cap on the reservoir closed until it locks securely.
4. Have the cooling system checked.
Please contact a qualified specialist workshop.
We recommend that you have an authorized Porsche dealer to do this work as they have trained workshop personnel and the necessary parts and tools.

Maintenance notes

If pure water is added in an emergency, the mixing ratio will have to be corrected.
A significant loss of coolant indicates a leak in the cooling system.

- ▷ The cause must be eliminated without delay.
Please contact a qualified specialist workshop.
We recommend that you have an authorized Porsche dealer to do this work as they have trained workshop personnel and the necessary parts and tools.

Radiator fans

The radiators and radiator fans are in the front of the vehicle.



Warning!

Risk of injury.
The fans can start running when a certain temperature is reached, even with the engine switched off.

- ▷ Exercise extreme care when working close to the radiator fans and make sure the engine is switched off.



Brake Fluid

Regular checking of the brake fluid is part of servicing.

The fluid level should always be between the MIN and MAX markings.

A slight decrease in the fluid level due to wear and automatic readjustment of the disc brakes is normal.

However, if the fluid level falls significantly or goes below the MIN marking, the brake system may have developed a leak.

- ▷ Have the brake system checked immediately.
Please contact a qualified specialist workshop.
We recommend that you have an authorized

Porsche dealer to do this work as they have trained workshop personnel and the necessary parts and tools.

Warning!

Brake fluid is hazardous to your health, and may be fatal if swallowed. Brake fluid also attacks paintwork.

- ▷ Keep brake fluid out of children's reach.
- ▷ Immediately rinse off spilled brake fluid with clean water.
- ▷ If brake fluid gets into your eye, immediately rinse with clean water for a few minutes. Then see a doctor immediately.
- ▷ Please note all the information on the refill container of the brake fluid.

Changing brake fluid

Brake fluid absorbs moisture from the air over time. The absorbed water can impair braking efficiency.

- ▷ It is important therefore to have the brake fluid changed in accordance with the change intervals specified in the "Maintenance" booklet.

BRAKE Brake warning light USA

(!) Brake warning light Canada

The warning light on the instrument panel and the warning message on the multi-function display alert you to the fact that the brake fluid level is too low and could indicate brake circuit failure if the pedal travel is greater than normal.

Note on operation تلفن شبانه روزی: ۰۸۵ ۱۱۱۶۲

If the warning light and warning message appear when driving:

- ▷ Stop immediately in a suitable place.
- ▷ Do not continue driving. Please contact a qualified specialist workshop. We recommend that you have an authorized Porsche dealer to do this work as they have trained workshop personnel and the necessary parts and tools.

S91-233

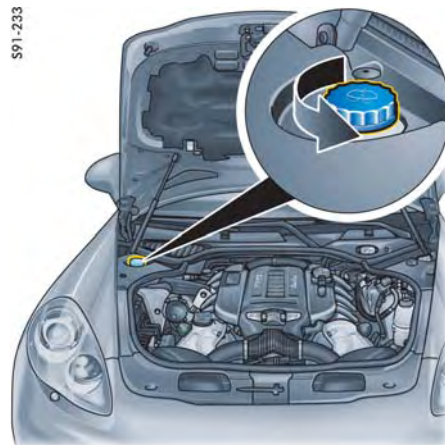

Washer Fluid

We recommend window cleaner concentrates approved by Porsche for either summer or winter, depending on the season. Your authorized Porsche dealer will be pleased to advise you.

The washer fluid reservoir for windshield, rear window and headlights is located at the rear left in the engine compartment (blue screw cap).



Warning light and warning message

The warning light on the instrument panel and the warning message on the multi-function display alert you to the fact that the washer fluid level is too low.

- ▷ Add washer fluid at the next opportunity.

In this case, the remaining quantity is only approx. 1 litre. The maximum filling capacity is approx. 5.8 US quarts (5.5 liters).

Adding washer fluid

1. Open cap on washer fluid reservoir.
2. Add washer fluid.
3. Close cap carefully.

Power Steering



Warning!

Risk of accidents. When the engine is stationary (e.g. when on tow) or the hydraulic system fails, there is no power steering assistance available.

Therefore, substantially more force will have to be exerted to steer the vehicle.

- ▷ Exercise extreme care when your vehicle is being towed.
- ▷ Have the fault corrected. Please contact a qualified specialist workshop. We recommend that you have an authorized Porsche dealer to do this work as they have trained workshop personnel and the necessary parts and tools.

Regular checking of hydraulic fluid is part of servicing. تلفن شبانه روزی: ۰۸۵ ۸۸۸۶۱۰۸۵

The flow noise heard at full steering lock is design-related and does not indicate a defect in the steering system.

Vehicles with Porsche Dynamic Chassis Control (PDCC)

If the fluid level is too low, the message “Check steering oil level” will appear on the multi-function display.

- ▷ Have the fluid level checked immediately.
- ▷ Please contact a qualified specialist workshop. We recommend that you have an authorized Porsche dealer to do this work as they have trained workshop personnel and the necessary parts and tools.

Changing Air Cleaner

Regular replacement of the filter element is part of servicing.

- ▷ In dusty conditions, clean the filter element more frequently and replace it if necessary.
- ▷ Please see the chapter “EXERCISE EXTREME CAUTION WHEN WORKING ON YOUR VEHICLE” on page 252.

Changing Particle Filter

Regular replacement of the filter is part of servicing.

A dirty filter can be the cause of reduced air throughput in your air conditioning system.

- ▷ Have the filter replaced.
Please contact a qualified specialist workshop. We recommend that you have an authorized Porsche dealer to do this work as they have trained workshop personnel and the necessary parts and tools.

Note on operation

The particle filter ensures that the fresh air entering the passenger compartment is virtually free of dust and pollen.

- ▷ If the outside air is polluted by exhaust fumes, press the recirculated-air button.

Wiper Blades

Maintenance notes

Wiper blades that are in perfect condition are vital for a clear view.

- ▷ Have the wiper blades replaced twice per year (before and after the cold season) or if wiper performance deteriorates or the blades are damaged.
- ▷ Please see the chapter “CAR CARE INSTRUCTIONS” on page 269.



Risk of damage if the wiper arm accidentally falls back onto the windshield.

- ▷ Always hold the wiper arm securely when replacing the wiper blade.

Risk of damage if wiper blades that are frozen in place are loosened improperly.

- ▷ Thaw the wiper blades before loosening them.
- ▷ Clean the wiper blades with window cleaner at regular intervals, especially after washing the vehicle in a car wash. We recommend Porsche window cleaner. If the wiper blades are very dirty (e.g. soiled with insect remains), they can be cleaned with a sponge or cloth.

If the wiper blades rub or squeak, this may be due to the following:

- If the vehicle is washed in an automatic car wash, wax residues may adhere to the windshield. These wax residues can be removed only by using window cleaner concentrate.
- The wiper blades may be damaged or worn.
- ▷ Have damaged wiper blades replaced immediately.
- ▷ Please see the chapter “WASHER FLUID” on page 259.
Contact your authorized Porsche dealer for more information.

Replacing wiper blades

- ▷ Please read the separate instructions provided by the wiper blade manufacturer.
- ▷ We recommend that you have your authorized Porsche dealer to replace the wiper blades.



Risk of damage. If a wiper blade is not changed properly, it can come loose when the car is moving.

- ▷ Check whether the wiper blade is seated securely. The wiper blade must engage the wiper arm properly.

Emission Control System

In the interest of clean air

Pollution of our environment has become a problem that is of increasing concern to all of us. We urge you to join us in our efforts for cleaner air in controlling the pollutants emitted from the automobile.

Porsche has developed an emission control system that controls or reduces those parts of the emission that can be harmful to our environment. Your Porsche is equipped with such a system.

Porsche warrants the Emission Control System in your new car under the terms and conditions set forth in the Warranty Booklet.

You, as the owner of the vehicle, have the responsibility to provide regular maintenance service for the vehicle and to keep a record of all maintenance work performed. To facilitate record keeping, have the service performed by authorized Porsche dealers. They have Porsche trained technicians and special tools to provide fast and efficient service.

To assure efficient operation of the Emission Control System:

- ▷ Have your vehicle maintained properly and in accordance with the recommendations described in your Maintenance Booklet. Lack of proper maintenance, as well as improper use of the vehicle, will impair the function of the emission control system and could lead to damage.
- ▷ Do not alter or remove any component of the emission control system.
- ▷ Do not alter or remove any device, such as heat shields, switches, ignition wires, valves, etc., which are designed to protect your vehicle's emission control system. In addition to serious engine damage, this can result in a fire if excess raw fuel reaches the exhaust system.
- ▷ Do not continue to operate your vehicle if you detect engine misfire or other unusual operating conditions.

FarmaSOS.com

Parking



Danger of fire resulting in serious personal injury or death.

- ▷ Do not park or operate the vehicle in areas where the hot exhaust system may come in contact with dry grass, brush, fuel spill or other flammable materials.
 - ▷ If your car catches on fire for any reason, call the fire department. Do not endanger your life by attempting to put out the fire.
-

Undercoating



Danger of fire resulting in serious personal injury or death.

- ▷ Do not apply additional undercoating or rust-proofing on or near the exhaust manifold, exhaust pipes, catalytic converters or heat shields. During driving the substance used for undercoating could overheat and ignite.
-

How Emission Control Works

When an automobile engine is running, it uses energy generated through the combustion of a mixture of air and fuel. Depending on whether a car is driven fast or slowly or whether the engine is cold or hot, some of the fuel (hydrocarbons) may not be burned completely, but may be discharged into the engine crankcase or exhaust system. Additional hydrocarbons may enter the atmosphere through evaporation of fuel from the fuel tank. These hydrocarbons (HC), when released into the air, contribute to undesirable pollution.

In addition, carbon monoxide (CO) and oxides of nitrogen (NOx) contribute to engine emissions. They, too, are formed during the combustion process and discharged into the exhaust system.

To reduce these pollutants, your Porsche is equipped with a precisely calibrated fuel injection system to assure a finely balanced air/fuel mixture under all operating conditions.

Oxygen sensor

The oxygen sensor, installed in the exhaust pipe continuously senses the oxygen content of the exhaust and signals the information to an electronic control unit. The control unit corrects the air/fuel ratio, so the engine always receives an accurately metered air/fuel mixture.

Crankcase ventilation

Through crankcase ventilation, undesirable emissions from the engine crankcase are not permitted to reach the outside atmosphere. These emissions are recirculated from the crankcase to the air intake system. From here the emissions mix with the intake air and are later burned in the engine.

Catalytic converters

The catalytic converters are efficient "clean-up" devices built into the exhaust system of the vehicle. The catalytic converters burn the undesirable pollutants in the exhaust gas before it is released into the atmosphere.

The exclusive use of unleaded fuel is critically important for the life of the catalytic converters. Therefore, only unleaded fuel must be used.

The catalytic converters will be damaged by:

- push or tow starting the vehicle
 - misfiring of the engine
 - turning off the ignition while the vehicle is moving or
 - driving until the fuel tank is completely empty
 - by other unusual operating conditions.
- ▷ Do not continue to operate your vehicle under these conditions, since raw fuel might reach the catalytic converters. This could result in overheating of the converters. Federal law prohibits use of leaded fuel in this car.

Fuel Economy

Fuel economy will vary depending on where, when and how you drive, optional equipment installed, and the general condition of your car.

A car tuned to specifications and correctly maintained, will help you to achieve optimal fuel economy.

- ▷ Have your vehicle tuned to specifications. Air cleaner should be dirt free to allow proper engine "breathing". Battery should be fully charged. Wheels should be properly aligned. Tires should be inflated to the correct pressure.
- ▷ Always monitor your fuel consumption.
- ▷ Drive smoothly, avoid abrupt changes in speed as much as possible.
- ▷ Avoid jack rabbit starts and sudden stops.
- ▷ Do not drive longer than necessary in the lower gears. Shifting into a higher gear early without lugging the engine will help save fuel.
- ▷ Prolonged "warm up" idling wastes gas. Start the vehicle just before you are ready to drive. Accelerate slowly and smoothly.
- ▷ Switch off the engine if stationary for longer periods.
- ▷ Any additional weight carried in the vehicle reduces fuel economy. Always keep cargo to a minimum and remove all unnecessary items.

- ▷ Organize your trips to take in several errands in one trip.
- ▷ All electrical accessories contribute to increased fuel consumption.
- ▷ Only switch on the air conditioning when necessary.
- ▷ Do not drive with the Roof Transport System mounted unless you need it.

The EPA estimated miles per gallon (mpg) is to be used for comparison purposes, actual mileage may be different from the estimated mpg, depending on your driving speed, weather conditions and trip length. Your actual highway mileage may be less than the estimated mpg.

- ▷ Please observe all local and national speed limits.

تلفن شبانه روزی: ۰۲۱-۸۸۶۲۰۸۵

FarmaSOS.com

Operating Your Porsche in other Countries

Government regulations in the United States and Canada require that automobiles meet specific emission regulations and safety standards. Therefore, cars built for the U.S. and Canada differ from vehicles sold in other countries.

If you plan to take your Porsche outside the continental limits of the United States or Canada, there is the possibility that

- unleaded fuel may not be available;
- unleaded fuel may have a considerably lower octane rating. Excessive engine knock and serious damage to both engine and catalytic converters could result;
- service may be inadequate due to lack of proper service facilities, tools or diagnostic equipment;
- replacement parts may not be available or very difficult to get.

Porsche cannot be responsible for the mechanical damage that could result because of inadequate fuel, service or parts availability.

If you purchased your Porsche abroad and want to bring it back home, be sure to find out about shipping and forwarding requirements, as well as current import and customs regulations.

Fuel

When the ignition is on, the fuel level is displayed on the instrument panel.

- ▷ Please see the chapter "FUEL GAUGE" on page 111.



Warning!

Fuel is highly flammable and harmful to health.

- ▷ Fire, open flame and smoking are prohibited when handling fuel.
- ▷ Avoid contact with skin or clothing, since injury to your skin may occur.
- ▷ Do not inhale fuel vapors, since they may make you ill and possibly cause death if inhalation is prolonged and occurs in a closed space.

To prevent damage to the emission control system and engine:

- ▷ Never drive the tank dry.
 - ▷ Avoid high cornering speeds after the warning lights have come on.
-
- ▷ Please see the chapter "FUEL ECONOMY" on page 264.

To avoid permanent damage to the functionality of the catalytic converters and oxygen sensors, use **unleaded fuel only**.

The engine is designed to provide optimum performance and fuel consumption if **unleaded premium fuel with 98 RON/88 MON** is used.

If unleaded fuels with octane ratings of **less than 98 RON/88 MON** are used, the engine's knock control automatically adapts the ignition timing. Porsche recommends that you use fuel with **at least 95 RON/85 MON** in your vehicle.

The emission control system can be damaged in various ways (e.g. fueling incorrectly, shortage of fuel, tow-starting).

- ▷ Please see the chapter "HOW EMISSION CONTROL WORKS" on page 263.

تلفن شبانه روزی: ۰۲۱-۸۸۸۶۲۰۸۵

FarmaSOS.com

Note on operation

Information on the fuel quality can normally be found on the pump. If this is not the case, ask a fuel station attendant.

If the recommended fuel is not available, you can also use unleaded regular fuel (91 RON/82.5 MON) in an emergency.

However, this could reduce performance and increase fuel consumption.

- ▷ Avoiding driving at full throttle.

In some countries the available fuel quality may not meet requirements and can result in coking around the inlet valve.

In this case, the fuel may be mixed with the additive sold and recommended by Porsche after consulting a authorized Porsche dealer.

Porsche part number 000 043 206 89.

- ▷ Observe the instructions and mixture ratios stated on the container.

It is important that the service intervals, particularly the oil change intervals, are observed in accordance with the specifications in the "Maintenance" booklet.

Refuelling



The RF energy from a cellphone can cause a sparking on bare metal, much like aluminum foil in a microwave oven. The spark could ignite gasoline fumes present while refueling. Static discharge from your body can ignite gasoline fumes present when you get back out of the vehicle and touch the fuel nozzle. In either case, resulting fire can cause serious damage to the vehicle, serious injury or death to persons in immediate vicinity.

- ▷ Do not use a cellphone while pumping gas.
- ▷ Do not re-enter the vehicle while pumping gas.

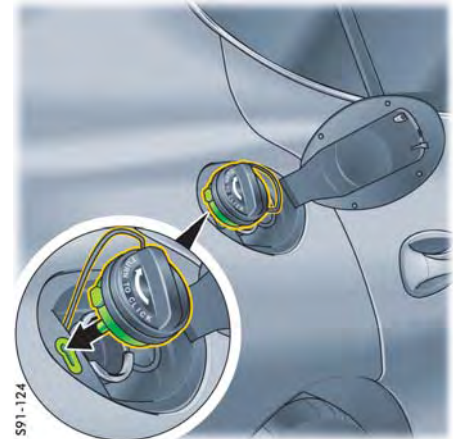

1. Stop the engine and switch off the ignition.
2. Open the filler flap by pressing on the rear part of the filler flap (**arrow**). The vehicle must be unlocked.
3. Slowly open and remove the tank cap. Put the tank cap into the holder (**arrow**).
4. Add the fuel additive recommended by Porsche if necessary.
5. Insert the pump nozzle fully into the filler neck. The handle of the pump nozzle must point downwards.
Total capacity:
Panamera S: approx. 21.14 US gallons (80 liters).
Panamera 4S/Panamera Turbo: approx. 26.42 US gallons (100 liters). The reserve is approx. 3.96 US gallons (15 liters) for each.

FarmaSOS.com

6. Operate the pump nozzle and refuel the vehicle.
Do not add further fuel once the correctly operated automatic pump nozzle has switched off. Fuel could spray back or could flow over when heated.
7. Replace the tank cap immediately after refuelling and close it until you hear and feel it locking.
8. Close the filler flap and press on the rear of the filler flap until it engages securely.

If you lose the tank filler cap, you must replace it only with an original part.

! Caution!

Risk of damage. Decorative foils may fade if they come into contact with fuel.

- ▷ Wipe off any spilled fuel immediately.

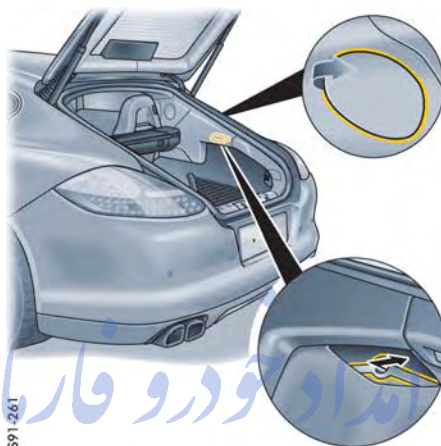

Emergency unlocking of the filler flap

If the electrical unlocking mechanism is faulty, the filler flap can be opened as follows:

- Pull the emergency release mechanism behind the right luggage compartment trim panel in **direction of arrow**.
The filler flap pops open.

Fuel Can

! Danger!

Risk of fire or explosion if the fuel can is damaged in an accident and fuel escapes. Escaping vapors can be harmful to health.

- ▷ Do not carry a fuel can on journeys.
- ▷ Observe the relevant laws.

Fuel Recommendations

Your Porsche is equipped with catalytic converters and must use **UNLEADED FUEL ONLY**.

Your engine is designed to provide optimum performance and fuel economy using unleaded premium fuel with an octane rating of **98 RON (93 CLC or AKI)**. Porsche therefore recommends the use of these fuels in your vehicle.

Porsche also recognizes that these fuels may not always be available. Be assured that your vehicle will operate properly on unleaded premium fuels with octane numbers of at least **95 RON (90 CLC or AKI)**, since the engine's "Electronic Oktane™ knock control" will adapt the ignition timing, if necessary.

It is important to observe the regular service intervals, and particularly the oil change intervals, specified in the "Maintenance" booklet.

The use of UNLEADED FUEL ONLY is critically important to the life of the catalytic converters. Deposits from leaded fuels will ruin the converters and make them ineffective as an emission control device.

Cars with catalytic converters have a smaller fuel tank opening, and gas station pumps that dispense unleaded fuel have smaller nozzles. This will prevent accidental pumping of leaded fuel into cars with catalytic converters.

Unleaded fuels may not be available outside the continental U.S. and Canada. Therefore, we recommend you do not take your car to areas or countries where unleaded fuel may not be available.

Octane ratings

Octane rating indicates a fuel's ability to resist detonation. Therefore, buying the correct octane gas is important to prevent engine "damage".

The RON octane rating is based on the research method. The CLC (U.S. Cost of Living Council octane rating) or AKI (antiknock index) octane rating usually displayed on U.S. fuel pumps is calculated as research octane number plus motor octane number, divided by 2, that is written as:

$$\frac{\text{RON} + \text{MON}}{2} \quad \text{or} \quad \frac{\text{R} + \text{M}}{2}$$

تلفن شبانه روزی: ۰۲۵-۳۸۸۶۲۰۳

The CLC or AKI octane rating is usually lower than the RON rating:

For example: 95 RON equals 90 CLC or AKI.

Fuels containing ethanol

Do not use any fuels containing more than 10 percent ethanol by volume.

We recommend, however, to change to a different fuel or station if any of the following problems occur with your vehicle:

- Deterioration of driveability and performance.
- Substantially reduced fuel economy.
- Vapor lock and non-start problems, especially at high altitude or at high temperature.
- Engine malfunction or stalling.

Fuel Evaporation Control

Fuel tank venting

The evaporation chamber and the carbon canister prevent fuel vapors from escaping to the atmosphere at extreme high outside temperatures, when driving abruptly around curves and when the car is parked at an incline or in any other nonlevel position.

Vapor control system and storage

When the fuel tank is filled, vapors are collected in the evaporation chamber by a vent line leading the vapors to the carbon canister where they are stored as long as the engine does not run.

Purge system

When the engine is running, the fuel vapors from the canister will be mixed with fresh air from the ambient air of the canister. This mixture will be directed to the intake air housing by the tank vent line, mixed with the intake air and burned during normal combustion.

Car Care Instructions

- ▷ Please see the chapter “EXERCISE EXTREME CAUTION WHEN WORKING ON YOUR VEHICLE” on page 252.

Regular and correct care helps to maintain the value of your car and is also a precondition for the New Vehicle Warranty and the Anti Corrosion Warranty.

Your authorized Porsche dealer has specially developed car-care products from the Porsche program available either singly or as complete car-care sets. They will be pleased to help you select suitable products.

Whether you use Porsche products or other commercially available cleaning agents first make sure of their correct application.

A Porsche that is well-cared for can look like new for years. It all depends on the amount of care the owner is willing to give the car.

FarmaSOS.com

Warning!

Risk of serious personal injury or damage to the vehicle or property.

Cleaning agents may be hazardous to your health.

Most chemical cleaners are concentrates which require dilution. High concentrations might cause problems ranging from irritation to serious injury as well as damage to your vehicle.

- ▷ Keep cleaning agents out of reach from children.
- ▷ Observe all caution labels.
- ▷ Always read directions on the container before using any product. These directions may contain information necessary to avoid personal injury.
- ▷ Do not use fuel, kerosene, naphtha, nail polish remover or other volatile cleaning fluids. They may be toxic, flammable or hazardous in other ways. Only use spot removing fluids in a well vented area.
- ▷ Do not clean the underside of chassis, fenders, wheel covers, etc., without protecting your hands and arms as you may cut yourself on sharp-edged metal parts.

High-pressure cleaning equipment



Warning!

High-pressure cleaning equipment can damage the following components:

- Tires
- Logos, emblems, decorative foils
- Painted surfaces
- Alternator, valve covers
- ParkAssist sensors
- Radar sensor for adaptive cruise control
- Rearview camera
- ▷ Always read the operating instructions provided by the equipment manufacturer.
- ▷ Always cover the lid of the brake fluid reservoir prior to cleaning. Never point the cleaning jet directly at the lid.
- ▷ When cleaning with a flat-jet nozzle or a so-called “dirt blaster”. maintain a minimum distance of 20 in. (50 cm).
- ▷ Never use high-pressure cleaning equipment with a round-jet nozzle.
A high-pressure cleaning device fitted with a round nozzle will damage your vehicle. The tires are particularly susceptible to damage.
- ▷ Do not point the cleaning jet directly at any of the aforementioned components.

Decorative film



Caution!

Risk of damage due to separation of the decorative film when using high-pressure cleaning equipment.

- ▷ When cleaning components, the water must not be hotter than 140 °F (60 °C) and the pressure no greater than 580 psi (40 bar). Always observe a minimum distance of 20 in. (50 cm).

Care of door lock

- ▷ To prevent the door lock from freezing during the cold season, cover the lock barrel with suitable adhesive tape while washing the vehicle.

If the lock still freezes, use an ordinary de-icer. In many cases, a well warmed key can help. Never use excessive force.

FarmaSOS.com

Car washing

The best protection for the vehicle from the damaging effects of the environment is frequent washing and preservation.

The longer road salt, road dust, industrial dust, insect remains, bird excrement, and tree sap, resin, pollen, etc. are allowed to remain on the bodywork, the more harmful their effect.

Observe the following points in order to ensure that the vehicle is washed thoroughly without damaging the paintwork:

- ▷ The underside of the vehicle should also be thoroughly washed at the end of the winter season at the latest.
- ▷ Wash your vehicle only at sites provided for this purpose to prevent soot, grease, oil and heavy metals from entering the environment.
- ▷ Dark colors are slightly more susceptible to scratching and require particularly careful paint care.
Dark paints make even the smallest surface blemishes (scratches) more conspicuous than lighter colors.
- ▷ Do not wash your Porsche in direct sunlight or when its body is hot.
- ▷ When washing by hand, use a car shampoo, plenty of water, and a soft sponge or washing brush.
We recommend Porsche car shampoo.

- ▷ Start washing the vehicle by thoroughly wetting the paintwork and rinsing the heavy dirt off.
- ▷ After washing the vehicle, rinse it thoroughly with water and rub it dry with chamois-leather. Do not use the same chamois for rubbing dry as you use for cleaning the windshield and windows.

Warning!

Risk of accidents! Reduced or uneven braking action may be caused by wet brakes.

- ▷ After washing the vehicle, test the brakes and steering and briefly brake the discs dry. When doing so, make sure that vehicles travelling behind you are not affected.

Cleaning in car washes

Optional add-on parts or parts that project beyond the contours of the vehicle may be damaged by design features of car washes.

The following parts are particularly at risk:

- Windshield wipers and rear wiper (always switch them off – wiper stalk in position **O** – to prevent them wiping unintentionally in intermittent or sensor operation).
- Exterior mirrors (always fold in).
- External antenna (always unscrew).
- Roof transport system (always remove completely).
- Spoiler.
- Wheels (the wider the rim and the lower the tire height, the greater the risk of damage).
- ▷ Please consult the operator before using automatic car washes.
- ▷ All parts not reached by a car wash, such as door and lid seams or door sills, must be washed and polished by hand.

Paint care

In order to protect the paint on your vehicle in the best possible way against mechanical and chemical damage, you should

- preserve it regularly,
- polish it if necessary,
- remove spots and stains, and
- repair damaged paintwork.

General Notes

- ▷ Never rub a dusty vehicle with a dry cloth, because the grains of dirt will damage the paintwork.
- ▷ Do not treat matt-painted components with preservatives or polishes as these remove the matt effect.

Preservation

The paint surface becomes dull over time due to weathering.

- ▷ Preserve paint regularly.
- ▷ Apply paint preservative after washing the vehicle and polish it smooth to preserve the paintwork.

This keeps the paint shiny and elastic. Dirt is prevented from adhering to the paint surface and industrial dust is prevented from penetrating the paint.

Polishing

Only when the original shine can no longer be obtained using preservatives should paint polish be used to clean the paint.

We recommend Porsche paint polish.

Removing spots and stains

- ▷ Remove tar spatters, traces of oil, insects etc. as soon as possible using an insect remover, as they discolor the paint if left to work on it over time.
- ▷ Wash the treated areas carefully afterwards.

Repairing minor paint damage

- ▷ Have minor paint damage (cracks, scratches or stone damage) repaired immediately **before** corrosion begins. Please contact a qualified specialist workshop. We recommend that you have an authorized Porsche dealer to do this work as they have trained workshop personnel and the necessary parts and tools.

If traces of corrosion have already formed, these must be thoroughly removed. An anti-corrosion primer must then be applied to these spots, followed by top-coat paint.

Paint data can be found on the vehicle data carrier.

- ▷ Please see the chapter “VEHICLE DATA BANK” on page 323.

Cleaning the engine compartment



Risk of damage, e.g. to the alternator, painted surfaces, and the valve covers.

- ▷ Never use high-pressure cleaners with a round-jet nozzle.
- ▷ Always observe a minimum distance of 20 in. (50 cm).
- ▷ Always cover the lid of the brake fluid reservoir prior to cleaning with a high-pressure cleaner. Never point the cleaning jet directly at the lid.
- ▷ Do not point the cleaning jet directly at any of the aforementioned components.

Note on operation

If the vehicle is driven frequently on salted or gritted roads:

- ▷ Have the engine compartment cleaned regularly.

Cleaning windows

- ▷ Clean all windows regularly, inside and out, with window cleaner. We recommend Porsche window cleaner.
- ▷ Do not use the same chamois for painted surfaces and for drying the windows. Preservative residues could reduce transparency.
- ▷ Remove insect residues with insect remover.

Note

The front side windows have a water-repellent (hydrophobic) coating, which prevents soiling of the windows.

This coating is subject to natural wear and can be renewed.

- ▷ Please contact a qualified specialist workshop. We recommend that you have an authorized Porsche dealer to do this work as they have trained workshop personnel and the necessary parts and tools.

Care of windshield wiper blades

Windshield wiper blades that are in perfect condition are vital for a clear view.

- ▷ Please see the chapter “WIPER BLADES” on page 261.
- ▷ Have the wiper blades replaced twice per year (before and after the cold season) or if wiper performance deteriorates or the blades are damaged.
- ▷ Clean the wiper blades with window cleaner at regular intervals, especially after washing the vehicle in a car wash.
We recommend Porsche window cleaner. If wiper blades are very dirty (e.g. covered with insect remains), they can be cleaned with a sponge or cloth.

If the wiper blades rub or squeak, this may be due to the following:

- If the vehicle is washed in an automatic car wash, wax residues may adhere to the windshield. These wax residues can be removed only by using window cleaner concentrate.
- ▷ Please see the chapter “WASHER FLUID” on page 259.

Contact your authorized Porsche dealer for more information.

- The wiper blades may be damaged or worn.
- ▷ Have damaged wiper blades replaced immediately.

Undercoating

The underside of your car is durably protected against chemical and mechanical influences.

As it is not possible to exclude the risk of damage to this protective coating in day to day driving, it is advisable to have the underside of the car inspected at certain intervals - preferably before the start of winter and again in spring - and the undercoating restored as necessary.

Your authorized Porsche dealer is familiar with the bodyseal treatment procedures and has the necessary equipment for applying factory approved materials. We recommend that you entrust them with such work and inspections.

Unlike conventional spray oils, undercoating and rust-proofing compounds based on bitumen or wax do not attack the sound-proofing materials applied at the factory.

Warning!

Danger of fire resulting in serious personal injury or death.

- ▷ Do not apply additional undercoating or rust-proofing on or near the exhaust manifold, exhaust pipes, catalytic converters or heat shields. During driving the substance used for undercoating could overheat and ignite.
- ▷ Before applying fresh underseal, carefully remove deposits or dirt and grease. Once it has dried, the new undercoating compound forms a tough protective coating which provides efficient rust-proofing of the floor panels and components.
- ▷ Always apply a fresh coating of suitable preservative to unprotect areas after cleaning the underside of the body, the transmission, the engine or carrying out repairs to under-body, engine or transmission components.

Effective rust-proofing is particularly important during the cold weather season. If your car is driven frequently in areas where salt has been spread on the roads, the whole engine compartment should be cleaned thoroughly after the winter to prevent salt from causing any lasting damage. A full under-body wash should also be performed at the same time.

Cleaning headlights, lights, interior and exterior plastic components, adhesive foils, radar sensor for adaptive cruise control and rearview camera

Observe the following points:

- ▷ Use **only** clean water and a little dishwashing liquid or interior window cleaner to clean headlights, lights, plastic components and surfaces.
Use a soft sponge or a soft, lint-free cloth.

Note

An interior window cleaner can also be used to clean plastic surfaces (always read the cleaning instructions on the container!).

We recommend Porsche interior window cleaner.

- ▷ Gently wipe the surface without applying too much pressure.
- ▷ Do not clean when dry.
- ▷ Never use other chemical cleaners or solvents.
- ▷ Rinse cleaned surfaces with clear water.

Alloy wheels

Metal particles (e.g. brass or copper in brake dust) must not remain too long on alloy wheels. Contact corrosion can cause pitting.

Note

Cleaners with an oxide-removing effect or wrong pH value, as are commonly used for other metals, as well as mechanical tools and products, will damage the oxide layer and are therefore unsuitable.

- ▷ **Use only cleaners for alloy wheels (pH value 9.5). Products with the wrong pH value can destroy the protective layer on the wheels.**

We recommend Porsche cleaner for light alloy rims.

- ▷ If possible, wash the wheels every two weeks with a sponge or washing brush. If the wheels are exposed to road salt, grit or industrial dust, weekly cleaning is necessary.
- ▷ Every three months, after cleaning, treat the wheels with car wax or an acid-free grease (e.g. Vaseline).
Rub the grease in well with a soft cloth.
- ▷ Please see the chapter "CLEANING IN CAR WASHES" on page 271.

! Danger!

Danger of accident resulting in serious personal injury or death if cleaning agents (e.g. wheel cleaning agents) come into contact with the brake discs. The resulting film on the brake discs can impair braking performance.

- ▷ Make sure that no cleaning agent comes into contact with the brake discs.
- ▷ If cleaning agent has come into contact with the brake discs, clean the brake discs thoroughly with a strong jet of water.
- ▷ Paying attention to any road users behind you, dry the brake discs by applying the brakes.

Stainless steel tailpipes

Stainless steel tailpipes can discolor due to soiling, strong heat and combustion residues.

The original shine can be achieved again using commercially available metal lustre paste or metal polish.

Cleaning door, roof, lid and window seals



Caution!

The lubricant coating on the inner door seals may be damaged by unsuitable cleaning and care agents.

- ▷ Do not use any chemical cleaning agents or solvents.
 - ▷ Do not use any preservative agents.
-
- ▷ Wash dirt (e.g. abrasion, dust, road salts) from all seals regularly using warm soapy water.
 - ▷ If there is a risk of frost, protect the outer door seals and lid seals against freezing into place with a suitable care product.

Leather care

The natural surface markings of leather, e.g. creases, healed scars, insect sting marks, structural differences and slight variations in shade and grain add to the attractiveness of the high-quality natural leather product.

Observe the following care instructions:



Caution!

The leather will be damaged by the use of unsuitable cleaning and care agents and by inappropriate treatment.

- ▷ Do not use caustic cleaners or hard cleaning objects!
- ▷ Perforated leather must under no circumstances get wet on its reverse side.
- ▷ Clean all types of leather regularly to remove fine dust using a soft, damp, white woollen cloth or a commercially available microfibre cloth.
- ▷ Remove heavy contamination with a leather cleaner.
Always read the instructions for use given on the containers.
We recommend the Porsche leather care product.
- ▷ Treat cleaned leather only with a leather care product.
We recommend the Porsche leather care product.

Cleaning carpet, floor mats

- ▷ Use a vacuum cleaner or a brush (not too soft) for cleaning.
- ▷ Heavy dirt and stains can be removed with a stain remover.
We recommend Porsche stain remover.

To protect carpets, the Porsche range of accessories includes mats of the correct size and with the appropriate fastening.



Warning!

Risk of an accident resulting in serious personal injury or death.

- ▷ Always check the movement of the pedals before driving and make sure that they are not obstructed by a floor mat or any other object.
- ▷ Secure the floor mat to prevent it from sliding into positions that could interfere with the safe operation of your vehicle – do not lay them loosely in the vehicle.
Your Porsche dealer will be glad to offer you floor mats of correct size including a securing possibility.

Cleaning air bag covers



Danger!

Risk of serious or fatal injury from impaired operation of the air bag system caused by incorrect cleaning.

- ▷ While it is appropriate to use normal surface cleaning methods on the interior of your vehicle, do not undertake deep cleaning of air bag-related components, such as the padded covers on the steering wheel, the underside of the instrument panel, front seats, roof pillars, roof liners and the rear interior trim panels, and around the seat backrest.
- ▷ Have your authorized Porsche dealer to clean these components.

Cleaning fabric linings

- ▷ Fabric linings on pillars, roofliner and sun blinds, etc. must be cleaned only using suitable cleaning agents or a suitable dry foam and a soft brush.

Alcantara care

Do not use leather care products to clean Alcantara.

For regular care, it is sufficient to clean the cover with a soft brush.

Strong abrasion or rubbing when cleaning will produce a lasting change to the surface.

Cleaning when lightly soiled

- ▷ Wet a soft cloth with water or a neutral soap solution and wipe off the dirt.

Cleaning when heavily soiled

- ▷ Wet a soft cloth with lukewarm water or diluted white spirit and dab the dirt from the outside in.

Cleaning the seat belts

- ▷ Use mild detergent to clean soiled belts.
- ▷ When drying, avoid direct sunlight.
- ▷ Only use suitable cleaning agents.
- ▷ Do not tint or bleach the belts. The belt fabric could be weakened, thus affecting safety.

Storing your Porsche

If you wish to keep your Porsche off the road for a lengthy period, we recommend that you contact your authorized Porsche dealer.

They will be glad to advise you about the necessary measures, e.g. corrosion prevention, care, maintenance and storage.

Further important information on laying up your Porsche can be found in other sections.

- ▷ Please see the chapter "BATTERY" on page 303.

For information on locking the vehicle when the battery is disconnected:

- ▷ Please see the chapter "NOT ALL VEHICLE DOORS ARE LOCKED" on page 36.

Minor Repairs

Exercise Extreme Caution when Working on your Vehicle	278
Tires and Wheels.....	280
Wheel Bolts	293
Flat Tire.....	293
Electrical System	296
Battery	303
External Power Supply, Jump-Lead Starting	306
Changing the Remote Control Battery	307
Replacing Bulbs	308
Headlights	308
Side Turn Signal Light.....	312
Licence Plate Lights	313
Side Marker Light.....	313
Changing Light-Emitting Diodes and Long-Life Bulbs	314
Headlight Adjustment.....	314
Towing	316
Fire Extinguisher	321

امداد خودرو فارما

تلفن شبانه روزی: ۰۲۱-۸۸۸۶۲۰۸۵

FarmaSOS.com

Exercise Extreme Caution when Working on your Vehicle



Danger!

Ignoring the following instructions may cause serious personal injury or death.

- ▷ The engine compartment of any motor vehicle is a potentially hazardous area. If you are not fully familiar with proper repair procedures, do not attempt the adjustments described on the following pages.
- ▷ Only work on your vehicle outdoors or in a well ventilated area.
- ▷ Ensure that there are no open flames in the area of your vehicle at any time when fuel fumes might be present. Be especially cautious of devices such as hot water heaters which ignite a flame intermittently.
- ▷ Before working on any part in the engine compartment, turn the engine off and let it cool down sufficiently. Hot engine compartment components can burn skin on contact.
- ▷ Be alert and cautious around the engine at all times while it is running. If you have to work on the engine while it is running, always put the parking brake on **and** put the PDK selector lever in position **P or N**.
- ▷ In particular, be very careful to ensure that items of clothing (ties, shirt, sleeves etc.), jewelry, long hair, hand or fingers cannot get

caught in the fan, belts or other moving parts. The radiator and radiator fans are in the front of the car.

The fans can start or continue running as a function of temperature, even with the engine switched off.

Carry out work in these areas only with the engine off and exercise extreme caution.

- ▷ Your Porsche is equipped with an electronic ignition system. When the ignition is on, high voltage is present in all wires connected with the ignition system; therefore, exercise extreme caution when working on any part of the engine while the ignition is on or the engine is running.
- ▷ Always support your car with safety stands if it is necessary to work under the car. The jack supplied with the car is not adequate for this purpose. Switch off level control of air suspension and height adjustment. Please see the chapter “RAISING THE VEHICLE WITH A LIFTING PLATFORM, TROLLEY JACK OR STANDARD JACK” on page 290.
- ▷ When working under the car without safety stands but with the wheels on the ground, make sure the car is on level ground, the wheels are blocked, and that the engine cannot be started. Withdraw ignition keys (switch ignition off in vehicles that have Porsche Entry & Drive).

- ▷ Do not smoke or allow an open flame around the battery or fuel. Keep a fire extinguisher close at hand.
- ▷ Incomplete or improper servicing may cause problems in the operation of the car. If in doubt about any servicing, have it done by your authorized Porsche dealer. Improper maintenance during the warranty period may affect your Porsche warranty coverage.
- ▷ Supplies of fluids, e.g. engine oil, washer fluid, brake fluid or coolant, are hazardous to your health. Keep these fluids out of children's reach and dispose of them in accordance with the appropriate regulations.
- ▷ Some countries require additional tools and special spare parts to be carried in your vehicle. Please make enquiries before driving abroad.

Note

The tools required for changing a wheel (e.g. jack, wheel bolt wrench, assembly aids) are not supplied as standard with the vehicle. Your authorized Porsche dealer will be pleased to advise you.

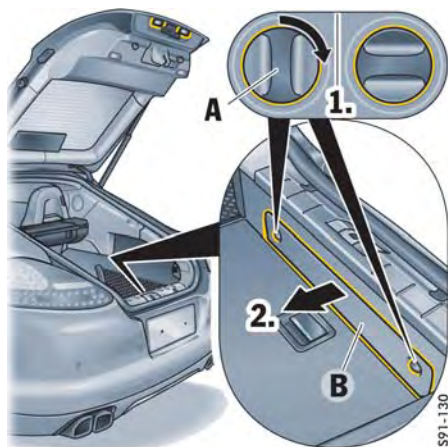

Warning triangle, first aid kit

The warning triangle, together with the first aid kit, is located in the storage compartment under the load sill in the luggage compartment.

1. Turn both twist-locks **A** 90°.
2. Remove cover **B**.

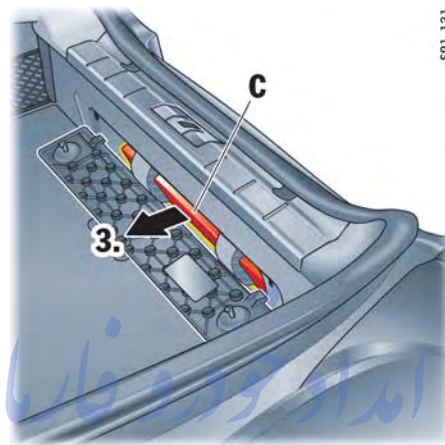

3. Remove combination pack **C** containing the first aid kit and/or warning triangle.

Note

Replace any items you remove from the first aid kit and any out-of-date items immediately.

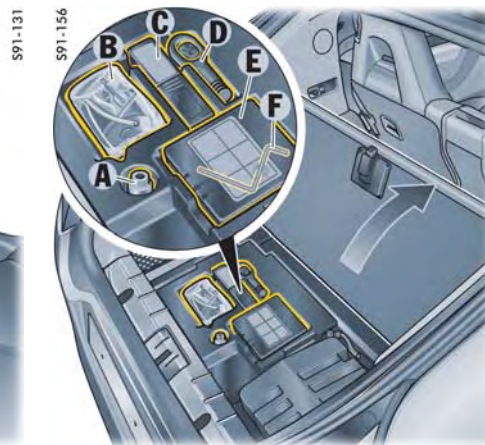

Tool kit

The tool kit is stored at the left side under the luggage compartment floor.

The tool kit contains the following:

- A Wrench socket for security wheel bolt
- B Tire sealant
- C Tool box
- D Towing lug
- E Compressor
- F Hexagon wrench for emergency operation of slide/tilt roof (under the compressor)

Tires and Wheels

The original equipment tires and wheel rims on your Porsche comply with all applicable Federal Motor Vehicle Safety Standards.

For your safety remember the following:

- Wheel rims and wheel bolts are matched to fit your Porsche.
- If you intend to use other than original equipment wheels, be sure that they conform to Porsche specifications for your model. Only tires with the same make and with the same specification code (e.g. "NO", "N1" ...) can be mounted.
- The use of wheel rims and wheel bolts that do not meet specifications of the original factory installed equipment will affect the safe operation of your vehicle and affect warranty coverage.
- Before you plan on exchanging wheels, or snow tires already mounted on the wheel rims, consult your authorized Porsche dealer. Your dealer has the technical information necessary to advise you which wheel rims and wheel bolts are compatible with the original factory installations.

Danger!

Risk of loss of control and serious personal injury or death.

- ▷ If while driving, your vehicle experiences a sudden vibration or ride disturbance, and/or you suspect that possible damage to your tires or vehicle has occurred, you should immediately reduce your speed without excessive use of the brakes.
- ▷ Stop the vehicle as soon as possible, and inspect the tires. If you cannot determine the cause for the disturbance, have your vehicle towed to the nearest Porsche or tire dealer to have your vehicle or tire(s) inspected.
- ▷ Continuing to operate the vehicle without correction could result in a loss of control and serious personal injury.

FarmaSOS.com



Example

Uniform Tire Quality Grading

Quality grades can be found where applicable on the tire sidewall between tread shoulder and maximum section width.

All passenger car tires must conform to Federal Safety Requirements in addition to these grades.

Treadwear

The treadwear grade is a comparative rating based on the wear rate of the tire when tested under controlled conditions on a specific government test course. For example, a tire graded 150 would wear one and a half (1-1/2) times as well on the government course as a tire graded 100. The relative performance of tires depends upon the actual conditions of their use, however, and may depart significantly from the norm due to variations in driving habits, service practices and differences in road characteristics and climate.

Traction AA, A, B, C

The traction grades, from highest to lowest, are AA, A, B, and C and they represent the tire's ability to stop on wet pavement as measured under controlled conditions on specified government test surfaces of asphalt and concrete. A tire marked C may have poor traction performance.



Warning!

The traction grade assigned to this is based on braking (straight-ahead) traction tests and does not include cornering (turned) traction, acceleration, hydroplaning or peak traction characteristics.

Temperature A, B, C

The temperature grades are A (the highest), B and C, representing the tire's resistance to the generation of heat and its ability to dissipate heat when tested under controlled conditions on a specified indoor laboratory test wheel.

Sustained high temperatures can cause the material of the tire to degenerate and reduce tire life, and excessive temperature can lead to sudden tire failure.

The grade C corresponds to a level of performance which all passenger car tires must meet under the Federal Motor Vehicle Safety Standard No. 109.

Grades B and A represent higher levels of performance on the laboratory test wheel than the minimum required by law.



Warning!

The temperature grade for this tire is established for a tire that is properly inflated and not overloaded. Excessive speed, underinflation, or excessive loading, either separately or in combination, can cause heat buildup and possible tire failure, resulting loss of control, leading to serious personal injury or death.

Tire pressures



Danger!

Risk of accident.

Risk of serious personal injury or death.

Driving the vehicle with low tire pressure increases risk of a tire failure and resulting loss of control. Furthermore, low tire pressure increases rate of wear of the affected tires and cause damage.

- ▷ Always use an accurate tire pressure gage when checking inflation pressures.
- ▷ Do not exceed the maximum tire pressure listed on the tire sidewall. (Also refer to "Technical data").
- ▷ Please see the chapter "TIRE PRESSURE PLATE" on page 283.
- ▷ Cold tire inflation pressure means: all tires must be cold, ambient temperature maximum 68 °F (20 °C), when adjusting the inflation pressure. Avoid sunlight striking the tires before measuring cold pressures, since the pressures would rise from temperature influence.

- ▷ Valve caps protect the valve from dust and dirt, and thus from leakage. Always screw caps tightly down. Replace missing caps immediately.
- ▷ Use only plastic valve caps.
- ▷ For safety reasons, don't use tire inflating bottles.

▷ Please see the chapter “TIRE PRESSURE FOR COLD TIRES (68 °F/20 °C)” on page 326.

Each tire, including the spare (if provided), should be checked monthly when cold and inflated to the inflation pressure recommended by the vehicle manufacturer on the vehicle placard or tire inflation pressure label. (If your vehicle has tires of a different size than the size indicated on the vehicle placard or tire inflation pressure label, you should determine the proper tire inflation pressure for those tires).

As an added safety feature, your vehicle has been equipped with a tire pressure monitoring (TPM) that illuminates a low tire pressure telltale when one or more of your tires is significantly under-inflated. Accordingly, when the low tire pressure telltale illuminates, you should stop and check your tires as soon as possible, and inflate them to the proper pressure. Driving on a significantly under-inflated tire causes the tire to overheat and can lead to tire failure. Under-inflation also reduces fuel efficiency and tire tread life, and may affect the vehicle's handling and stopping ability.

Please note that the TPM is not a substitute for proper tire maintenance, and it is the driver's responsibility to maintain correct tire pressure, even if under-inflation has not reached the level to trigger illumination of the TPM low tire pressure tell-tale.

For further information on the tire pressure monitoring:

- ▷ Please see the chapter “TIRE PRESSURE MONITORING (TPM)” on page 127.

When tires are warm, the tire pressure is increased.

- ▷ Never let air out of hot tires. This could cause the tire pressure to fall below the prescribed value.

Insufficient tire pressure can cause tires to overheat and thus be damaged – even invisibly. Hidden tire damage is not eliminated by subsequently correcting the tire pressure.

FarmaSOS.com

Overloading



Danger!

Risk of damage to vehicle parts, loss of control and serious personal injury or death.

- ▷ Do not overload your vehicle. Be careful about the roof load.
 - ▷ If you plan to load the vehicle, first correct the tire pressure. Tire pressure for loaded vehicle can be found on the tire pressure plate and in the chapter technical data.
 - ▷ Never exceed the specified axle load. Overloading can shorten the service life of the tires and car, as well as lead to dangerous vehicle reactions and long braking distances. Damage due to overloading is not covered by the vehicle warranty. Tire damage may also be caused by overloading, and this damage is not covered by your tire warranty.
-
- ▷ Please see the chapter “LOADING INFORMATION” on page 236.

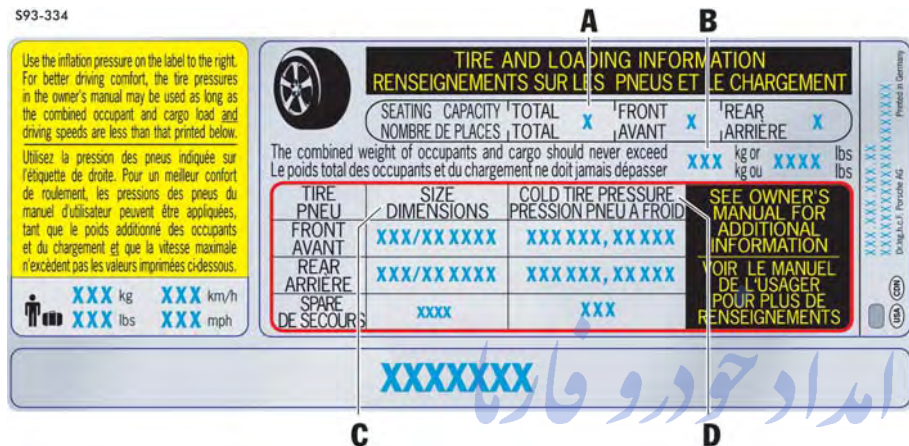

Example of a tire pressure plate

Tire Pressure plate

Information on the tire pressure plate

- A Seating capacity
Maximum number of vehicle occupants, including the driver.
- B Vehicle load limit
Is the maximum total weight limit specified of the load (passengers and cargo) for the vehicle. This is the maximum weight of passengers and cargo that can be loaded into the vehicle.
Please see the chapter "LOADING INFORMATION" on page 236.

- C Original tire size
Size of tires mounted at the factory.
- D Recommended cold tire inflation pressure
These values are for cold tires (68 °F/20 °C).

Tire traction



When driving on wet or slushy roads, a wedge of water may build up between the tires and the road. This phenomenon is known as "hydroplane" and may cause partial or complete loss of traction, vehicle control or stopping ability.

- Reduce speed on wet surfaces to prevent this.

Tire life

Tire life depends on various factors, i.e., road surfaces, traffic and weather conditions, driving habits, type of tires and tire care.

- Inspect your tires for wear and damage before driving off. If you notice uneven or substantial wear, wheels might need alignment or tires should be balanced or replaced.

Tire wear

The original equipment tires on your Porsche have built-in tire wear indicators. They are molded into the bottom of the tread grooves and will appear as approximately 1/2 in. (12 mm) bands when the tire tread depth is down to 1/16 of an in (1.6 mm).

When the indicators appear in two or more adjacent grooves, it is time to replace the tires. We recommend, however, that you do not let the tires wear down to this extent.
Worn tires cannot grip the road surface properly and are even less effective on wet roads.

In the United States, state laws may govern the minimum tread depth permissible. Follow all such laws.

Danger!

Driving on worn tires can result in loss of control of the vehicle and could cause serious personal injuries or death.

- ▷ Do not drive with worn tires or tires showing cuts or bruises as they may lead to sudden deflation and loss of control which could cause severe personal injury.
- ▷ If you notice that tires are wearing unevenly, consult your authorized Porsche dealer.

Uneven wear may not always be due to improper wheel alignment. It can be the result of individual driving habits such as cornering at high speeds. If the tire pressure is not checked and adjusted regularly, abnormal tire wear can also occur.

Tire care

- ▷ Avoid damaging tires and wheel rims.
- ▷ If you must drive over a curb or other obstacle, drive slowly and at an obtuse angle.
- ▷ Check tires for uneven wear and damage before driving off.
- ▷ Remove imbedded material.
- ▷ Replace worn or damaged tires immediately.
- ▷ Keep oil, fuel, brake fluid, etc. away from tires.
- ▷ Replace missing valve stem caps.
- ▷ Keep tires inflated correctly.
- ▷ Wash tires when washing the vehicle. Also clean inner side of wheels.
- ▷ Do not use abrasive cleaners when washing the wheels.
- ▷ Check wheel rims for corrosion.
- ▷ Remove road salt, if driving in winter.

Tire damage, puncture

- ▷ Please see the chapter “HIGH-PRESSURE CLEANING EQUIPMENT” on page 270.

Danger!

Risk of serious personal injury or death. Driving the vehicle with low tire pressure increases risk of a tire failure and resulting loss of control. Furthermore, low tire pressure increases rate of wear of the affected tires.

- ▷ Check tires – including sidewalls – regularly for foreign bodies, nicks, cuts, cracks and bulges.
 - ▷ Cross curb edges slowly and at right angles if possible. Avoid driving over steep or sharp curbs.
 - ▷ In cases of doubt, have the wheel (particularly the inner side) checked by an authorized Porsche dealer.
-

In case of tire damage, where it is uncertain whether there is a break in the ply with all its consequences or tire damage caused by thermal or mechanical overloading due to loss of pressure or any other prior damage, we recommend that the tire be replaced for safety reasons.

If one faulty tire is replaced it should be noted that the difference in tread depth on one axle must not exceed 30%. Handling inconsistencies may result.

- ▷ Perform a visual inspection if necessary.

Tire replacements

- ▷ Use only tire makes and types tested by Porsche.

If you do not use a Porsche recommended replacement tire, make sure that you purchase your new tires from a reputable tire dealer and that the dealer complies with all manufacturers warnings for those tires.

Only tires with the same manufacturer and with the same specification code (e.g. "NO", "N1"...) should be mounted on the vehicle.

Before mounting new tires, check with your Porsche dealer about the current release status.

Tires should be replaced no less than on one axle at the time. Only tires of the same make and type must be used. Mixed tires are not permissible and will affect vehicle performance, safety, and can affect vehicle warranty.

Porsche dealers can recommend the most current replacement tire options for your vehicle.

Initially, new tires do not have their full traction. You should therefore drive at moderate speeds during the first 60 - 120 miles (100 - 200 km).

Tires must always remain on the same side of the vehicle.

When wheels are removed, the direction of rotation and position of each wheel should be marked.

If new tires are installed only on **one** axle, a noticeable change in handling occurs due to the different tread depth of the other tires. This happens especially if only rear tires are replaced. However, this condition disappears as the new tires are broken in.

- ▷ Please adjust your driving style accordingly.

Installation of new tires should only be done by a qualified tire technician.

Valves

- ▷ Use only plastic valve caps.
- ▷ The rubber valves must be replaced whenever the tires are changed.
- ▷ The fitting and replacement specifications must be observed for metal valves.
- ▷ Only use Original Porsche metal valves.
- ▷ Protect the valve inserts against soiling with valve caps. Soiled valve inserts can cause a gradual loss of air.

Parking at the curb



Hard impacts against curbs (or traffic islands) are dangerous and may cause hidden tire damage which is not noticeable until later. Such damage can result in accidents at high speeds causing serious personal injury or death. Depending on the force of impact, the edge of the rim can also be damaged.

- ▷ After such an impact, have the wheel checked by an expert.
- ▷ If you must drive over a curb or other obstacle, drive slowly and at an obtuse angle. Exercise care when parking along curbs.

Maintenance note

Tire repairs are not permissible under any circumstances.

Wheel alignment, wheel balancing

As a precaution, have wheels with summer tires balanced in the spring, and those with mud and snow tires before winter. Unbalanced wheels may affect car handling and tire life. Only the specified weights may be used for wheel balancing.

Self-adhesive weights must not come into contact with cleaning agents, since they could drop off. Uneven tread wear indicates wheel imbalance. In this event, the vehicle should be checked at an authorized Porsche dealer.

 **Danger!**

If, during a trip, uneven running or vibrations occur that could be caused by damage to tires or the car, the speed must be reduced immediately, but without braking sharply. If you continue your trip without having the cause of the fault remedied, you might lose control of your vehicle which could cause serious personal injury or death.

- ▷ Stop the vehicle and check the tires.
- ▷ If no cause for the fault can be found, drive carefully to the nearest authorized Porsche dealer.

Wheels with Tire Pressure Monitoring (TPM) sensors

Before changing wheels, make sure that the wheels are compatible with your vehicle's TPM.

- ▷ Check this with your authorized Porsche dealer.

Removing and storing tires

- ▷ After changing, adjust tire pressure and torque wheel bolts diagonally. Please see the chapter "CHANGING A WHEEL" on page 291.
- ▷ Store tires in a cool and dry place. Rotate periodically to avoid flat spots.
- ▷ Avoid contact with fuel, oil and grease.

Tires must always remain on the same side of the vehicle.

When wheels are removed, the direction of rotation and position of each wheel should be marked.

Example

FR (front right), FL, RR and RL.

Wheels must always be fitted in accordance with their marking.

The perception that tire durability and performance are not affected by storage and age is unfounded.

Chemical additives, which make the rubber elastic, lose their effectiveness over the course of time and the rubber becomes brittle and cracks.

Therefore, the tires should be inspected from time to time.

Note

Under no circumstances should tires older than 6 years be used on your Porsche.

The age of the tire can be obtained from the "DOT" code number. If, for example, the last three numbers read 1208, then the tire was produced in the 12th week of 2008.

Snow tires

The installation of Porsche approved snow tires is recommended.

Use Porsche approved snow tires for grip on snow and ice.

Check with your local Motor Vehicle Bureau for possible restrictions.



Danger!

Risk of loss of control and damage to the vehicle as well as serious personal injury or death.

The standard tires profile and rubber mixture are optimized for wet and dry driving conditions, and may not prove favorable for snow conditions.

- ▷ Install snow tires before driving in such conditions.

Before mounting snow tires, consult with your Porsche dealer. They have the technical information necessary to advise you on wheel and tire compatibility.

- ▷ Snow tires should have the same load capacity as original equipment tires and should be mounted on all four wheels.



Danger!

Risk of serious personal injury or death. Driving the vehicle with low tire pressure increases risk of a tire failure and resulting loss of control. Furthermore, low tire pressure increases rate of wear of the affected tires and cause damage.

Tires with badly worn treads and studs are very dangerous and could cause accidents resulting in serious personal injuries or death.

- ▷ Make sure they are replaced immediately.

- ▷ Do not exceed the snow tire speed rating.

Snow tires do not have the same degree of traction on dry, wet or snowfree roads as normal tires.

Furthermore, snow tires wear rapidly under these conditions.

FarmaSOS.com

Maintenance note

We recommend fitting winter tires on the vehicle at temperatures below 45 °F (7 °C) since the driving performance of summer tires is reduced at low temperatures. Summer tires may be permanently damaged at extremely low temperatures.

Winter tires do not fulfill their purpose if the tread depth is less than 5/32 in. (4 mm).

Comply with all state and local laws governing snow tire and tread depth requirements.



Danger!

Risk of accident and serious personal injury or death due to excessive speed.

- ▷ Always check the maximum speed rating on the tire sidewall on any tire on the vehicle.
- ▷ Never exceed the maximum speed rating of the tires.

Wheel change

- ▷ When wheels are removed, mark the direction of rotation and position of each wheel. Example: FR (front right), FL, RR and RL.
- ▷ Always fit the wheels in accordance with the markings.

Snow chains



Warning!

Risk of damage to body, axle or brake components.

- Use only the fine-link snow chains recommended and authorized by Porsche so that sufficient clearance between the wheel well and the chain is assured.
- Please see the chapter “WHEELS, TIRES” on page 325.
- Follow instructions issued by the supplier of the chains.

Fit snow chains only on the rear axle.

- Remove spacers if snow chains are mounted.
- Before fitting chains, remove accumulated ice and snow from the wheel well.
- Vehicles with snow chains must not be driven faster than **30 mph (50 km/h)**.

Different states and countries have varying statutory requirements regarding maximum speed.

- Check with local authorities for possible restrictions.
- Remove chains as soon as the roads are free of ice and snow.

593-339

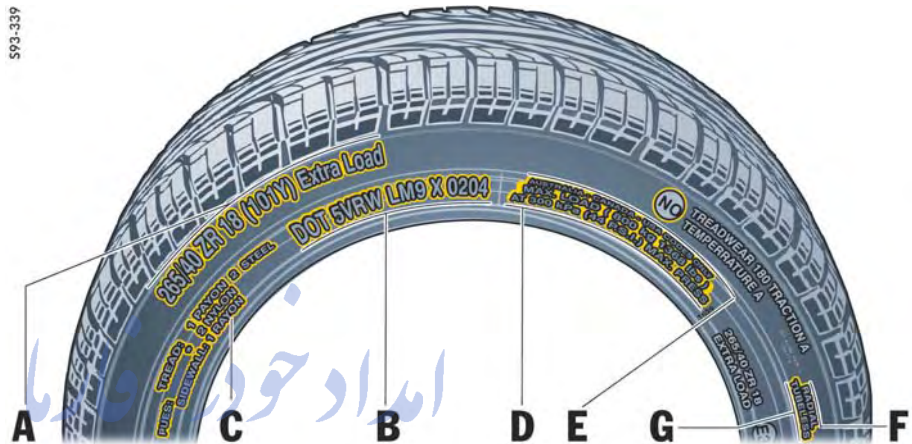

Example of Inscription

Inscription on radial tire: تلفن شبانه روزی: 0212 611 11 11

A – Tire size

Example: **P 265/40ZR18 (101Y)**

- **P** - The tire is designed for Passenger vehicle. This information is not included on all tires.
- **265** - Indication of tire width in mm
- **40** - Indication of tire height to tire width ratio in percent
- **ZR** - Belt type code letter for radial
- **18** - Indication of rim diameter in inches
- **101** - Load capacity coefficient

– **Y** - Speed code letter

– **XL (Extra Load)** - Tire with increased load rating

B – TIN (Tire Identification Number)

Example: DOT xx xx xxxx xxxx

- DOT
The DOT symbol indicates that the tires comply with the requirements of the US Department of Transportation and provides information about:
- first two-digit code means manufacture's identification mark.

- second two-digit code means tire size.
- third four-digit code means tire type code.
- fourth four-digit code means date of manufacture.
If, for example, the last four numbers read 1204, the tire was produced in the 12th week of 2004.

C – Tire ply composition and material

The number of layers in the tread and sidewalls and their material composition.

D – Maximum permissible inflation pressure

The maximum permissible cold inflation pressure to which a tire can be inflated.

- ▷ Do not exceed the permissible inflation pressure.

E – Maximum Load rating

The maximum load in kilograms and pounds can be carried by the tire. If you replace tires always use a tire that has the same maximum load rating as the factory installed tire.

F – Radial

The identification indicates if the tire has radial structure.

G – Term of tubeless or tube tire

Identification for tubeless tires.

Speed code letters

The speed code letter **Y** indicates the maximum permitted speed for the tire.
This code letter is shown on the tire sidewall.

- T** = up to 118 mph (190 km/h)
- H** = up to 131 mph (210 km/h)
- V** = up to 150 mph (240 km/h)
- W** = up to 167 mph (270 km/h)
- Y** = up to 186 mph (300 km/h)
- (Y)** = up to 186 mph (300 km/h) as for Y tires. Speeds of more than 185 mph (300 km/h) are also possible at a maximum tire load capacity of 85 % (confirmation from tire manufacturer required for speeds of more than 185 mph (300 km/h)).

Tip on driving

Tires with a maximum speed rating that is lower than the specified maximum vehicle speed may be mounted only if they bear an M+S identification on the tire sidewall.

- ▷ Please note that in addition to snow tires, all-season tires are also subject to speed limits and bear this identification.



- G** - Rim width in inches
- H** - Rim-flange contour code letter
- I** - Symbol for drop-center rim
- J** - Rim diameter in inches
- K** - Double hump
- L** - Rim offset in mm

Inscription on alloy wheels

The information is inscribed on the back of the spokes near the tire valve.

S91-126

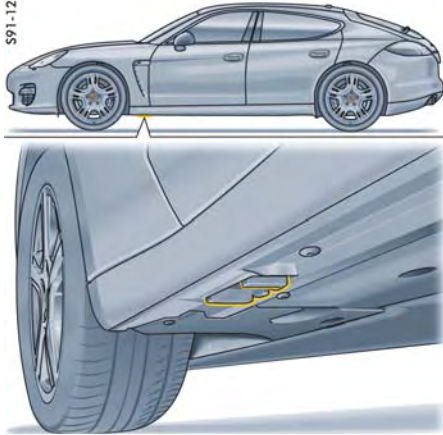

Jacking point for lifting platform and jack at the front

Raising the vehicle with a lifting platform, trolley jack or standard jack

- ▷ Before driving the vehicle onto a lifting platform, make sure that there is sufficient space between the lifting platform and the vehicle.

S91-125

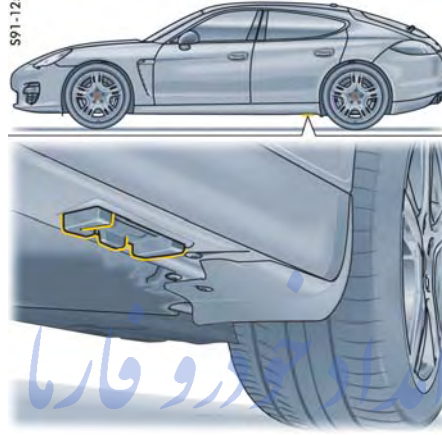

Jacking point for lifting platform and jack at the rear

Caution! تلفن شبانه روزی: ۰۸۵ ۸۸۶۲۰۸۵

Serious personal injury or death and/or serious damage to the engine or vehicle may occur, if you lift the vehicle improperly.

- ▷ Never lift the vehicle at any other place than the jacking points.
- ▷ Never lift the vehicle by the engine, transmission or axles.
- ▷ Do not damage any sensitive components in the vicinity of the jacking points.

Raising vehicles with a level control system

Switch off the automatic level control system before driving onto a lifting platform or before raising the vehicle using a lifting platform, trolley jack or standard jack.

Switching off level control

The level control system can only be switched off when the vehicle is stationary. To increase ground clearance, the vehicle should be set to High Level before switching off level control.

- ▷ Please see the chapter "PORSCHE ACTIVE SUSPENSION MANAGEMENT (PASM)" on page 208.

1. Switch on ignition.
2. Press and hold button  (for approx. 10 seconds) until the message "Control off" appears on the multi-function display.

Switching on level control

1. Lower the vehicle.
2. Switch on ignition.
3. Press and hold button  (for approx. 10 seconds) until the message "Control on" appears on the multi-function display.

Note

Level control is switched on automatically at speeds of more than 4 mph (7 km/h).

Changing a wheel



Danger!

Failure to follow these instructions may result in serious personal injury or death to you or to bystanders.

Before changing the wheel

- ▷ If you have a flat tire, move a safe distance off the road. Turn the emergency flasher on and use other warning devices to alert other motorists.
- ▷ Do not park your vehicle where it may contact dry grass, brush or other flammable materials. The hot parts of the exhaust system could set such materials on fire, thereby causing both property damage and severe or fatal physical injury.
- ▷ Passengers must not be in the vehicle when it is jacked up.
- ▷ Before you change a wheel, be sure the ground is level and firm. If necessary, use a board under the jack to ensure that the jack does not sink into the ground.
- ▷ Set the electric parking brake and block the wheels opposite the flat tire on the other side of the vehicle.

While operating the jack

- ▷ The jack is only to be used for changing a wheel. Do not use it as a support to work under the car.

- ▷ The car must be jacked up only at the illustrated jacking points. Lifting at any other place may damage the vehicle or may result in personal injury. Never jack the car up by the body or the bumpers.
- ▷ For safety reasons do not use tire inflating bottles. Do not use commercially available sealant bottles. Use only the tire inflating bottle located in the luggage compartment.

Note

The tools required for changing a wheel (e.g. jack, wheel bolt wrench, assembly aids) are not supplied as standard with the vehicle. Your authorized Porsche dealer will be pleased to advise you.

Sequence of operation



Warning!

The jack must be used only to raise the car for wheel changing. The jack must never be used as a support to work underneath the vehicle. If the jack is accidentally dislodged, you or bystanders could suffer severe personal injury.

- ▷ Never jack up other vehicles or other loads with the jack.
- ▷ Always place the car on stable supports if you have to work under it. When working under the vehicle, always use safety stands specifically designed for this purpose.

- ▷ Please use a suitable knee rest to protect your clothing against soiling.
1. Activate the electric parking brake and shift into 1st gear or move the PDK selector lever to position **P**. Remove the ignition key or control unit on vehicles with Porsche Entry & Drive.
 2. Switch on the emergency flasher if necessary.
 3. Secure the vehicle against rolling away, e.g. by means of wedges at the wheels on the opposite side. This is particularly important on slopes.
 4. Slightly loosen the wheel bolts on the wheel to be changed.
 5. Lift the vehicle only at the specified jacking points.
 6. Raise the vehicle until the wheel lifts off the ground.
- ▷ Please see the chapter "RAISING THE VEHICLE WITH A LIFTING PLATFORM, TROLLEY JACK OR STANDARD JACK" on page 290.
7. Remove 1 or 2 wheel bolts (see corresponding figure).



S91-164

Screw in one assembly aid on vehicles **without** PCCB

8. Screw in assembly aids instead of wheel bolts.

Caution!

Risk of damage to brake discs.

- ▷ Always screw in the assembly aids when changing a wheel.



S91-163

Screw in two assembly aids on vehicles **with** PCCB

9. Remove the remaining wheel bolts, تلفن شبانه ۰۲۱ ۸۸۶۲۸۸

10. Take the wheel off and put a new wheel on.

- ▷ Please see the chapter "WHEEL BOLTS" on page 293.

11. Insert wheel bolts and tighten by hand.

12. Remove assembly aids and screw in remaining wheel bolts.

Initially tighten bolts only slightly in diagonally opposite sequence so that the wheel is centered.

13. Inflate the tire if necessary.

- ▷ Please see the chapter "TIRE PRESSURE FOR COLD TIRES (68 °F/20 °C)" on page 326.

14. Lower the vehicle fully and remove the jack.

15. Tighten wheel bolts in diagonally opposite sequence.

Immediately after changing a wheel, use a torque wrench to check the prescribed tightening torque of the wheel bolts (160 Nm/118 ftlb.).

Note on operation for vehicles with Tire Pressure Monitoring

- ▷ On vehicles with Tire Pressure Monitoring, the settings on the multi-function display must be updated after the wheel change.
- ▷ Please see the chapter "TIRE PRESSURE MONITORING (TPM)" on page 127.

Wheel Bolts

- ▷ Always clean the wheel bolts before fitting.
- ▷ Wheel bolts must not be greased.
- ▷ Replace damaged wheel bolts. Only use genuine Porsche wheel bolts assigned especially to this model or wheel bolts of similar quality that have been manufactured according to Porsche specifications and production requirements.

Tightening torque

Tightening torque for wheel bolts: **160 Nm (118 ftlb.)**.



Security wheel bolts

The adapter (wrench socket) for the security wheel bolts is stored in the tool tray under the luggage compartment floor.

- ▷ If the wheels have to be removed at the workshop, do not forget to hand over the socket for the security wheel bolts along with the car key.
- ▷ To loosen or tighten the wheel bolt with anti-theft protection, the adapter must be used between the wheel bolt and the wheel bolt wrench.
- ▷ When positioning the wrench socket, ensure that it engages fully in the teeth of the wheel bolt.

S91-178

Flat Tire

1. Stop the vehicle as far away from the driving lane as possible. The vehicle must be parked on a firm and flat surface offering adequate grip.
2. Switch emergency flasher on.
3. Apply the parking brake.
4. Put the vehicle in 1st gear or move the PDK selector lever to position **P**.
5. Straighten the front wheels.
6. Remove the ignition key, or the control unit on vehicles with Porsche Entry & Drive, in order to lock the steering and prevent the engine from being started.
7. Get all passengers to leave the vehicle.
8. Set up the warning triangle at a suitable distance.

Filling in tire sealant

The tire sealant and compressor with pressure tester can be found in the tool tray under the loadspace floor in the luggage compartment.

The tire sealant can be used to seal small cuts, especially in the tire tread.

Sealing the tire with the tire sealant is only an emergency solution so you can drive to the nearest workshop. Even if the tire is air-tight,

it may only be used for short journeys in an emergency.

The tire sealant comprises:

- a filler bottle,
- a filler hose,
- a valve turner,
- a spare valve insert,
- a sticker with the maximum permitted speed
- a compressor and
- instructions for use.

! Danger!

Risk of accident, resulting in serious personal injury or death.

- ▷ Use the tire sealant only in the case of cuts or punctures no larger than 0.15 in. (4 mm).
- ▷ Never use the tire sealant if the rim is damaged.

! Warning!

The sealant is highly flammable and potentially fatal if inhaled.

- ▷ Fire, naked flame and smoking are prohibited when handling tire sealant.
- ▷ Avoid contact with skin, eyes, and clothing due to caustic chemical properties of the tire sealant.
- ▷ Keep tire sealant away from children.
- ▷ Do not inhale vapours, due to the consequent harm to personal health resulting in serious personal injury or death.

In the event of contact with sealant:

- ▷ If sealant gets on your skin or into your eyes, thoroughly rinse the affected part of your body immediately with plenty of water.
- ▷ Change soiled clothing immediately.
- ▷ See a doctor immediately in the event of an allergic reaction.
- ▷ If sealant is swallowed, thoroughly rinse out the mouth without delay and drink plenty of water. Do not induce vomiting. See a doctor immediately.

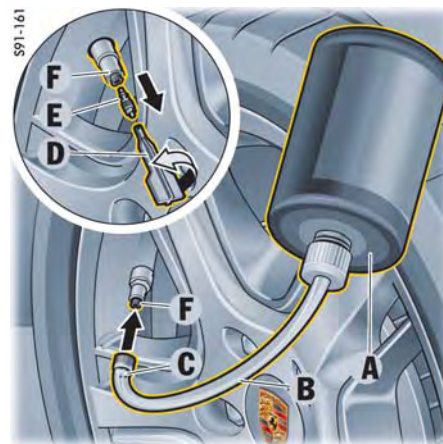

- A** - Filler bottle
- B** - Filler hose
- C** - Filler hose plug
- D** - Valve turner
- E** - Valve insert
- F** - Tire valve

Filling in sealant

1. Leave the object that caused the puncture in the tire.
2. Remove sealant and the enclosed sticker from the luggage compartment.
3. Stick the sticker in the driver's field of vision.
4. Shake filler bottle **A**.

5. Screw filler hose **B** onto the filler bottle.
The filler bottle is now open.
6. Unscrew valve cap from the tire valve **F**.
7. Remove valve insert **E** from the tire valve with valve turner **D**.
Keep the valve insert in a clean, dry place.
8. Remove plug **C** from the filler hose **B**.
9. Push filler hose onto the tire valve.
10. Hold the filler bottle higher than the level of the tire valve and squeeze it forcefully until the bottle is completely emptied into the tire.
11. Pull filler hose off the tire valve.
12. Twist the valve insert firmly into the tire valve using the valve turner.
13. Connect the compressor to a vehicle plug socket and inflate the tire to at least 37 psi (2.5 bar).
If this tire pressure cannot be reached, the tire is too severely damaged. You must not continue driving with this tire.
14. Screw valve cap onto the tire valve.

15. After driving for approx. 10 minutes, check the tire pressure.
If the tire pressure is less than 22 psi (1.5 bar), do not continue driving.
If a value of more than 22 psi (1.5 bar) is indicated, correct the pressure to the prescribed value.

- ▷ Please see the chapter "TIRE PRESSURE FOR COLD TIRES (68 °F/20 °C)" on page 326.

16. Please contact a qualified specialist workshop. We recommend that you have an authorized Porsche dealer to do this work as they have trained workshop personnel and the necessary parts and tools.

- ▷ Please also make sure to follow the separate instructions for use for the tire sealant.

Note on operation for vehicles with Tire Pressure Monitoring

- ▷ The settings for Tire Pressure Monitoring must be updated on the multi-function display after filling the tire with sealant.
- ▷ Please see the chapter "OVERVIEW OF WARNING MESSAGES" on page 152.

Care instructions

After drying, any sealant that emerges can be peeled off like a film.



Risk of accidents, resulting in serious personal injury or death.

- ▷ Have the tire replaced by a specialist workshop as soon as possible. Inform the specialist workshop that the tire contains sealant.
 - ▷ Avoid hard acceleration and high cornering speeds.
 - ▷ Observe the maximum speed of 50 mph (80 km/h).
 - ▷ Always observe the safety and operating instructions, which can be found in the separate operating instructions for the sealant and on the compressor.
-

Electrical System

In order to avoid damage and faults in electrical or electronic systems, electrical accessories should be installed at a qualified specialist workshop. We recommend that you have an authorized Porsche dealer to do this work, as they have the trained workshop personnel and the necessary parts and tools for this type of work.

- ▷ Use only accessories approved by Porsche.

Warning!

Risk of short circuit and fire, resulting in serious personal injury or death. Replacing fuses or relays with the engine running or the ignition on could cause electrical shock.

- ▷ Disconnect the negative terminal on the battery during all work on the electrical system.
- ▷ Please see the chapter "BATTERY" on page 303.

Relays

Relays should be checked or changed only at an authorised workshop.

تلفن شبانه روزی: ۰۲۱-۸۸۸۶۲۰۸۵

FarmaSOS.com

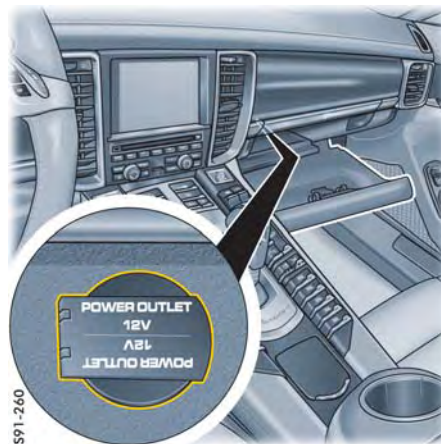

Plug socket in glove compartment

Sockets

Electrical accessories can be connected to the 12 V sockets.

You will find sockets in the glove box, in the front and rear center consoles and in the luggage compartment, depending on vehicle equipment.



Plug socket in the storage tray between the front seats

Note

The maximum electrical load of a socket is 20 A, but only if no other loads are switched on. Do not exceed 10 A per socket if several loads are operating simultaneously.



Plug socket in the storage tray between the rear seats

Note on operation

The sockets and thus the connected electrical accessories function even if the ignition is switched off or the ignition key is removed.

If the engine is not running and the accessories are switched on, the vehicle battery will be discharged.

The power supply is interrupted after 30 minutes to protect the vehicle battery. The ignition must then be switched on once in order to switch the load back on again.

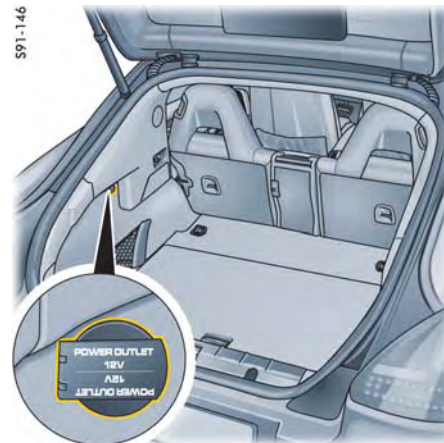

Plug socket in the luggage compartment

Plug sockets in the storage tray of the large center console in the rear of the vehicle

Two additional plug sockets are located in the storage tray of the large center console in the rear of the vehicle, if the relevant vehicle equipment is fitted.

Changing fuses

In order to prevent damage to the electrical system due to short circuits and overloads, the individual circuits are protected by fuses.

One fuse box is located in the luggage compartment. Two additional fuse boxes are located in the outer ends of the dashboard.

1. Switch off the load with the defective fuse.
2. Open the fuse box cover.
3. Remove the corresponding fuse from its slot using the plastic gripper **D** in order to check it. A blown fuse can be identified by the melted metal strip.
4. Replace only with fuses of the same rating. We recommend that you use genuine Porsche fuses for replacement.

Note

- ▷ If a fuse blows repeatedly: Please contact a qualified specialist workshop. We recommend that you have an authorized Porsche dealer to do this work as they have trained workshop personnel and the necessary parts and tools.

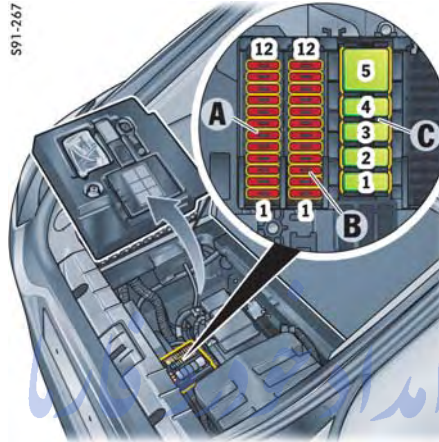

- A - Fuse carrier
- B - Fuse carrier
- C - Relay carrier

Opening fuse box and relay box cover in luggage compartment

- ▷ Open the luggage compartment floor and remove the tool storage box.

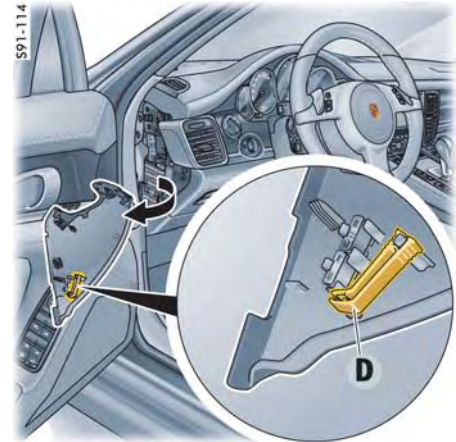

- D - Plastic gripper

Opening fuse box cover at the left and right of the dashboard

1. Carefully lever off the plastic cover with a screwdriver (**arrow**) and remove it. The positions of the fuses are shown on the inside of the cover.
 2. Carefully remove the fuses using the plastic gripper **D**.
- ▷ Spare fuses can be found in both fuse box covers (left: 7.5 and 10 A; right: 20 and 25 A).

Fuse box in left side of dashboard

No.	Designation	A
1	Steering column switch	7.5
2	Instrument cluster	7.5
3	PCM 3.1	10
4	Additional instrument	5
5	Air conditioning, front + rear	10
6	Rearview camera	5
7	LHD, electric parking brake button	5
8	LHD, central locking for rear left door RHD, central locking for left doors	10
9	LHD, steering column adjustment	15
10	LHD, PDK control unit	25
11	Power windows, rear left	25
12	Power windows, front left	25
13	ParkAssist	5
14	Xenon headlight, left	15
15	Interior mirror, LHD, diagnostic socket	5
16	LHD, PDK control unit, clutch sensor RHD, air conditioning, sun sensor	5
17	Not used	
18	Not used	
19	Not used	
20	LHD, ignition lock control unit, light switch	5

No.	Designation	A
21	LHD, central locking for front left door RHD, mobile phone charger	10 5
22	Steering column lock	5
23	Left-hand drive vehicles only: Turn signal, rear right Marker light, front left Low beam headlight, right High beam headlight, right Side turn signals, front Cornering light, front left Ignition lock Two-tone horns PSM Starter relay Emergency flasher switch LED Ignition lock lighting Turn signal, front left/right Footwell lights Ignition lock anti-removal lock Power steering control valves	30

FarmaSOS.com

No.	Designation	A
24	Left-hand drive vehicles only: Turn signal, rear left Marker light, front right Low beam headlight, left High beam headlight, left Cornering light, front right Engine compartment lid light Shutter elements, right/left Active brake ventilation open/closed Heatable washer jets Engine compartment lid Headlight beam adjustment	30
25	Left-hand drive vehicles only: Steering column lock Filler flap closed/open Windshield washer pump, front/rear	15
26	LHD, headlight cleaning system	30
27	Ignition coils	15
28	Not used	
29	Oil level sensor, camshaft sensor	7.5
30	Oxygen sensors behind catalytic converter	7.5
31	Electric control valves for engine	15
32	Engine control unit	20
33	Fan activation, tank leakage detection	10
34	Valves for engine	10
35	Oxygen sensors ahead of catalytic converter	10

No.	Designation	A
36	Not used	
37	Not used	
38	Front cigarette lighter, luggage compartment socket	20
39	Seat adjustment, front left without memory	30
40	RHD, center console sockets, glove box	20
41	PSM control unit	10
42	Interior light in roof console	7.5
43	Not used	
44	Not used	
45	Not used	
46	Not used	
47	Slide/tilt roof	30
48	Windshield wipers	30
49	Engine control unit	5
50	Not used	
51	Seat adjustment, front left with memory	30
52	Seat adjustment, rear left	20
53	Circulating pump	10
54	Rain sensor	5
55	Not used	
56	Not used	
57	Air-conditioning system fan	40

Fuse box in right side of dashboard

No.	Designation	A
1	Tire Pressure Monitoring control unit	5
2	Not used	
3	Seat heating, front	30
4	Seat heating, rear	30
5	Seat adjustment, rear right	20
6	Not used	
7	Not used	
8	Seat adjustment, front right with memory	30
9	RHD, electric parking brake button	5
10	LHD, handset, mobile phone charger	5
	RHD, steering column adjustment	15
11	RHD, PDK control unit	25
12	LHD, telephone	5
13	Not used	
14	Xenon headlight, right	15
15	Not used	
16	RHD, diagnostic socket	5
17	PSM control unit	5
18	LHD, air conditioning, sun sensor	5
	RHD, PDK control unit, clutch sensor	
19	Garage door opener	5
20	Air bag control unit	7.5
21	Advanced air bag, occupant sensing	5
22	Steering column switch	5

No.	Designation	A
23	Adaptive cruise control (ACC)	5
24	Seat ventilation, front seats	7.5
25	Seat ventilation, rear seats	7.5
26	Not used	
27	Front center console socket, Rear cigarette lighter	20
28	Seat adjustment, front right without memory	30
29	LHD, rear center console socket, socket in glove box, socket in large rear center console	20
30	Not used	
31	Coolbox	15
32	Rear Seat Entertainment	7.5
33	Right-hand drive vehicles only: Turn signal, rear right Marker light, front left Low beam headlight, right High beam headlight, right Side turn signals, front Cornering light, front left Ignition lock Two-tone horns PSM Starter relay Emergency flasher switch LED Ignition lock lighting Turn signal, front left/right Footwell lights Ignition lock anti-removal lock Power steering control valves	30

No.	Designation	A		
34	Right-hand drive vehicles only: Turn signal, rear left Marker light, front right Low beam headlight, left High beam headlight, left Cornering light, front right Engine compartment lid light Shutter elements, right/left Active brake ventilation open/closed Heatable washer jets Engine compartment lid Headlight beam adjustment	30		
	Right-hand drive vehicles only: Steering column lock Filler flap closed/open Windshield washer pump, front/rear		15	
	36 RHD, headlight cleaning system			30
	37 Not used			
	38 Not used			
	39 PSM control unit			25
	40 LHD, central locking for front/rear right door			10
	41 Power windows, front right			25
	42 Power windows, rear right			25
	43 Alarm horn			5
44 Vehicle Tracking System VTS	5			
45 Not used				
46 Not used				

No.	Designation	A
47	Fuel pump control unit	25
48	Horn (two-tone horns)	15
49	Diagnostic socket	5
50	RHD, ignition lock, light switch	5
51	RHD, central locking for front right door	10
52	RHD, steering column lock	5
53	Not used	
54	Not used	
55	Not used	
56	Not used	
57	PSM pump control unit	40

تلفن شبانه روزی: ۰۲۱-۸۸۶۲۰۸۵

FarmaSOS.com

Fuse and relay carriers in the luggage compartment

No.	Fuse carrier A	A
1	Not used	
2	Spoiler flap (Turbo)	10
3	Audio amplifier (Burmester®)	30
	Audio amplifier (ASK Sound, Bose)	25
4	Start/Stop control unit	30
5	Start/Stop control unit	30
6	Differential lock	10
7	Differential lock	30
8	Subwoofer (Bose, Burmester®)	30
9	Powerlift tailgate	25
10	PASM control unit	25
11	Luggage compartment lights	5
12	PDCC control unit	10

No.	Fuse carrier B	A
1	Daytime driving lights, right Tail light, right Reversing light, right Rear fog light, left Brake light, right Raised brake light Sun blind Electric steering column lock Rear wiper Heated rear window Interior surveillance/inclination sensor PASM Engine control unit Safety/curb lights, front doors Interior light/reading light, front Interior light, rear Orientation light Licence plate light Engine speed hall senders 1+3 Interior light	15
2	Daytime driving lights, left Tail light, left Reversing light, left Rear fog light, right Brake light, left Safety/curb lights, rear doors Exhaust flap control Filler flap closed Extend/retract spoiler	15

No.	Fuse carrier B	A
3	Tailgate closing mechanism Filler flap open Retract/extend rear spoiler Sun blind	30
4	Alarm horn	15
5	Gateway control unit	5
6	Heated rear window	20
7	PASM control unit	5
8	Gateway control unit	5
9	Electric parking brake	5
10	Differential lock	10
11	PDCC control unit	10
12	Rear wiper	15

No.	Relay carrier C
1	Heated rear window
2	Not used
3	Spoiler flap (Turbo)
4	Spoiler flap (Turbo)
5	PASM/LF compressor

LHD = Left-hand drive vehicles

RHD = Right-hand drive vehicles

Note

- ▷ Use the plastic gripper **D** when replacing the fuses. This can be found in the fuse box cover on the dashboard.
- ▷ Spare fuses can be found in both fuse box covers on the dashboard (left: 7.5 and 10 A; right: 20 and 25 A).

تلفن شبانه روزی: ۰۲۱-۸۸۸۶۲۰۸۵

FarmaSOS.com

Battery



Risk of short circuit and fire, resulting in serious personal injury or death.

- ▷ Observe all warning notes on the battery.
- ▷ Disconnect the negative terminal on the battery during all work on the electrical system.
- ▷ Do not lay tools or other metal objects on the battery as they could cause a short circuit across the battery terminal.

Hydrogen gas generated by the battery could cause an explosion, resulting in serious personal injury or death.

- ▷ Charge battery in a well ventilated area.
- ▷ Never charge a frozen battery. It may explode because of gas trapped in the ice. Allow a frozen battery to thaw out first.
- ▷ Do not expose the battery to an open flame, electrical spark or a lit cigarette.

Risk of explosion as a result of static charge, resulting in serious personal injury or death.

- ▷ Do not wipe the battery with a dry cloth.
- ▷ Before touching the battery, discharge any static electricity by touching the vehicle.

Risk of serious personal injury or death and damage to the fabric, metal or paint.

- ▷ Wear eye protection.
- ▷ Do not allow battery acid to come in contact with your skin, eyes, fabric or painted surfaces.
- ▷ If you get electrolyte, which is an acid, in your eyes or on your skin, immediately rinse with cold water for several minutes and call a doctor.
- ▷ Spilled electrolyte must be rinsed off at once with a solution of baking soda and water to neutralize the acid.

Battery posts, terminals and related accessories contain lead and lead compounds, chemicals known to the State of California to cause cancer and reproductive harm.

- ▷ Always protect your skin by washing thoroughly with soap and water.

The battery is located in the battery box under the left front seat.

Charge state

A well charged battery will not only prevent starting problems but will also last longer.

In order to avoid unintended battery discharge

- ▷ Switch off unnecessary electrical loads in city traffic, on short trips or in a line of traffic.
- ▷ Always remove the ignition key from the ignition switch when leaving the vehicle or switch ignition off in vehicles **with** Porsche Entry & Drive.
- ▷ Avoid using the Porsche Communication Management system and the audio system when the engine is not running.

Maintenance note

In the cold season, in particular, or if you mainly drive only short distances, it may become necessary to recharge the battery from time to time.

Battery care

- ▷ Ensure that battery is securely mounted.
- ▷ Keep terminals and connections clean and properly tightened. Corrosion can be prevented by coating the terminals and connections with petroleum jelly or silicone spray.
- ▷ Ensure that vent caps are securely tightened to prevent spillage.

Checking the electrolyte fluid level (only on low-maintenance batteries)

Generally, the electrolyte level must be checked more often in summer than in the winter, and more often when driving long distances.

- ▷ When adding water, use only clean containers. In no case may alcohol (e.g. window cleaner residues) be permitted to enter the battery.
- ▷ Unscrew and open the filler vent caps of each cell.

With the car on a level surface, the fluid level should meet the indicator mark in each cell.

- ▷ If necessary, top up with distilled water. Do not use acid. Only fill up to the mark, otherwise the electrolyte will overflow when the battery is being charged and cause damage.

Winter operation

During the winter months, battery capacity tends to decrease as temperatures drop. Additionally, more power is consumed while starting, and the headlights, heater, rear window defogger, etc., are used more frequently.

- ▷ Let your Porsche dealer test the battery's capacity before winter sets in.

Vehicle storage

If the car stands for long periods in the garage or workshop, the doors and lids should be closed.

- ▷ Remove the ignition key and, if necessary, disconnect the battery.

Notes on operation

- ▷ When the battery is disconnected, the alarm system ceases to function. If the vehicle was locked before the battery was disconnected, the alarm will be triggered when the battery is reconnected. To deactivate the alarm system:
 - ▷ Lock the vehicle and unlock it again.

Alarm system, central locking

- ▷ The status of the central locking and alarm system is not changed by disconnecting the battery.

Maintenance notes

Even if you put your vehicle out of operation, the battery still discharges.

The battery will discharge more quickly if your vehicle is not driven on a daily basis over a distance of several miles. The more often you drive your vehicle, and the longer the distance driven on each trip, the more opportunity the vehicle's charging system will have to recharge the batteries.

- ▷ To preserve its efficiency, charge the battery about every 6 weeks.
- ▷ Check the battery acid level and top off with distilled water if necessary.
- ▷ Store a battery that has been removed in a dark, cool place, but not subject to freezing.

Replacing the battery

The service life of the battery is subject to normal wear; it depends greatly on care, climatic conditions, and driving conditions (distances, loads).

- ▷ Only use an original Porsche battery, with the correct part number, as a replacement. Only this battery meets the specific requirements of the vehicle.
- ▷ Please observe the disposal instructions for batteries.

Putting vehicle into operation

After the battery is connected or after a **fully discharged** battery is charged, the PSM warning light lights up on the instrument panel and a message appears on the multi-function display in the instrument panel to indicate a fault.

This fault can be corrected with a few simple steps:

1. Start the engine.
To do this, turn the ignition key or the control unit (on vehicles with Porsche Entry & Drive) to ignition lock position **2, twice**.
2. With the vehicle stationary, perform a few steering movements to the left and right and then drive a short distance in a straight line until the PSM warning light goes out and the message is erased from the multi-function display in the instrument panel.
3. If the warnings do **not** disappear, then: Drive carefully to the nearest authorized Porsche dealer to have the fault corrected.
4. After the warnings go out: Stop the vehicle in a suitable place.
5. Store the end position for the power windows.

For information on storing the end positions for the power windows:

- ▷ Please see the chapter “STORING END POSITION OF THE DOOR WINDOWS AFTER CONNECTING THE VEHICLE BATTERY” on page 88.
- 6. Teach tires on vehicles with Tire Pressure Monitoring.

For information on teaching the Tire Pressure Monitoring system:

- ▷ Please see the chapter “TIRE PRESSURE MONITORING (TPM)” on page 127.
- 7. Store end position on vehicles with a slide/tilt roof.

For information on storing the end position for the slide/tilt roof:

- ▷ Please see the chapter “STORING END POSITION OF THE SLIDE/TILT ROOF” on page 90.

External Power Supply, Jump-Lead Starting

If the battery is flat, the battery of another vehicle can be used for starting or as an external power supply with the help of jump leads.

Both batteries must be 12 V batteries.

The capacity (Ah) of the donor battery must not be substantially less than that of the flat battery.

The flat battery must be connected correctly to the vehicle's electrical system.

Warning!

Risk of short circuit, damage and explosion, resulting in serious personal injury or death.

- ▷ Use only jumper cables of adequate diameter cross-section and fitted with completely insulated alligator clips.
- ▷ Follow all warnings and instructions of the jumper cable manufacturer.
- ▷ When connecting jumper cables, make sure that they cannot get caught in any moving parts in the engine compartment. The jumper cables must be long enough so that neither vehicles nor cables touch another.
- ▷ The vehicles must not be in contact, otherwise current might flow as soon as the positive terminals are connected.
- ▷ The cable clamps must not be allowed to contact each other when one end of the jumper cables are connected to a battery.

- ▷ Carefully ensure that tools or conductive jewellery (rings, chains, watch straps) do not come into contact with the positive jumper cable or the positive battery post.
- ▷ Improper hook-up of jumper cables can ruin the alternator.

Danger of caustic burns.

- ▷ Do not lean over the battery.

Danger of gas explosion.

- ▷ Improper use of booster battery to start a vehicle may cause an explosion, resulting in serious personal injury or death.
- ▷ Keep sources of ignition away from the battery, e.g. open flame, burning cigarettes or sparking due to cable contact or welding work.
- ▷ A discharged battery can freeze even at 14 °F (-10 °C). Before connecting jumper cables, a frozen battery must be thawed out.

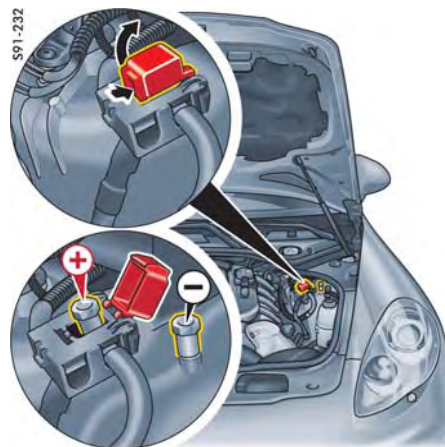

+ = Positive terminal for jump-lead starting

- = Ground point for jump-lead starting

External power supply/jump-lead starting

Always observe the sequence below:

1. Open the cap on the positive terminal for jump-lead starting (+).
2. Attach the positive lead first to the positive terminal for jump-lead starting (+), then to the positive terminal of the donor battery.
3. Connect the negative lead first to the negative terminal of the donor battery, then to the ground point for jump-lead starting (-).

4. Leave the engine of the donor vehicle running at a higher engine speed.
5. Start the engine.
An attempted start using jump leads should not last more than 15 seconds. Then wait for at least one minute.
6. Disconnect the negative lead from the ground point for jump-lead starting (-) first, then from the negative terminal of the donor battery.
7. Disconnect the positive lead from the positive terminal of the donor battery first, then from the positive terminal for jump-lead starting (+).
8. Close the cap on the positive terminal for jump-lead starting (+).

Charging the battery

Automotive batteries lose their efficiency when not in use. The charge available in your battery can be measured with a battery hydrometer. We recommend that the battery voltage be tested by your Porsche dealer who has the appropriate equipment.

If the car is not driven for prolonged periods, the battery must be charged at least every 6 weeks. A discharged battery allows rapid formation of sulfates, leading to premature deterioration of the plates.

Danger!

Hydrogen gas generated by the battery could cause an explosion, resulting in serious personal injury or death.

- ▷ Charge battery in a well ventilated area.
- ▷ Never charge a frozen battery. It may explode because of gas trapped in the ice. Allow a frozen battery to thaw out first.
- ▷ If you get electrolyte, which is an acid, in your eyes or on your skin, immediately rinse with cold water for several minutes and call a doctor.

Your authorized Porsche dealer will be pleased to advise you about a suitable charger.

- ▷ Always observe the instructions provided by the charger manufacturer.
1. Connect the charger to the jump-lead starting terminals.
Only plug into the mains and switch the charger on when it is connected up correctly.
 2. Switch on the charger.
 3. After charging the battery, first switch off the charger and then disconnect it.
- ▷ Please see the chapter "PUTTING VEHICLE INTO OPERATION" on page 305.

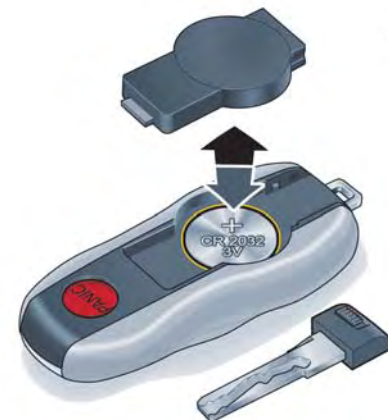

Changing the Remote Control Battery

Note

- ▷ Please observe the regulations for disposing of batteries.

Car key

If the battery in the remote control becomes too weak, the message "Replace ignition key battery" will appear on the multi-function display in the instrument panel.
The battery should be changed in this case.

Changing the battery (CR 2032, 3V)

1. Remove the emergency key.
2. Lever off the cover on the back of the key housing using a small screwdriver.
3. Change the battery (check polarity).
4. Re-fit cover and press together firmly.
5. Insert the emergency key.

Replacing Bulbs



Risk of serious personal injury or death. The headlights are under high voltage when installed.

- ▷ Exercise extreme care when working close to the headlights.

Risk of short circuit.

- ▷ Always switch off the relevant load when changing bulbs.

Risk of damage. Bulbs of a high wattage can damage the housing.

- ▷ Only use the bulbs specified in the bulb chart.
- ▷ Bulbs must be clean and free from grease.
- ▷ Never touch bulbs with your bare hands. Use a cloth or soft paper when replacing bulbs.
- ▷ Always carry spare bulbs with you. In certain countries, it is mandatory to carry spare bulbs.

Headlights



Risk of damage to headlights due to abrasion and excessive temperatures.

- ▷ Do not affix any coverings (e.g. "stone guards" or films) on or around the headlights.
- ▷ Use soapy water only to clean light lenses and plastic headlight lenses. In no case may chemical cleaners or other volatile cleaning fluids be used.
- ▷ To prevent scratches, do not rub with a dry or merely moist cloth, tissue or insect sponges.

Note

The headlights can mist up due to temperature and humidity.

- ▷ To ensure optimum ventilation, do not cover the gap between headlight and body.

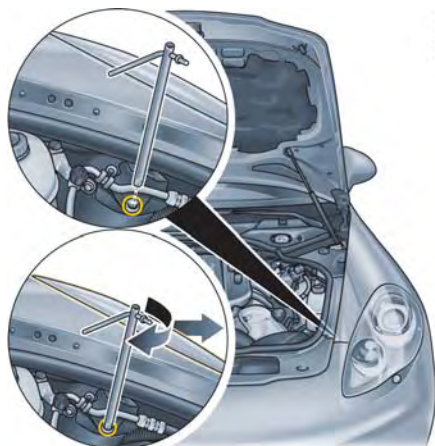

S91-226

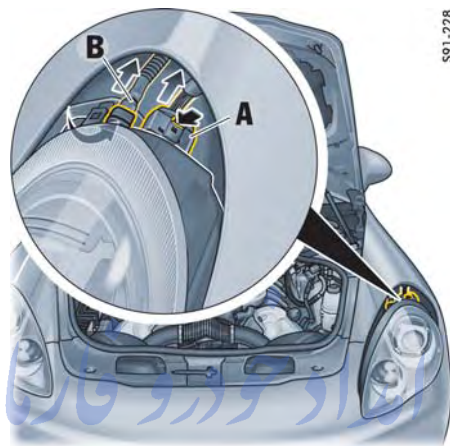

S91-228

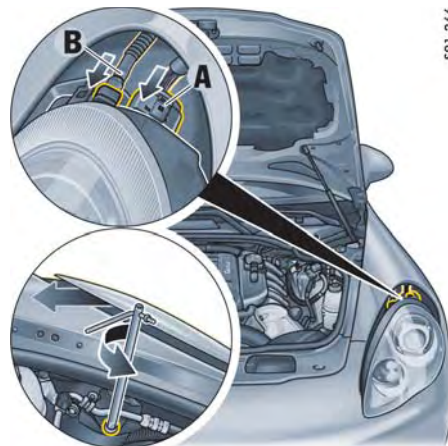

S91-264

Removing headlights

1. Switch off the ignition and remove the ignition key, or pull out the control unit on vehicles with Porsche Entry & Drive.
2. Open the engine compartment lid.
3. Take a socket wrench out of the tool kit.
4. Place the socket wrench on the release and turn in direction of arrow until you feel and hear the headlight being released.

5. Pull headlight approx. 4 in. (10 cm) forward out of the fender.
6. Press back the release tab of the connector **A** and pull connector off.
7. Press the release lever on the underside of the rapid-action coupling on the breather hose **B** up and pull it off.
8. Pull headlight out completely.

Installing headlights

1. Move the headlight release mechanism to unlock position. Insert the headlight into the guide rails, attach the connector **A** and breather hose **B** and then slide the headlight fully into the fender.
2. Press the headlight to the rear and simultaneously turn the socket wrench in direction of arrow. You should feel and hear the headlight locking mechanism engage.
3. Check that the headlight is seated securely.
4. Remove the socket wrench and place it in the tool kit.
5. Close engine compartment lid.



S91-216

Changing bulbs for static cornering light/ auxiliary high-beam headlight

Changing bulb (H7, 55W) for static cornering light

1. Remove the headlight.
- ▷ Please see the chapter "REMOVING HEADLIGHTS" on page 309.
2. Press the release tab and open the cover.

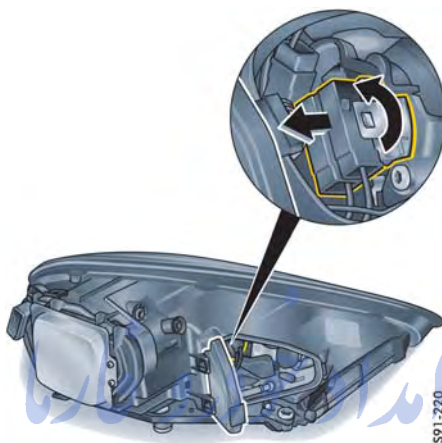

S91-220

3. Turn the bulb socket counter-clockwise and remove it.

تلفن شبانه روزی: ۰۲۱-۸۸۸۶۲۰۸۵

FarmaSOS.com

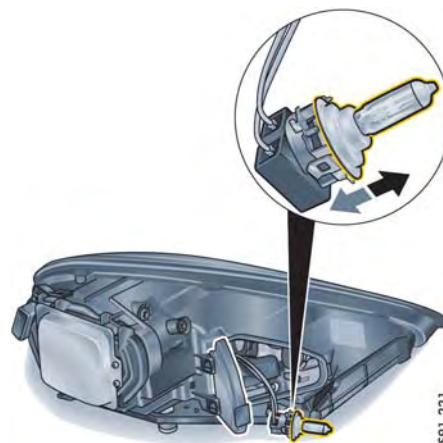

S91-221

4. Remove defective bulb and replace it. Make sure that the bulb is installed in the correct position.
5. Close cover on headlight. The release tab must engage fully.
6. Install the headlight.
- ▷ Please see the chapter "INSTALLING HEADLIGHTS" on page 309.
7. Check operation of bulbs.

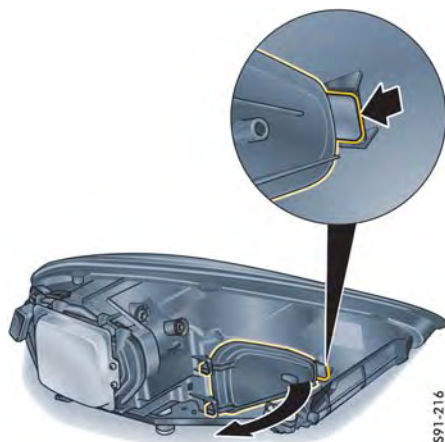

S91-216

Changing bulb (H7, 55W) for auxiliary high-beam headlight

1. Remove the headlight.
 - ▷ Please see the chapter "REMOVING HEADLIGHTS" on page 309.
2. Press in the release tab and open the cover.

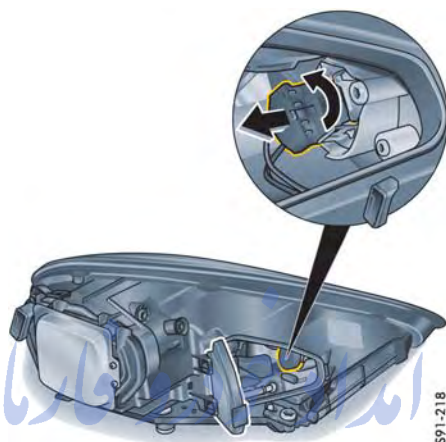

S91-218

3. Turn the bulb socket counter-clockwise and remove it.

تلفن شبانه روزی: ۰۲۱-۸۸۸۶۲۰۸۵

FarmaSOS.com

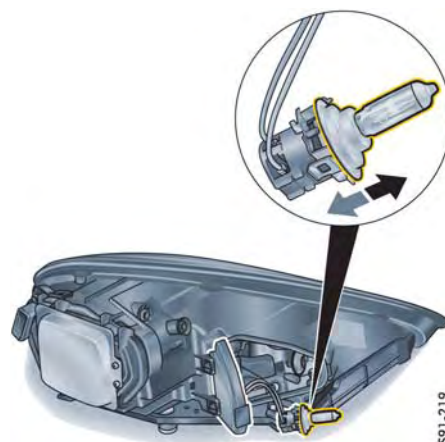

S91-219

4. Remove defective bulb and replace it. Make sure that the bulb is installed in the correct position.
5. Close cover on headlight. The release tab must engage fully.
6. Install the headlight.
 - ▷ Please see the chapter "INSTALLING HEADLIGHTS" on page 309.
7. Check operation of bulbs.

S91-238

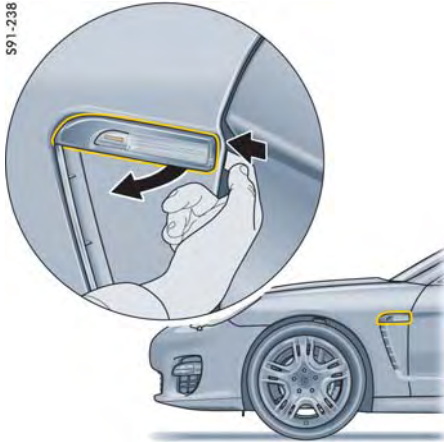

Side Turn Signal Light

Changing bulb (WY5W)

- ▷ Open the door.



Caution!

Danger of crushing if the door is closed while removing the turn signal light.

- ▷ Do not close the door while removing the turn signal light.

S91-240

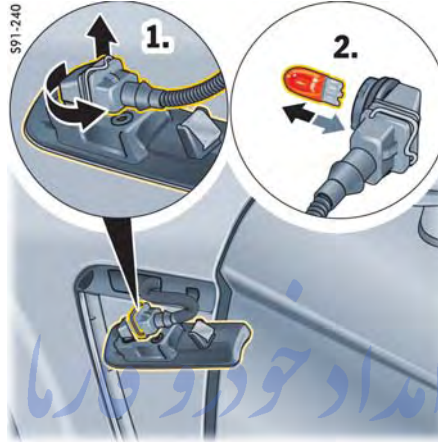

- ▷ Press the securing spring on the turn signal light in through the opening in the fender with your finger and remove the turn signal light.
1. Turn the bulb socket counter-clockwise and remove it.
 2. Remove defective bulb and replace it.
- ▷ Insert the bulb holder and turn it clockwise as far as it will go.

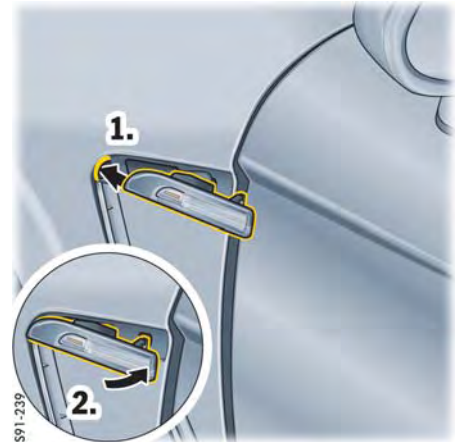

S91-239

1. Insert front turn signal light.
 2. Press in securing spring until it engages securely.
- ▷ Check operation of bulb.

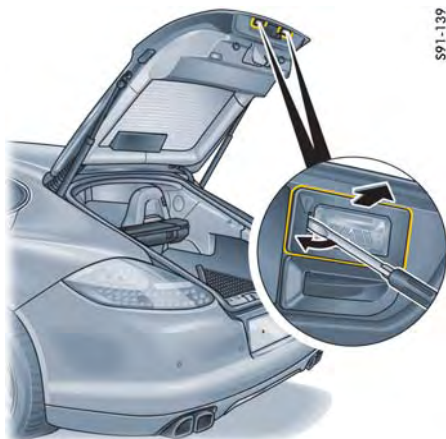

S91-139

Licence Plate Lights

Changing bulb (C5W)

1. Open the tailgate.
2. Position the blade of a screwdriver at the left on the light cover and lever off the light cover.
3. Remove bulb and replace it.
4. Clip in the light cover.
5. Close the tailgate and check operation of bulb.

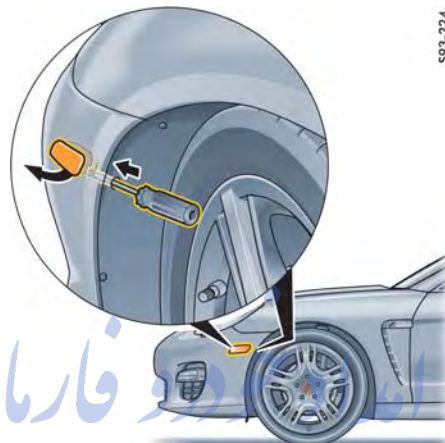

S93-224

Side Marker Light

Changing bulb (W5W)

1. Remove the cap in the wheel housing liner with a screwdriver.
2. Insert the screwdriver into the opening in the wheel housing liner parallel to the side marker light housing (in direction of travel). By pressing with the screwdriver, disengage the securing spring of the side marker light housing.

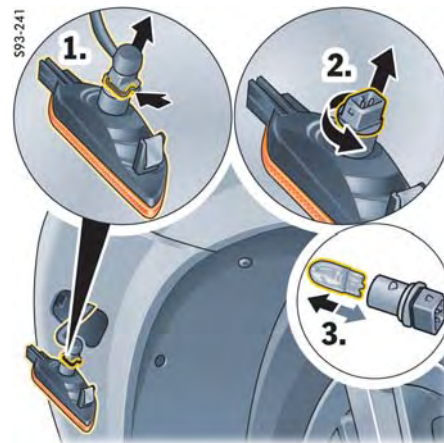

S93-241

1. Press the cable retaining clip and detach the cable from the bulb holder.
2. Turn the bulb socket counter-clockwise and remove it.
3. Remove defective bulb and replace it.
4. Insert the bulb holder and turn it clockwise as far as it will go.
5. Push the cable onto the bulb holder until it audibly engages.

S93-225

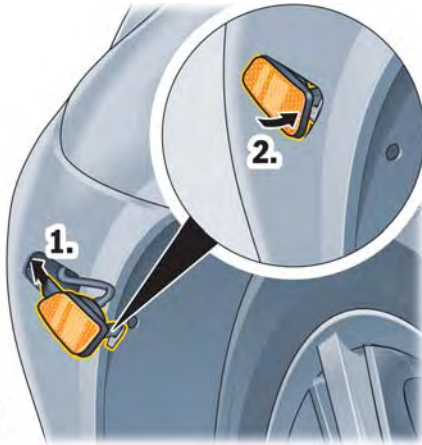

1. Insert front side marker light.
 2. Press in securing spring until it engages securely.
- ▷ Check operation of bulb.

Changing Light-Emitting Diodes and Long-Life Bulbs

Daytime driving lights, front side lights, front turn signal lights, gas-discharge bulbs in Bi-Xenon headlights, as well as additional brake lights and interior lights have light-emitting diodes and long-life bulbs.

The LEDs cannot be replaced individually. Replacement of the long-life bulbs involves a greater amount of installation work.

- ▷ Have defective LEDs and bulbs replaced in a qualified specialist workshop. Please contact a qualified specialist workshop. We recommend that you have an authorized Porsche dealer to do this work as they have trained workshop personnel and the necessary parts and tools.

تلفن شبانه روزی: ۰۲۱-۸۸۸۶۲۰۸۵

FarmaSOS.com

S93-332



Headlight Adjustment

- ▷ Check tire pressure and adjust if necessary.
- ▷ Please see the chapter "TIRE PRESSURE FOR COLD TIRES (68 °F/20 °C)" on page 326.
- ▷ Please see the chapter "REPLACING BULBS" on page 308.

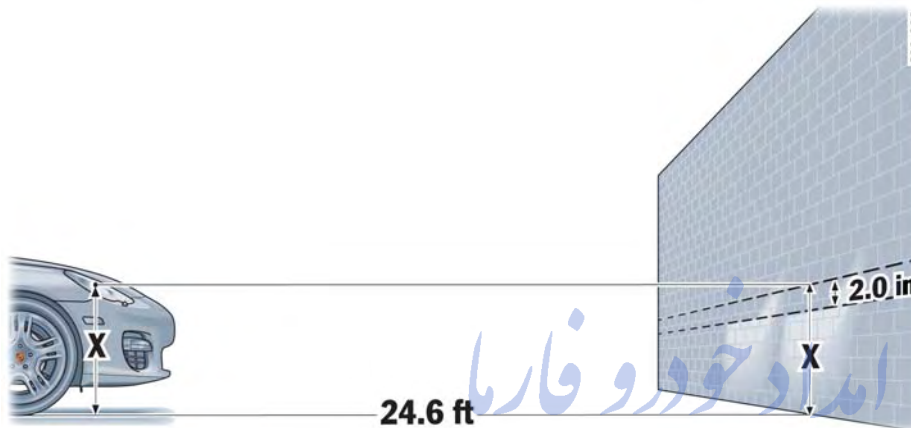

Screen

The screen upon which headlamp beams are projected is perpendicular to the floor and the vehicle's longitudinal axis, flat, uniformly light in color, unobstructed, and wide and high enough to accommodate the vehicle beam patterns to be aimed.

The screen should be wide enough to provide at least 3.3 ft. (1 m) of space outboard of the vehicle's headlamp spacing.

Adjustment

The adjustment is made with the vehicle ready to drive and the fuel tank completely filled.

The driver's seat must be loaded by a person or a 165 lbs. (75 kg) weight and the tire pressures must meet the prescribed values. After being loaded, the car must be rolled a few meters so that the suspension can settle.

For checking the headlight adjustment, the vertical position of the cutoff of the lowbeam (see fig.) has to be projected on a vertical screen (wall) in distance of 24.6 ft. (7.5 m) from the front lens of the headlamp. The correct position of the cutoff is 3.0 in. (7.5 cm) at 24.6 ft. or 7.5 m (0.4°) below a horizontal line, x cm from ground to the center of the headlamp lens.

Lateral adjustment of the headlights should be carried out at a specialist workshop with an optical adjustment unit.

Distance

Visual aim shall be performed at not less than 24.6 ft. (7.5 m) (this value is a rounded down conversion from the 25-foot distance typical of field aim using a screen). The 24.6 ft. (7.5 m) distance is measured from the headlamp lens to the viewing screen.

Floor

The surface upon which the vehicle rests is flat and approximately level.



Height adjustment

1. Switch ignition on.
2. Switch on low beam.
3. Open engine compartment lid.
4. Place allen key (6 mm) on adjusting screw.
5. Adjust low beam in direction of the arrow.

591-227

Towing

Certain state statutes and local ordinances prohibit towing with a chain, rope or even a tow bar. In addition, damage to your vehicle may result from improper procedures. Consult your authorized Porsche dealer for details.

Flat bed towing is the preferred type of towing to be used on Porsche vehicles.

Tips on driving

- ▷ Always observe the laws governing towing and tow-starting.
- ▷ Exercise extreme care when your vehicle is being towed.
- If a turn signal is operated when the ignition and emergency flasher is switched on, only the turn signal on the corresponding side of the vehicle lights up. The emergency flasher is switched back on again when the turn signal is switched off.

FarmaSOS.com

Warning!

Risk of accidents. No power assistance is available on the towed vehicle when its engine is not running. Greater force is therefore required when braking and steering.

- ▷ Exercise extreme care when your vehicle is being towed.

When the engine is not running, adequate lubrication of the transmission is not guaranteed. Observe the following points to avoid damage to the transmission.

Panamera S

Towing a vehicle with PDK transmission on all four wheels

Caution!

We urge that wherever possible, a car transporter or trailer be used to transport a Panamera vehicle that cannot move under its own power. This is the safest way to transport a down vehicle.

For those instances where a car transporter or trailer is not available, the vehicle may be towed on all four axles only, provided the following conditions are strictly met. Failure to meet these conditions will result in serious and expensive damage to the PDK transmission.

If the vehicle's transmission or shifter is already damaged, serious damage will result if the vehicle is not towed with all four wheels off the ground.

Porsche cannot be held responsible for damage incurred in cases where a vehicle has been transported on one or both of its axles.

- ▷ The vehicle must not be towed if the PDK transmission is in emergency operation mode (yellow or red "Gearbox emergency operation" warning message). The vehicle must be transported with a car transporter or on a trailer.
- ▷ If a selector lever emergency release was performed, the vehicle must not be towed. The vehicle must be transported with a car transporter or on a trailer.
- ▷ Move PDK selector lever to position **N**. To properly engage selector-lever position **N** on the display and at the selector lever, the engine must be started once before towing the vehicle. The vehicle can be towed as soon as the selector lever is in position **N** and selector-lever position **N** appears on the display.
- ▷ The vehicle must always roll on all four wheels when towed. The ignition must be switched on so that the brake lights and turn signal lights operate and the steering lock cannot engage.
- ▷ Do not exceed a maximum speed of 30 mph (50 km/h).

Maximum towing distance 30 miles (50 km). If towing distances are greater, the vehicle must be transported with a car transporter or on a trailer.

Panamera S

Towing a vehicle with PDK transmission on one axle

- ▷ The vehicle must not be towed if the PDK transmission is in emergency operation mode (yellow or red "Gearbox emergency operation" warning message). The vehicle must be transported with a car transporter or on a trailer.
- ▷ If a selector lever emergency release was performed, the vehicle must not be towed. The vehicle must be transported with a car transporter or on a trailer.
- ▷ Move PDK selector lever to position **N**. To properly engage selector-lever position **N** on the display and at the selector lever, the engine must be started once before towing the vehicle. The vehicle can be towed as soon as the selector lever is in position **N** and selector-lever position **N** appears on the display.
- ▷ Switch ignition off. The ignition key must remain in the ignition lock so that the steering wheel lock does not engage. The control unit must be removed from the

ignition lock and the key inserted in vehicles with Porsche Entry & Drive.

- ▷ Please see the chapter "REMOVING THE CONTROL UNIT FROM THE IGNITION LOCK" on page 165.
- ▷ Make sure that the vehicle is adequately illuminated.
- ▷ Do not exceed a maximum speed of 30 mph (50 km/h). Maximum towing distance 30 miles (50 km). If towing distances are greater, the vehicle must be transported with a car transporter or on a trailer.

Panamera 4S, Panamera Turbo

Towing a vehicle with PDK and all-wheel drive

Caution!

We urge that wherever possible, a car transporter or trailer be used to transport a Panamera vehicle that cannot move under its own power. This is the safest way to transport a down vehicle.

For those instances where a car transporter or trailer is not available, the vehicle may be towed on all four axles only, provided the following conditions are strictly met. Failure to meet these conditions will result in serious and expensive damage to the PDK transmission.

If the vehicle's transmission or shifter is already damaged, serious damage will result if the vehicle is not towed with all four wheels off the ground.

Porsche cannot be held responsible for damage incurred in cases where a vehicle has been transported on one or both of its axles.

- ▷ The vehicle must not be towed if the PDK transmission is in emergency operation mode (yellow or red "Gearbox emergency operation" warning message). The vehicle must be transported with a car transporter or on a trailer.
- ▷ If a selector lever emergency release was performed, the vehicle must not be towed. The vehicle must be transported with a car transporter or on a trailer.
- ▷ The vehicle must have all four wheels on the ground when being towed or it must be transported on a car transporter. The vehicle must not be raised at one axle, irrespective of whether it is the front or rear axle.
- ▷ Move PDK selector lever to position **N**. To properly engage selector-lever position **N** on the display and at the selector lever, the engine must be started once before towing the vehicle. The vehicle can be towed as soon as the selector lever is in position **N** and selector-lever position **N** appears on the display.

- ▷ Switch off the ignition or leave the engine running. The ignition key must remain in the ignition lock so that the steering wheel lock does not engage. The control unit must be removed from the ignition lock and the key inserted in vehicles with Porsche Entry & Drive.
- ▷ Please see the chapter "REMOVING THE CONTROL UNIT FROM THE IGNITION LOCK" on page 165.
- ▷ Make sure that the vehicle is adequately illuminated.
- ▷ Do not exceed a maximum speed of 30 mph (50 km/h). Maximum towing distance 30 miles (50 km). If towing distances are greater, the vehicle must be transported with a car transporter or on a trailer.

تلفن شبانه روزی: ۰۲۱-۸۸۸۶۲۰۸۵

FarmaSOS.com

Pulling out a vehicle stuck in snow, sand, etc.

- ▷ Always pull out the stuck vehicle with the greatest care.
- ▷ Do not pull out the vehicle abruptly or at an angle.
- ▷ If possible, pull the vehicle out backwards in its own tracks.

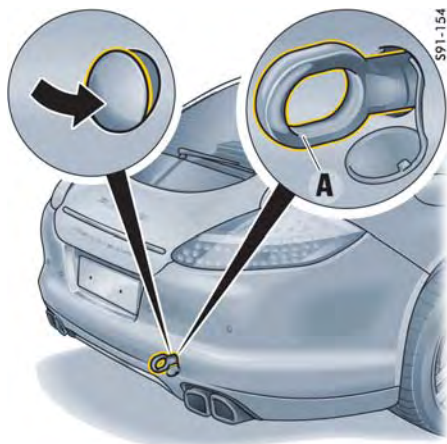

S91-154

- ▷ Never use the towing lug to tow this or any other vehicle.
- ▷ Bear in mind the limited ground clearance of your car on uneven surfaces.

Fitting the towing lug

1. Press the lower edge of the appropriate plastic cover into the bumper until the cover disengages.
2. Pull cover out of the bumper and let it hang by its thread.
3. Screw in towing lug **A** as far as it will go (left-hand thread) and tighten hand-tight.

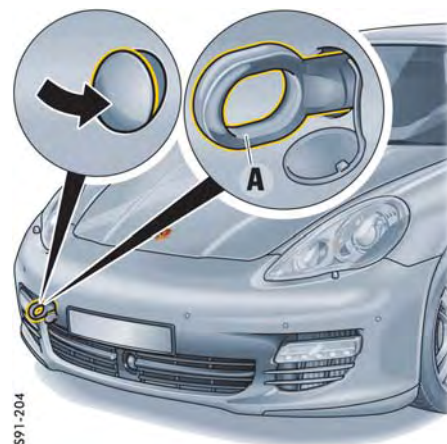

S91-204

Removing the towing lug

1. Unscrew the towing lug **A**.
2. Insert plastic cover at the lower edge of the opening.
3. Fold the cover up and press on its upper edge to engage it in the bumper.

Towing lug

The towing lug is stored in the tool storage box under the luggage compartment floor.



Caution!

Risk of damage to the vehicle.

- ▷ Use the towing lug only for an emergency to remove the vehicle off the road. The towing lug is to be used only to pull the vehicle onto the flat bed, tractor or towing apparatus if the vehicle will roll freely. Under no circumstances is the vehicle to be secured using the towing lug.

تلفن شبانه روزی: ۰۲۱-۸۸۸۶۲۰۸۵

FarmaSOS.com



Pulling vehicle onto flat bed

1. Position wooden ramps at the base of the flat bed to reduce the angle of the pull.
2. Reel in the hoist cable and check the underside of the vehicle for any interference.

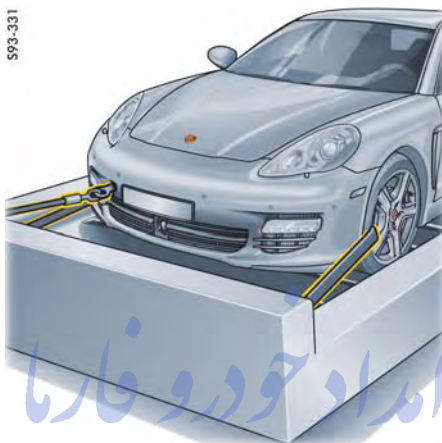

Tying down vehicle on flat bed

1. Carefully feed towing straps through the opening in the **rear wheels**.
Make sure metal parts of straps do not damage rim.
Make sure the strap is flat over the rim bead.
Make sure brake backing plate is not damaged.
2. Secure straps to rear of flat bed.
3. Reel in hoist cable only far enough to tension tie-down straps.

4. Carefully feed towing straps through the opening in the **front wheels**.
Make sure metal parts of straps do not damage rim.
Make sure the strap is flat over the rim bead.
Make sure brake backing plate is not damaged.
5. Secure straps to front of flat bed.
6. Release tension on hoist cable, but do not disconnect.
Use hoist cable as safety cable.

Transporting the vehicle on car trains, ferries and car transporters

- ▷ Tie the vehicle down only at its wheels.
- ▷ Deactivate interior surveillance and the inclination sensor.
- ▷ Please see the chapter "ALARM SYSTEM AND PASSENGER COMPARTMENT MONITORING" on page 247.

Tow-starting/push-starting



Caution!

Do not attempt to push-start or tow-start the vehicle under any circumstances. Vehicles equipped with PDK cannot be started by these means.

Serious transmission damage will result if the attempt is made to push-start or tow-start Panamera vehicles equipped with the PDK transmission.

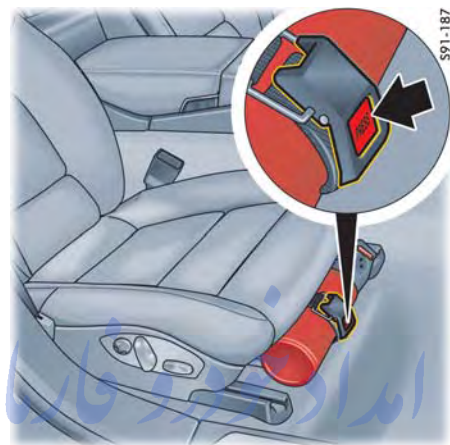

Fire Extinguisher

In cars with a fire extinguisher, the extinguisher is located under the passenger seat.

- ▷ To remove the fire extinguisher in case of an emergency, hold the extinguisher with one hand and press the button **PRESS** on the fire extinguisher holder with the other hand (**arrow**).

Notes

- ▷ Check the final inspection date on the fire extinguisher. If the fire extinguisher is used after its inspection interval has elapsed, it may not work properly.
- ▷ Always read the operating instructions on the fire extinguisher.
- ▷ The fire extinguisher should be checked to ensure correct operation by a specialist workshop every 1-2 years.
- ▷ Have the fire extinguisher refilled after use.

Tire Pressure and Technical Data

Vehicle Identification Data.....	323
Engine Data.....	324
Wheels, Tires.....	325
Tire Pressure for Cold Tires (68 °F/20 °C)....	326
Weights.....	328
Filling Capacities.....	329
Driving Performance	329
Dimensions	330

امداد خودرو فارما

تلفن شبانه روزی: ۰۲۱-۸۸۸۶۲۰۸۵

FarmaSOS.com



Vehicle identification number

Vehicle Identification Data

When ordering spare parts or making inquiries, always quote the vehicle identification number.

Vehicle identification number

You will find the vehicle identification number at the bottom left behind the windshield and under the front passenger's seat.

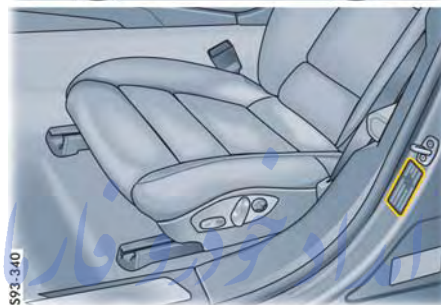

Safety compliance sticker

Safety compliance sticker

The safety compliance sticker is your assurance that your new Porsche complies with all applicable Federal Motor Vehicle Safety Standards which were in effect at the time the vehicle was manufactured.

The sticker also shows the month and year of production and the vehicle identification number of your car (perforations) as well as the **Gross Vehicle Weight Rating** and the **Gross Axle Weight Rating**.



Tire pressure plate

Tire pressure plate

The plate is attached to the door sill area on the driver's side.

Vehicle data bank

You will find the vehicle data bank in the "Maintenance" booklet. It contains all important data about your vehicle.

Note

The data bank cannot be re-ordered if it is lost or damaged.

Engine Data

	Panamera S	Panamera 4S	Panamera Turbo
Engine type	M 4820	M 4840	M 4870
Number of cylinders	8	8	8
Displacement	293.3 cu. in. (4806 cm ³)	293.3 cu. in. (4806 cm ³)	293.3 cu. in. (4806 cm ³)
Max. engine output as per 80/1269/EEC	400 hp (294 kW)	400 hp (294 kW)	500 hp (368 kW)
At engine speed	6500 rpm	6500 rpm	6000 rpm
Max. torque as per 80/1269/EEC	370 ftlb. (500 Nm)	370 ftlb. (500 Nm)	518 ftlb. (700 Nm) (overboost 570 ftlb. (770 Nm))
At engine speed	3500–5000 rpm	3500–5000 rpm	2250–4500 rpm (overboost 2500–4000 rpm)
Engine oil consumption	up to 1.6 quarts/621 miles up to 1.5 l/1000 km	up to 1.6 quarts/621 miles up to 1.5 l/1000 km	up to 1.6 quarts/621 miles up to 1.5 l/1000 km
Maximum permitted engine speed	6700 rpm	6700 rpm	6700 rpm

FarmaSOS.com

Wheels, Tires

- ▷ Approval of tire and wheel sizes is granted based on extensive testing. Your authorized Porsche dealer will be pleased to advise you about the current approval status.

By fitting tires that have been approved by Porsche, you can be sure that you have the best possible tires for your Porsche.

The load capacity coefficient (e.g. “105”) and code letter (e.g. “V”) for permitted top speed are minimum requirements.

When fitting new tires or changing tires: Please see the chapter “TIRES AND WHEELS” on page 280.

- ▷ Snow chain clearance can only be guaranteed for the tires marked ¹⁾. Snow chains can only be fitted on the rear wheels. Maximum speed 30 mph (50 km/h). Only use fine-link cross-type or edge chains approved by Porsche.

	Panamera S, Panamera 4S	Panamera Turbo
18-inch wheel front axle/rear axle	8J x 18, Rim offset 59 mm/9J x 18, Rim offset 53 mm	
Summer tires front axle/rear axle	245/50 ZR 18 (100Y)/275/45 ZR 18 (103Y)	
Snow tires front axle/rear axle	245/50 R 18 100V/275/45 R 18 103V ¹⁾	
19-inch wheel front axle/rear axle	9J x 19, Rim offset 60 mm/ 10J x 19, Rim offset 61 mm	9J x 19, Rim offset 60 mm/ 10J x 19, Rim offset 61 mm
Summer tires front axle/rear axle	255/45 ZR 19 (100Y)/285/40 ZR 19 (103Y)	255/45 ZR 19 (100Y)/285/40 ZR 19 (103Y)
Snow tires front axle/rear axle	255/45 R 19 100V/285/40 R 19 103V ¹⁾	255/45 R 19 100V/285/40 R 19 103V ¹⁾
20-inch wheel front axle/rear axle	9.5J x 20, Rim offset 65 mm/ 11J x 20, Rim offset 68 mm	9.5J x 20, Rim offset 65 mm/ 11J x 20, Rim offset 68 mm
Summer tires front axle/rear axle	255/40 ZR 20 (101Y) XL/295/35 ZR 20 (105Y) XL	255/40 ZR 20 (101Y) XL/295/35 ZR 20 (105Y) XL
20-inch wheel front axle/rear axle	9.5J x 20, Rim offset 65 mm/ 10.5J x 20, Rim offset 65 mm	9.5J x 20, Rim offset 65 mm/ 10.5J x 20, Rim offset 65 mm
Snow tires front axle/rear axle	255/40 R 20 101V XL/285/35 R 20 104V XL ¹⁾	255/40 R 20 101V XL/285/35 R 20 104V XL ¹⁾

Danger!

Installation of sizes not authorized by Porsche may have a dangerous effect on the driving stability and could result in serious personal injury or death.

- ▷ Before mounting new tires check with your Porsche dealer about the current release status.

Tire Pressure for Cold Tires (68 °F/20 °C)

These standard and comfort tire pressures apply only to the tire makes and types approved by Porsche.

Standard tire pressure for summer, winter and all-season tires

	Panamera S, Panamera 4S				Panamera Turbo			
	Part load		Full load		Part load		Full load	
	FA	RA	FA	RA	FA	RA	FA	RA
18-inch wheels	37 psi (2.5 bar)	37 psi (2.5 bar)	37 psi (2.5 bar)	43 psi (2.9 bar)				
19-inch wheels	37 psi (2.5 bar)	37 psi (2.5 bar)	37 psi (2.5 bar)	43 psi (2.9 bar)	40 psi (2.7 bar)	37 psi (2.5 bar)	40 psi (2.7 bar)	40 psi (2.7 bar)
20-inch wheels	40 psi (2.7 bar)	37 psi (2.5 bar)	41 psi (2.8 bar)	44 psi (3.0 bar)	43 psi (2.9 bar)	37 psi (2.5 bar)	44 psi (3.0 bar)	44 psi (3.0 bar)

- ▷ The load condition of the vehicle must be set on the multi-function display. The tire pressure must be changed according to the vehicle load. Please see the chapter "SELECTING "CHARGE" IN THE TIRE PRESSURE MENU" on page 130.

FA = front axle, RA = rear axle

Comfort tire pressure for summer, snow and all-season tires up to 100 mph (160 km/h)

The **comfort tire pressure speed threshold permitted** for your vehicle depends on the national type standardisation and is displayed under “**Comfort pressure**” in the “**Tire pressure**” menu on the multi-function display on the on-board computer.

		Panamera S, Panamera 4S				Panamera Turbo			
		Part load		Full load		Part load		Full load	
		FA	RA	FA	RA	FA	RA	FA	RA
Summer tires	18-inch wheels	30 psi (2.0 bar)	30 psi (2.0 bar)	30 psi (2.0 bar)	30 psi (2.0 bar)				
	19-inch wheels	30 psi (2.0 bar)	30 psi (2.0 bar)	30 psi (2.0 bar)	30 psi (2.0 bar)	30 psi (2.0 bar)	30 psi (2.0 bar)	30 psi (2.0 bar)	30 psi (2.0 bar)
	20-inch wheels	32 psi (2.2 bar)	32 psi (2.2 bar)	32 psi (2.2 bar)	32 psi (2.2 bar)	32 psi (2.2 bar)	32 psi (2.2 bar)	32 psi (2.2 bar)	32 psi (2.2 bar)
All-season tires	19-inch wheels	32 psi (2.2 bar)	32 psi (2.2 bar)	32 psi (2.2 bar)	32 psi (2.2 bar)	32 psi (2.2 bar)	32 psi (2.2 bar)	32 psi (2.2 bar)	32 psi (2.2 bar)
Snow tires	18-inch wheels	32 psi (2.2 bar)	32 psi (2.2 bar)	32 psi (2.2 bar)	32 psi (2.2 bar)				
	19-inch wheels	32 psi (2.2 bar)	32 psi (2.2 bar)	32 psi (2.2 bar)	32 psi (2.2 bar)	32 psi (2.2 bar)	32 psi (2.2 bar)	32 psi (2.2 bar)	32 psi (2.2 bar)
	20-inch wheels	32 psi (2.2 bar)	32 psi (2.2 bar)	32 psi (2.2 bar)	32 psi (2.2 bar)	32 psi (2.2 bar)	32 psi (2.2 bar)	32 psi (2.2 bar)	32 psi (2.2 bar)

- ▷ The load condition of the vehicle must be set on the multi-function display. The tire pressure must be changed according to the vehicle load. Please see the chapter “SELECTING “CHARGE” IN THE TIRE PRESSURE MENU” on page 130.

FA = front axle, RA = rear axle

Weights

	Panamera S	Panamera 4S	Panamera Turbo
Curb weight (depending on equipment)			
per DIN 70020	3968 lbs – 4497 lbs (1800 kg – 2040 kg)	4101 lbs – 4597 lbs (1860 kg – 2085 kg)	4343 lbs – 4729 lbs (1970 kg – 2145 kg)
per 70/156/EEC ¹⁾	4143 lbs – 4672 lbs (1875 kg – 2115 kg)	4276 lbs – 4772 lbs (1935 kg – 2160 kg)	4518 lbs – 4904 lbs (2045 kg – 2220 kg)
Maximum axle load, front ²⁾	2568 lbs (1165 kg)	2590 lbs (1175 kg)	2756 lbs (1250 kg)
Maximum axle load, rear ²⁾	2943 lbs (1335 kg)	2954 lbs (1340 kg)	2888 lbs (1310 kg)
Gross vehicle weight ²⁾	5302 lbs (2405 kg)	5379 lbs (2440 kg)	5512 lbs (2500 kg)
Roof load			
Maximum roof load ³⁾	175 lbs (75 kg)		

¹⁾ Curb weight includes 175 lbs (75 kg) driver and baggage.

²⁾ The maximum vehicle weight and maximum axle loads must not be exceeded.

Note: If additional accessories are installed, the maximum load will be correspondingly less.

³⁾ Only use roof transport systems from the Porsche Tequipment range for your vehicle or roof transport systems that have been tested and approved by Porsche.

Filling Capacities

Only use fluids and fuels approved by Porsche. Your authorized Porsche dealer can advise you.

Engine oil change quantity without/with oil filter	Approx. 2.17 US gallons (8.2 liters)/approx. 2.38 US gallons (9.0 liters)
Fuel tank	Panamera S: Approx. 80 litres, of which approx. 3.96 US gallons (15 liters) are reserve Panamera 4S, Panamera Turbo: Approx. 100 litres, including approx. 3.96 US gallons (15 liters) reserve
Fuel octane rating	The engine is designed to provide optimum performance and fuel consumption if unleaded premium fuel with 98 RON/88 MON (93 CLC or AKI) is used. If unleaded fuels with octane ratings of less than 98 RON/88 MON (93 CLC or AKI) are used, the engine's knock control automatically adapts the ignition timing. Porsche recommends that you use fuel with at least 95 RON/85 MON (90 CLC or AKI) in your vehicle.
Window/headlight cleaning system	Approx. 1.45 US gallons (5.5 liters)

Driving Performance

The specifications refer to a vehicle with DIN curb weight without performance-reducing additional equipment (e.g. special tires).

	Maximum speed	Acceleration 0 – 60 mph (96 km/h)	Acceleration 0 – 62 mph (100 km/h) (values in brackets relate to Sport Plus mode)
Panamera S	176 mph (283 km/h)	5.2 seconds	5.4 (5.2) seconds
Panamera 4S	175 mph/h (282 km)	4.8 seconds	5.0 (4.8) seconds
Panamera Turbo	188 mph (303 km/h)	4.0 seconds	4.2 (4.0) seconds

Dimensions

	Panamera S, Panamera 4S	Panamera Turbo
Length	195.67 in. (4970 mm)	
Width without exterior mirrors	76.02 in. (1931 mm)	
Width with exterior mirrors	83.23 in. (2114 mm)	
Height at DIN curb weight	55.83 in. (1418 mm)	
Wheelbase	114.96 in. (2920 mm)	
Ground clearance at maximum gross weight	3.31 in. (84 mm)	4.41 in. (112 mm)
Tracks		
18-inch wheels, front/rear	65.28 in. (1658 mm)/ 65.42 in. (1661.6 mm)	
19-inch wheels, front/rear	65.20 in. (1656 mm)/64.80 in. (1645.8 mm)	
20-inch wheels, front/rear	front: 64.80 in. (1646 mm) rear: 11J x 20 wheel, 64.24 in. (1631.8 mm) rear: 10.5J x 20 wheel, 64.48 in. (1637.8 mm)	

FarmaSOS.com

A		
ABD (automatic brake differential)		
Functional description	204	
ABS (anti-lock brake system)		
Functional description	207	
Warning light on instrument panel	207	
AC button		
Air-conditioning system	71	
AC MAX button		
Air-conditioning system	72	
ACC		
Adaptive cruise control	178	
Adaptive cruise control	178	
Display principle	181	
Exceptions	186	
Functional description	178	
Interrupting/resuming control	185	
Operating principle	180	
Operating states	182	
Radar sensor	178	
Setting the desired distance	183	
Setting/changing desired speed	182	
Switching on/off	182	
Warning messages	185	
Adaptive light system, driving light assistant	92	
Adhesive foils, care instructions	274	
Adjusting the opening height of the powerlift tailgate	30	
Aftermarket Alarms	190	
Air bag		
Air bag warning light in the instrument panel	51	
Automatic deactivation of the passenger air bag	50	
Care instructions	276	
Disposal	48	
Function	49	
Functional description	47	
Installation location	47	
Passenger air bag warning light	51	
Air cleaner, maintenance instructions	261	
Air suspension		
Overview	209	
Warning message on the multi-function display	210	
Air vents		
Adjusting	82	
Opening/closing	82	
Air-conditioning compressor		
Information on air-conditioning compressor	75	
Air-conditioning system		
Automatic load switch-off	75	
Child lock	80	
Defrosting windshield	73	
Extended ventilation panel	81	
Front control panel	76	
Functional description	76	
Information on air-conditioning compressor	75	
Rear control panel	77	
Setting air distribution	79	
Setting air quantity	79	
Setting automatic air-recirculation mode	75	
Setting temperature	78	
Switching AC MAX mode on/off	72	
Switching AC mode on/off	71	
Switching air-conditioning compressor on/off	71	
Switching air-recirculation mode on and off	74	
Switching automatic mode on/off	77	
Switching MONO mode on/off	74	
Switching REST mode on/off	71	
Temperature sensor	70	
Using engine residual heat	71	
Air-recirculation button		
Air-conditioning system	74	
Alarm button	19	
Alarm system		
Avoiding false alarms	249	
Functional description	247	
Persons/animals remaining in the locked vehicle	247	
Switching off	247	
Switching off alarm	247	
Switching off interior surveillance and inclination sensor	247	
Switching off passenger compartment monitoring system	248	
Switching on	247	
When disconnecting battery	304	
Alcantara, care instructions	276	
Alloy wheels		
Care instructions	274	
Inscription	289	
All-wheel drive		
Functional description	202	
Aluminum rims		
Care instructions	274	
Inscription	289	
Antifreeze		
In coolant	257	
In washer fluid	260	
Anti-lock brake system (ABS)		
Functional description	207	
Anti-slip control (ASR)		
Functional description	204	
Armrest		
Opening front storage tray	219	
Opening rear storage tray	220	
Ashtray		
Front, emptying	224	
Front, opening	224	
Rear, emptying	224	
Rear, opening	224	
ASR (Anti-slip control)		
Functional description	204	
Assistance when driving uphill		
Functional description	206	
Audio		
Tips	189	
Audio interface, installation position	192	
AUTO (light switch)	92	
Driving light assistant	92	
AUTO button		
Air-conditioning system	77	
Auto Start Stop function		
Display	170	
Exceptions	169	
Operating principle	169	
Preconditions	169	
Starting engine automatically	169	
Stopping engine automatically	169	

Switching on and off	170
Automatic (PDK transmission)	
Rocker switches on the steering wheel	61
Automatic brake differential (ABD)	
Functional description	204
Automatic driving light assistant	
Adaptive light system	92
Automatic headlight levelling	
Functional description	94
Automatic speed control (cruise control)	
Accelerating	177
Decelerating	177
Functional description	176
Interrupting operation	177
Storing speed	176
Switching off	178
Switching on	176
Automatic transmission	193
AUX interface, installation position	192
Auxiliary high-beam headlight	
Changing bulb	311
Installing headlights	309
Removing headlights	309

B

Baby seat	
Installing with LATCH system	56
LATCH restraint system	56
Prescribed installation direction (depending on weight of child)	53
Battery	191
Care	304
Changing in car key	307
Charge state	303
Charging	307
General information	303
Jump-lead starting	306
Location	303
Procedure after connection	305
Replacing	305
Vehicle electrical system voltage indication	113
Winter driving	304
Before driving off	4
Belt tensioner	
Functional description	45

Belts	44
Adjusting belt height	47
Belt tensioner functional description	45
Care instructions	276
Fastening	46
Opening	46
Warning light on the tachometer	45
Bi-Xenon headlight	
Changing bulb for auxiliary high-beam headlight	311
Installing headlights	309
Removing headlights	309
Brake booster	174
Brake fluid	
Changing	259
Warning light on speedometer	259
Brake pads	
Breaking in new brake pads	6
Warning message, brakes	174
Brake pedal	173
Brake wear	
Warning message	174
Brakes	
Applying/releasing parking brake	171
Brake pad warning message	174
Brake pedal	173
Brake wear warning message	174
Break in new brake pads	6
Footbrake	172
Test stand	253
Break in hints	6
Breaking in	
Engine	6
Engine oil and fuel consumption during break-in period	6
Hints	6
New brake pads and brake discs	6
New tires	6
Brief overview	
Air conditioning, front control panel	68
Air conditioning, rear control panel	69
Opening and locking the vehicle from outside	21
Windshield wipers	101
Bulbs	
Changing bulb for auxiliary high-beam headlight	311
Changing bulb for licence plate light	313
Changing bulb for side marker light	313

Changing bulb for side turn signal light	312
--	-----

C

Car care	
Air bags	276
Alcantara	276
Alloy wheels	274
Cleaning the engine compartment	272
Fabric linings	276
Headlights, plastic components, adhesive foils	274
Laying up your Porsche	276
Leather	275
Paint	271
Seals	275
Seat belts	276
Undercoating	273
Use of high-pressure cleaning equipment	270
Washing the vehicle, instructions	270
Wheel bolts	293
Windows	272
Car key (remote control)	
Emergency operation of key in ignition lock	166
Locking vehicle door	24
Unlocking vehicle door	23
Car Telephone	190
Care instructions	
Air bags	276
Alcantara	276
Alloy wheels	274
Car washing	270
Carpet	275
Cleaning the engine compartment	272
Fabric linings	276
Headlights, plastic components, adhesive foils	274
Laying up your Porsche	276
Leather	275
Mats	275
Paint	271
Radar sensor	274
Reversing camera	274
Seals	275
Seat belts	276
Ultrasound sensors, ParkAssist	274
Undercoating	273
Use of high-pressure cleaning equipment	270

Wheel bolts	293	Child seat bracket	56	Switching off	178
Windows	272	Chrono	135	Switching on	176
Carpet, care instructions	275	Cleaning the engine compartment	272	Cupholder	
Catalytic converter	263	Closing		Front	222
Emission control (Check Engine)	114	Closing slide/tilt roof	88	Rear	223
Center armrest		Closing tailgate automatically	28		
Opening rear storage tray	220	Locking vehicle door from inside	31		
Central locking	31	Persons/animals remaining in the vehicle	24		
Emergency operation in the event of a fault	35	Tailgate	26		
Locking vehicle door with car key (remote control)	24	Vehicle door with car key (remote control)	24		
Locking vehicle door with Porsche Entry & Drive	24	Vehicle door with Porsche Entry & Drive (keyless)	24		
Opening and locking vehicle door from inside	31	Cockpit			
Unlocking vehicle door with car key (remote control)	23	Adjusting lighting	95		
Unlocking vehicle door with Porsche Entry & Drive	23	Cooling system, temperature gauge	110		
Central locking system		Engine oil temperature gauge	110		
Functional description	20	Fuel gauge	111	Dimensions	330
When disconnecting battery	304	Odometer	112	Dimmer	
Changing bulb for licence plate light	313	Speedometer	110	Adjusting brightness of instrument lighting	95
Changing the remote control battery	307	Tachometer	110	Displacement, Technical data	324
Chassis control systems		Warning and indicator lights, overview	107	Display on multi-function display	
Overview (PTM, PSM, PASM, PDCC)	201	Comfort memory	40	Overview of warning messages	152
Chassis number, position	323	Comfort pressure		Display on the multi-function display	
Chassis setup		Selecting	131	Overview of warning messages	152
Functional description	208	Speed warning	131	Displaying average fuel consumption	120
Selecting	208	Compressor	279	Door	
Check Engine (emission control)		Control systems		De-icing door lock	270
Functional description	114	Overview (PTM, PSM, PASM, PDCC)	201	Locking if persons/animals are remaining in vehicle	24
Warning light	114	Coolant		Locking with car key (remote control)	24
Warning light on the tachometer	114	Antifreeze	257	Locking with Porsche Entry & Drive (keyless)	24
Child lock		Checking level	257	Malfunctions when opening and closing	35
Enabling/disabling opening rear doors from inside	32	Cooled glove box	219	Switching child lock for rear doors on/off	32
Enabling/Disabling power windows switches in the rear doors	88	Cooling system		Unlocking with car key (remote control)	23
Switching rear control panel on/off	80	Warning on multi-function display	110	Unlocking with Porsche Entry & Drive (keyless)	23
Child restraint anchorages	57	Cornering light		Door locking, automatic	25
Child restraint system		Dynamic	94	Door mirror	
Installing with LATCH system	56	Installing headlights	309	Adjusting	58
LATCH restraint system	56	Removing headlights	309	Adjusting as parking aid	60
Child seat		Static	94	Folding in	59
Installing with LATCH system	56	Courtesy lighting, Entry function	95	Folding out	59
LATCH restraint system	56	Crankcase ventilation	263	Storing settings (memory)	59
Prescribed installation direction (depending on weight of child)	53	Cruise control		Door opening	25
		Accelerating	177	Drinks holder	
		Decelerating	177	Front	222
		Functional description	176	Rear	223
		Interrupting operation	177	Drive-Off Assistant	206
		Storing speed	176	Driver memory	40
				Driving	
				Winter	199

Driving light assistant		Starting	167	ParkAssist	241
Adaptive light system	92	Starting automatically (Auto Start Stop function) ...	169	Power windows	88
Automatic headlight levelling, functional description	94	Starting manually (Auto Start Stop function)	169	Slide/tilt roof	89
Daytime driving lights	94	Stopping	168	When opening and closing	35
Dynamic cornering light	94	Stopping automatically (Auto Start Stop function)	169	Filler flap	
Low beam	93	Technical data	324	Emergency unlocking	267
Static cornering light	94	Engine drag torque control (MSR)		Filling capacities	
Switching on	92	Functional description	204	Coolant	329
Driving off		Engine oil	254	Engine oil	329
Launch Control	196	Change	256	Fuel	329
Driving performance, Technical data	329	Change quantity	329	Overview	329
DVD		Consumption	324	Overview of fluids and fuels	329
Installation location	191	Engine oil pressure	152	Washer fluid	329
Navigation	191	Filler opening	256	Filter	
Player	191	General information	254	Air cleaner, maintenance instructions	261
Dynamic cornering light	94	Oil-level warning on the multi-function display	255	Particle filter, maintenance instructions	261
E		Performance class	256	Fire extinguisher, storage location	321
Electric parking brake		Temperature gauge	110	First aid kit	279
Automatic parking brake release upon driving off	171	Topping up	255	Floor mats, care instructions	275
Emergency braking function	171	Viscosity	256	Fluids and fuels	
Operating	171	Entry & Drive		Coolant	329
Releasing	171	Locking vehicle door with Porsche Entry & Drive	24	Engine oil	329
Testing on brake test stand	253	Switching off interior surveillance with Porsche Entry & Drive	248	Fuel	329
Warning light	171	Unlocking vehicle door with Porsche Entry & Drive	23	Washer fluid	329
Emergency flasher		Entry function	95	Footbrake, safety notes	172
Switching emergency flasher on/off	97	Error messages		Four-wheel drive	
Emergency key	20	Overview of warning messages	152	Functional description	202
Emergency operation		Exhaust pipes	3	Front seat	
Of ignition key in ignition lock	166	Exterior mirror heating		Adjusting	39
Emergency unlocking		Switching on/off	84	Retrieving settings (memory)	41
Of filler flap	267	External audio source, interface	192	Storing settings (memory)	41
Of slide/tilt roof	89	F		Front seats	38
Of tailgate	35	Fabric linings (care instructions)	276	Front windshield wipers	
Emission control (Check Engine)		Fastening points in luggage compartment	227	Adjusting the rain sensor sensitivity	103
Functional description	114	Faults		Switching on rain sensor	102
Warning light on the tachometer	114	Emergency operation of ignition key in ignition lock	166	Windshield wiping plus washer system	102
Emission Control System	262	Emergency operation of powerlift tailgate	35	Windshield, fast wiping	102
Engine		Emergency operation of slide/tilt roof	89	Windshield, slow wiping	102
Break in hints	6	Emergency unlocking of the filler flap	267	Wiping windshield once (one-touch operation)	102
Checking oil level	121	Overview of warning messages	152	Fuel	
Cooling system	110			Economy	264
Oil-level gauge	121			Evaporation control	269

L

LATCH system	56	Loadspace	227	Checking engine-oil level	254
Fastening	56	Opening and closing the floor	227	Checking the coolant level and adding coolant.....	257
Installing a child seat.....	56	Overview	227	Notes on maintenance	252
Prescribed installation direction of child seat.....	53	Position of tie-down rings	227	Topping up engine oil	255
Launch Control.....	196	Lock, child lock		Malfunctions	
Leather, care instructions	275	Enabling/disabling opening rear doors from		Emergency operation of ignition key in ignition	
Level control		inside	32	lock.....	166
Overview	209	Enabling/disabling power windows switches in		Emergency operation of slide/tilt roof	89
Warning message on the multi-function display.....	210	the rear doors	88	Emergency operation of tailgate	35
Light		Switching rear control panel on/off.....	80	Emergency unlocking of the filler flap.....	267
Headlight flasher.....	96	Locking		Overview of warning messages	152
Switching on Welcome Home function	95	Emergency operation in the event of a fault.....	35	ParkAssist	241
Switching on when entering the vehicle.....	95	Locking the tailgate.....	26	Power windows	88
Light switch		Locking vehicle door from inside.....	31	Powerlift tailgate	30
AUTO function	92	Locking vehicle door with car key		When opening and closing.....	35
Overview	92	(remote control)	24	Memory	40
Switching on AUTO position	92	Locking vehicle door with Porsche Entry & Drive	24	Retrieving seat settings	41
Lights		Persons/animals remaining in the vehicle.....	24	Retrieving vehicle settings.....	41
Care instructions	274	Tailgate.....	26	Storing seat settings	41
Replacing Bulbs.....	308	Vehicle door with car key (remote control)	24	Storing vehicle settings.....	41
Switching front reading light on/off	98	Vehicle door with Porsche Entry & Drive (keyless).....	24	Memory buttons.....	41
Switching front reading lights on/off automatically..	99	Low beam		Minor repairs	
Switching on when entering the vehicle.....	95	Installing headlights	309	In the event of a flat tire	293
Switching on when leaving the vehicle	95	Removing headlights	309	Storage location of warning triangle.....	279
Load		Switching on/off	92	Mirrors	
Disengaging luggage compartment cover.....	231	Luggage		Adjusting exterior mirrors.....	58
General information on loading.....	228	General information on loading.....	228	Adjusting exterior mirrors as parking aid.....	60
Loading and securing ski bag	231	Loading and securing ski bag	231	Folding in exterior mirrors.....	59
Position of tie-down rings	227	Position of tie-down rings	227	Folding out exterior mirrors.....	59
Removing/installing retractable luggage		Retractable luggage compartment cover,		Storing exterior mirror settings (memory).....	59
compartment cover	229	pulling out/retracting	229	Switching automatic anti-dazzle function on	
Retractable luggage compartment cover,		Luggage compartment		and off	60
pulling out/retracting	229	Closing the tailgate	26	Vanity mirror	64
Loading		Opening and closing the floor	227	MONO button	
Disengaging luggage compartment cover.....	231	Opening the tailgate	25	Air-conditioning system	74
General information.....	228	Overview	227	Motion sensor (interior surveillance)	
Loading and securing ski bag	231	Position of tie-down rings.....	227	Switching off with button in door handle	
Position of tie-down rings	227	Luggage compartment cover		(Porsche Entry & Drive)	248
Removing/installing retractable luggage		Disengaging	231	Switching off with car key	247
compartment cover	229	M		Multi-function display	
Retractable luggage compartment cover,		Maintenance work		Activating functions, opening menus and	
pulling out/retracting	229	Adding washer fluid	259	viewing options	117
Loading information.....	236	Changing air cleaner	261	Browsing through long lists.....	117
		Changing particle filter	261	Checking oil level	121
				Display areas	116
				Menu overview	117

Operating navigation system.....	123
Operating principle.....	115
Operating with multi-function steering wheel.....	115
Operating with steering wheel lever.....	116
Overview of warning messages.....	152
Retrieving vehicle information.....	119
Selecting a radio station.....	123
Sport Chrono.....	136
Tire pressure warnings.....	133
Trip information.....	126
Using the telephone.....	125
Multi-function steering wheel	
Changing button assignment on multi-function steering wheel.....	151
Functional description.....	63
MFS button.....	116
With telephone function.....	63
N	
Navigation system.....	191
Using via multi-function display.....	123
O	
Octane rating.....	268
Octane rating, petrol.....	265
Odometer	
Display.....	112
Resetting.....	112
Off delay	
Switching on.....	95
Oil.....	254
Change.....	256
Change quantity.....	329
Checking level.....	121
Consumption.....	6
Filler opening.....	255
General information.....	254
Level gauge.....	121
Oil pressure.....	152
OilLevel warning on the multi-function display.....	255
Temperature gauge.....	110
Topping up.....	255

On-board computer	
Measuring oil level.....	121
Menu overview.....	117
Multi-function display.....	115
Operating principle.....	115
Overview of warning messages.....	152
Tire Pressure Monitoring.....	127
Opening and closing	
Closing tailgate automatically.....	28
Engine compartment lid.....	33
Locking vehicle door with car key (remote control).....	24
Locking vehicle door with Porsche Entry & Drive.....	24
Luggage compartment floor.....	227
Opening and locking vehicle door from inside.....	31
Opening tailgate automatically.....	27
Slide/tilt roof.....	88
Unlocking vehicle door with car key (remote control).....	23
Unlocking vehicle door with Porsche Entry & Drive.....	23
Opening and closing the engine compartment lid.....	33
Opening and closing the hood.....	33
Operating in other countries.....	264
Operating overview	
Air conditioning system, front.....	76
Operating the horn.....	61
Optical distortion, rear window.....	84
Oxygen sensor.....	263
Paint	
Care instructions.....	271
Polishing.....	271
Preserving.....	271
Removing spots and stains.....	271
Repairing damage.....	271
Panic button.....	19
ParkAssist	
Sensors.....	239
Parking	
Applying the parking brake.....	171
Locking the vehicle.....	24
PDK transmission.....	199

Parking aid	
Sensors.....	239
Swivelling down mirror glass.....	60
Parking brake	
Automatic parking brake release upon driving off.....	171
Operating.....	171
Releasing.....	171
Testing on brake test stand.....	253
Parking/pulling out	
Functional description, ParkAssist.....	239
Sensors for ParkAssist.....	239
Particle filter, maintenance instructions.....	261
PASM (Porsche Active Suspension Management)	
Functional description.....	208
Overview.....	201
Selecting chassis setup.....	208
Warning message on the multi-function display.....	208
Passenger air bag	
Automatic deactivation of the passenger air bag.....	50
Warning light in the center console.....	51
PASSENGER AIR BAG OFF	
Warning light in the center console.....	51
Passenger mirror	
Adjusting.....	58
Adjusting as parking aid.....	60
Folding in.....	59
Folding out.....	59
PCCB (Porsche Ceramic Composite Brake)	
General information.....	3
PCM (Porsche Communication Management).....	191
PDCC (Porsche Dynamic Chassis Control)	
Functional description.....	211
Overview.....	201
Warning message on the multi-function display.....	211
PDK selector lever	
Emergency unlocking.....	200
PDK transmission.....	193
Driving in winter.....	199
Faults.....	194
Kickdown.....	197
Reduced driving program.....	199
Rocker switches on the steering wheel.....	61
Selector-lever positions.....	195
Shifting gears on the steering wheel.....	196
Sport mode.....	195

Performance tests on roller-type test stands	253	Porsche Traction Management (PTM)	
Performance, Technical data	324	Functional description	202
Person buttons (memory)	41	Power steering	
Petrol		Checking and adding hydraulic fluid	260
Fuel can	267	Power windows	
Fuel gauge	111	Adjusting after connecting battery	88
Fuel reserve warning	112	Malfunctions	88
Octane rating	265	Opening/closing windows with rocker switch	86
Portable fuel containers	3	Overview of driver's door control panel	86
Quality	265	Overview of passenger's door control panel	86
Refuelling	265	Powerlift tailgate	
Tank capacity	329	Closing	28
Plastic components, care instructions	274	Opening	27
Porsche Active Suspension Management (PASM)		Safety notes	27
Air suspension and level control	209	Pressure	
Functional description	208	Tires (bar/psi)	326
Overview	201	Protection against towing (inclination sensor)	
Warning message on the multi-function display	208	Switching off with Porsche Entry & Drive	248
Porsche Ceramic Composite Brake (PCCB)		Switching off with remote control	247
General information	3	PSM (Porsche Stability Management)	
Porsche Communication Management (PCM)	191	Functional description	202
Porsche Doppelkupplung (PDK)	193	Multi-function light in the tachometer	205
Driving in winter	199	Overview	201
Faults	194	Switching off	204
Kickdown	197	Switching on	205
Launch Control	196	Warning light on the multi-function display	305
Reduced driving program	199	PTM (Porsche Traction Management)	
Selector-lever position	193	Functional description	202
Shifting gears on the steering wheel	196	Pulling out/parking	
Sport mode	195	Functional description, ParkAssist	239
Porsche Dynamic Chassis Control (PDCC)		Sensors for ParkAssist	239
Functional description	211	Push-starting	321
Overview	201		
Warning message on the multi-function display	211	R	
Porsche Entry & Drive		Radar sensor for adaptive cruise control	274
Inclination sensor	249	Radiator fan	
Interior surveillance	249	Installation position	258
Locking the vehicle	24	Safety notes	258
Unlocking the vehicle	23	Radio	
Porsche Stability Management (PSM)		Tips	189
Functional description	202	Radio remote control	19
Multi-function light in the tachometer	205	Rain sensor	
Overview	201	Adjusting	103
Switching off	204	Switching on	102
Switching on	205	Reading lights, front	
		Switching on/off	98
		Switching on/off automatically	99
		Rear fog light	
		Switching on	92
		Rear roll-up blind	66
		Rear seats	38
		Folding forward	226
		Rear spoiler, operating principle	214
		Rear window	
		Optical distortion	84
		Rear window wiper	
		Switching on intermittent operation	104
		Window wiping	104
		Rear-axle load	236
		Rearview camera	241
		Reduced driving program, PDK	199
		Refrigerated box in the rear of the vehicle, opening	226
		Refuelling	267
		Relays	
		Replacing	296
		Remote control	19
		Changing battery	307
		Locking vehicle door	24
		Unlocking vehicle door	23
		Removing/installing luggage compartment cover	229
		Replacement keys	19
		REST button	
		Air-conditioning system	71
		Restraint systems for children	
		Installing with LATCH system	56
		LATCH restraint system	56
		Prescribed installation direction (depending on age of child)	53
		Retractable rear spoiler	
		Extending and retracting	215
		Operating principle	214
		Roll stabilisation	
		Porsche Dynamic Chassis Control (PDCC)	211
		Roll-up blind	65
		Roll-up sunblind	
		For rear window, lowered automatically when reversing	66
		Raising/lowering for rear side windows	65
		Raising/lowering for rear window	66
		Roof load	328

Roof transport system	232	Settings		Start Stop function	169
Fitting basic carrier	233	Adjusting on multi-function display	138	Starting	
Roof load	328	Storing vehicle settings	40	Engine	167
Weights	328	Shifting gears		Starting engine automatically (Auto Start Stop function)	169
Running in		Porsche Doppelkupplung (PDK)	193	Steam-jet cleaners, instructions for use	270
Tires	6	Side lights		Steering column	
S		Installing headlights	309	Locking with Porsche Entry & Drive	165
Safety belts	44	Removing headlights	309	Locking without Porsche Entry & Drive	165
Adjusting belt height	47	Switching on	92	Steering column lock	
Belt tensioner functional description	45	Side marker light	313	With Porsche Entry & Drive	250
Fastening	46	Side marker light, changing bulb for side marker light	313	Without Porsche Entry & Drive	250
Opening	46	Side roll-up blind	65	Steering wheel	
Warning light on the tachometer	45	Side turn signal light	312	Adjustment	62
Safety button in the armrest		Ski bag		Airbag unit	61
Disabling rear control panel and power windows	80	Loading and securing	231	Changing button assignment on multi-function steering wheel	151
Safety compliance sticker	323	Stowing	231	Multi-function steering wheel with telephone function	63
Sealant/sealing set		Slide/Tilt roof		Multi-function steering wheel, functional description	63
For defective tires	293	Tool for emergency operation	279	Operating the horn	61
Seals, care instructions	275	Slide/tilt roof		PDK shift buttons	61
Seat belts		Emergency unlocking	89	Steering lock	164
Care instructions	276	Functional description	88	Switching Easy Entry function on/off	42
Seat memory	40	Malfunctions	89	Switching heating on/off	61
Seat ventilation	44	Snow chains		Stopping	
Switching off	44	General information	288	Engine	168
Switching on	44	Snow tires	287	Stopping engine automatically (Auto Start Stop function)	169
Seats		Changing tires	292	Stopwatch	135
Adjusting the front seat	39	Socket (12 V)	296	Storage	
Child restraint system	52	Speed code letter on tire	288	Glove box	218
Folding rear seats forward	226	Speed control (cruise control)		Opening storage compartment in front armrest ...	219
Front	38	Accelerating	177	Opening storage compartment in rear armrest ...	220
Rear	38	Decelerating	177	Storage options	218
Retrieving settings (memory)	41	Functional description	176	Storage compartment	
Storing settings (memory)	41	Interrupting operation	177	Glove box	218
Selector-lever position display, PDK transmission	194	Storing speed	176	In front armrest, opening	219
Setting air quantity		Switching off	178	In luggage compartment	221
Air-conditioning system	79	Switching on	176	In rear armrest, opening	220
Setting automatic air-recirculation mode		Speed limit	288	Storage	218
Air-conditioning system	75	Speedometer	110	Storage compartment	
Setting fan		Sport Chrono	135	Glove box	218
Air-conditioning system	79	Sport mode		In front armrest, opening	219
Setting temperature		Porsche Doppelkupplung	195	In luggage compartment	221
Air-conditioning system	78	Switching on/off	212	In rear armrest, opening	220
Setting the date	147	Stainless steel tailpipes		Storage	218
Setting the time	147	Care instructions	274	Summer tires	
		Standstill management		Changing tires	292
		Functional description	206	Storage	286
				Sun visor	64

Switching automatic anti-dazzle function on and off	60
Switching child protection on/off	
Disabling rear control panel and power windows	80
Switching MONO mode on/off	
Air-conditioning system	74
Switching on air-recirculation mode	
Air-conditioning system	74
Switching on parking light	96
T	
Tachometer	
Display	110
Tailgate	
Closing	26
Closing automatically	28
Opening	25
Opening automatically	27
Tailpipes	
Stainless steel, care instructions	274
Tank	
Ventilation system	269
Technical data	
Driving performance	329
Engine	324
Tire pressure (psi/bar)	326
Tires, wheels	325
Weights	328
Technical modifications to the vehicle, information	253
Telephone	190
Using via multi-function display	125
Test stands	
Brake test	253
Performance test	253
Theft protection	18
Tie-down rings	228
Tie-down rings, fastening points in luggage compartment	227
Tire	
Care	284
Life	283
Traction	281
Wear	283
Tire pressure	326
Air pressure (psi/bar)	326
Data (psi/bar)	326

Filling information	129
Selecting comfort pressure	131
Speed warning	131
System learning	134
Tire pressure plate	323
Tire type information	130
Warnings	133
Tire Pressure Monitoring (TPM)	127
Tire pressure plate	323
Tire sealant	279
Tire sealant/sealing set	
For defective tires	293
Tires	
Breaking in new tires	6
Changing	292
Damage	284
Fixing a flat tire	293
General information	280
Inscription on radial tire	288
Replacing	285
Rim offset	325
Sealant	293
Setting type and size	132
Sidewall	288
Size	325
Snow chains (general information)	288
Storage	286
Tire pressure plate	323
Tire pressure, data (psi/bar)	326
Valves	285
Winter tires (general information)	287
Tool kit	279
Tools	279
Torque, Technical data	324
Towing	
Screwing in towing lug	319
Towing lug in tool kit	279
Tow-starting	321
Tracks	330
Transmission	
Porsche Doppelkupplung (PDK)	193
Transmission and chassis control systems	
Overview (PTM, PSM, PASM, PDCC)	201
Transport (on car trains, ferries, etc.)	
Securing the vehicle	320
Switching off inclination sensor	247

Trip counter	
Display	112
Resetting	112
Trip information	126
Turn signal, changing side turn signal light	312
Turn signal, stalk	96

U

Ultrasound sensor, ParkAssist	239
Undercoating, care instructions	273
Universal audio interface, installation position	192
Unlocking	
Opening vehicle door from inside	31
Unlocking and opening tailgate	25
Unlocking vehicle door from inside	32
Unlocking vehicle door with car key (remote control) ..	23
Unlocking vehicle door with Porsche Entry & Drive (keyless)	23
Upshift prompt	112
USB interface, installation position	192
Using engine residual heat	71
Air-conditioning system	71

V

Vanity mirror	64
Vehicle	
Battery	191
Keys	19
Storage	304
Vehicle data	323
Vehicle door	
Locking from inside	31
Locking with car key (remote control)	24
Locking with Porsche Entry & Drive (keyless)	24
Malfunctions when opening and closing	35
Switching child lock for rear doors on/off	32
Unlocking with car key (remote control)	23
Unlocking with Porsche Entry & Drive (keyless)	23
Vehicle information	
Retrieving on multi-function display	119
Vehicle key (remote control)	
Changing battery	307

Vehicle settings			
Adapting multi-function display	139	Inscription on radial tire	288
Adjusting on multi-function display	138	Overview	325
Adjusting volume of warning and information tones	150	Replacing tires (general information)	285
Air-conditioning settings	146	Rim offset.....	325
Changing button assignment on multi-function steering wheel	151	Security wheel bolt (wrench socket)	293
Changing the language	150	Size	325
Light and vision settings	142	Snow chains (general information)	288
Locking settings	145	Storage	286
Resetting to factory settings	139	Tire pressure plate	323
Selecting settings menu	138	Tire pressure, data (psi/bar)	326
Setting date and time	147	Tire sealant	293
Setting units	149	Tracks	330
Storing on person buttons	40	Wheel balancing	285
Storing on the key	40	Wheel bolts (care instructions).....	293
Vents		Winter tires (general information)	287
Adjusting	82	Windows	
Opening/closing	82	Adjusting after connecting battery	88
Viscosity, engine oil	256	Care instructions.....	272
Voice control	192	Opening/closing with rocker switch	86
W		Windshield washer system	
Warning messages on multi-function display		Adding washer fluid	259
Overview	152	Antifreeze	259
Warning triangle (storage location)	279	Filling capacity	329
Washer fluid		Windshield wiper/washer stalk	102
Antifreeze.....	260	Rain sensor adjustment	103
Filling capacity	329	Rear window wiping	104
Topping up	259	Switching on intermittent operation of rear window wiper	104
Washing the vehicle, instructions	270	Switching on rain sensor	102
Weights		Windshield wiping plus washer system	102
Definitions	236	Windshield, fast wiping	102
Weights, Technical data	328	Windshield, slow wiping	102
Welcome Home function		Wiping windshield once (one-touch operation)	102
Switching on.....	95	Windshield wipers	
Wheel alignment	285	Brief overview	101
Wheel change	287	Care instructions.....	273
Wheels		Rain sensor adjustment	103
Adjusting	285	Rear window wiping	104
Changing	292	Stalk	102
Fixing a flat tire	293	Switching on intermittent operation of rear window wiper	104
General information.....	280	Switching on rain sensor	102
Inscription on alloy wheels	289	Windshield wiping plus washer system	102
		Windshield, fast wiping	102
		Windshield, slow wiping	102
		Wiping windshield once (one-touch operation)	102
		Winter driving	304
		Winter tires	
		General information	287
		Storage	286
		Wiper blades	
		Care instructions	273
		Wrench socket for security wheel bolt	
		Storage	279
		Using	293
		X	
		Xenon headlights	
		Changing bulb for auxiliary high-beam headlight ...	311
		Installing headlights	309
		Removing headlights	309